



# ***SpectraComm***

*V.F 28.8/33.6 Modem*

---

## *Installation & Operation Manual*

*060R112-000*

*Issue 10*

*April 2002*



**General DataComm**

*Smart Solutions for Service Providers*

## Copyright

©2002 General DataComm, Inc. ALL RIGHTS RESERVED.

This publication and the software it describes contain proprietary and confidential information. No part of this document may be copied, photocopied, reproduced, translated or reduced to any electronic or machine-readable format without prior written permission of General DataComm, Inc. The information in this document is subject to change without notice. General DataComm assumes no responsibility for any damages arising from the use of this document, including but not limited to, lost revenue, lost data, claims by third parties, or other damages.

If you have comments or suggestions concerning this manual, please contact:

General DataComm, Inc.  
Technical Publications  
6 Rubber Avenue  
Naugatuck, Connecticut USA 06770

Telephone: 1 203 729 0271

## Trademarks

All brand or product names are trademarks or registered trademarks of their respective companies or organizations.

## Documentation

### Revision History: GDC P/N 060R112-000

Issue Number	Date	Description of Change
1-4		Initial Release and Product Updates.
5	1997	Updated to Modem Firmware Version 5.0.3.0.
6 - 7 - 8	November 1999	Product Updates and Revised Manual Format.
9	July 2001	Added RADIUS Security option; Added V.34 4-Port model.
10	April 2002	Minor corrections and updates

### Related Publications

Description	GDC Part Number
GDC SpectraComm/UAS Installation & Operation for Shelf/Enclosure	010R302-REV
GDC SpectraComm 2000 Shelf Installation and Operation	010R358-REV
GDC Remote Access 1000 Enclosure Installation and Operation	010R111-REV
SpectraComm Manager Card Installation and Operation	048R303-REV
TEAM Core Software Operation Manual	058R720-REV
TEAM V.34 Operation Manual	058R716-VREF
V34 Dial Backup Unit Installation and Operation	060R113-REV
EP-5 DeskTop Cabinet	010R315-REV

**-REV** is the hardware revision (**-000**, **-001**, etc.)

**-VREF** is the most current software version (**-V400** is Version 4.0.0.)

In addition to the publications listed above, always read Release Notes supplied with your products.

# Preface

---

## Scope

This manual describes how to install, configure and operate the SpectraComm V.F 28.8 modem. It is written for technicians and users, and assumes a working knowledge of modem and telephone system technology. The information contained in this manual has been carefully checked and is believed to be entirely reliable. However, as General DataComm improves the reliability, function, and design of their products, it is possible that information may not be current. Contact General DataComm if you require updated information for this other General DataComm products.

General DataComm, Inc.  
6 Rubber Avenue  
Naugatuck, Connecticut, USA 06770  
Tel: 1 203 729 0271

## Manual Organization

This manual is divided into the following chapters:

*Chapter 1, Introduction and Specifications*

*Chapter 2, Installation*

*Chapter 3, Operation*

*Chapter 4, AT Command Set Operation*

*Chapter 5, V.25 bis Commands*

*Chapter 6, Tests*

*Appendix A, ASCII Character Set*

## Safety Information

This manual should be read in its entirety and all procedures completely understood before installing or operating the unit, including all notes, cautions and warnings (examples below). The CAUTION, WARNING, and DANGER statements that appear throughout this manual are intended to provide critical information for the safety of both the service engineer and operator. These statements also enhance equipment reliability. The following definitions and symbols for CAUTION, WARNING, and DANGER as they are used comply with ANSI Z535.2, American National Standard for Environmental and Facility Safety Signs, and ANSI Z535.4, Product Safety Signs and Labels, issued by the American National Standards Institute. .

---

**Note** *Indicates a note. It is something you should be particularly aware of; something not readily apparent. A note is typically used as a suggestion.*

---



---

**Important** *Indicates an emphasized note. It is something you should be particularly aware of; something not readily apparent. Important is typically used to prevent equipment damage.*

---



**CAUTION** *Indicates a potentially hazardous situation which, if not avoided, may result in minor to moderate injury. It may also be used to alert against unsafe practices.*



**WARNING** *indicates an imminently hazardous situation which, if not avoided, could result in death or serious injury.*



**DANGER** *indicates an imminently hazardous situation which, if not avoided, will result in death or serious injury.*

---

## Safety Guidelines

- Always use caution and common sense, especially when unsafe conditions or potentially hazardous voltages are present.
- Repairs must be performed by qualified service personnel only.
- To reduce the risk of electrical shock, do not operate equipment with the cover removed.
- Never install telephone jacks in a wet location unless the jack is designed for that location.
- Never touch uninsulated telephone wires or terminals unless the telephone line is disconnected at the network interface.
- Never install telephone wiring during an electrical storm.

## Antistatic Precautions

This product may contain static-sensitive devices that are easily damaged by electrostatic discharge (ESD). ESD occurs when a person whose body has built up static electricity touches a computer component. ESD can cause computer components to fail. Take proper handling, grounding and precautionary ESD measures installing parts or cards. Keep parts and cards in antistatic packaging when not in use or during transport. If possible, use antistatic pads on floor and workbench.

When handling components, always use an antistatic wrist strap connected to a grounded equipment frame or chassis. *If a wrist strap is not available, periodically touch an unpainted metal surface on the equipment.* Never use a conductive tool, like a screwdriver or a paper clip, to set switches.

## Compliance

### FCC Part 68

Connection of data communications equipment to the public telephone network is regulated by FCC Rules and Regulations. This equipment complies with Part 68 of these regulations which require all of the following:

All connections to the telephone network must be made using standard plugs and telephone company provided jacks or equivalent. Connection of this equipment to party lines and coin telephones is prohibited. A label on the component side of the unit's printed circuit board provides the FCC Registration number for the unit. If requested, give this information to the telephone company. To connect the product to the Public Telephone Network, you are required to give the following information to the telephone company:

- FCC Registration Number: AG6USA-75851-MD-E
- Facility Interface Codes: 04DU9-BN, 04DU9-DN, 04DU9-1KN, 04DU9-1SN
- Service Order Code: 6.0Y
- Telephone Company jack type: RJ48C

The telephone company may discontinue your service if the unit causes harm to the telephone network. If possible, you will be notified of such an action in advance. If advance notice is not practical, you will be notified as soon as possible and will be advised of your right to file a complaint with the FCC. The telephone company may change its communication facilities, equipment, operations and procedures where reasonably required for operation. If so, the telephone company will notify you in writing. All repairs or modifications to the equipment must be performed by General DataComm. Any other repair or modification by a user voids the FCC registration and the warranty.

### Part 15 Compliance

This device complies with Part 15 of the FCC rules. Operation is subject to the following two conditions:

1. This device may not cause harmful interference and
2. This device must accept any interference received, including interference that may cause undesired operation.

### Industry Canada Notification

The Industry Canada label identifies certified equipment. This certification means that the equipment meets telecommunications network protective, operation and safety requirements as prescribed in the appropriate Terminal Equipment Technical Requirements document(s). The Department does not guarantee the equipment will operate to the user's satisfaction.

Before installing this equipment, users should ensure that it is permissible to be connected to the facilities of the local telecommunications company. The equipment must also be installed using an acceptable method of connection. The customer should be aware that compliance with the above conditions may not prevent degradation of service in some situations.

Repairs to certified equipment should be coordinated by a representative designated by the supplier. Any repairs or alterations made by the user to this equipment, or equipment malfunctions, may give

the telecommunications company cause to request the user to disconnect the equipment.

Users should ensure for their own protection that the electrical ground connections of the power utility, telephone lines and internal metallic water pipe system, if present, are connected together. This precaution may be particularly important in rural areas.

**Caution:** Users should not attempt to make such connections themselves, but should contact the appropriate electric inspection authority, or electrician, as appropriate.

**Notice:** The Ringer Equivalence Number (REN) assigned to each terminal device provides an indication of the maximum number of terminals allowed to be connected to a telephone interface. The termination on an interface may consist of any combination of devices subject only to the requirement that the sum of the Ringer Equivalence Numbers of all the devices does not exceed 5.

## Electromagnetic Compatibility

This Class A digital apparatus complies with Canadian ICES-003.

## Avis D'industrie Canada

L'étiquette d'Industrie Canada identifie le matériel homologué. Cette étiquette certifie que le matériel est conforme aux normes de protection, d'exploitation et de sécurité des réseaux de télécommunications, comme le prescrivent les documents concernant les exigences techniques relatives au matériel terminal. Le Ministère n'assure toutefois pas que le matériel fonctionnera à la satisfaction de l'utilisateur.

Avant d'installer ce matériel, l'utilisateur doit s'assurer qu'il est permis de le raccorder aux installations de l'entreprise locale de télécommunication. Le matériel doit également être installé en suivant une méthode acceptée de raccordement. L'abonné ne doit pas oublier qu'il est possible que la conformité aux conditions énoncées ci-dessus n'empêche pas la dégradation du service dans certaines situations.

Les réparations de matériel homologué doivent être coordonnées par un représentant désigné par le fournisseur. L'entreprise de télécommunications peut demander à l'utilisateur de débrancher un appareil à la suite de réparations ou de modifications effectuées par l'utilisateur ou à cause de mauvais fonctionnement.

Pour sa propre protection, l'utilisateur doit s'assurer que tous les fils de mise à la terre de la source d'énergie électrique, des lignes téléphoniques et des canalisations d'eau métalliques, s'il y en a, sont raccordés ensemble. Cette précaution est particulièrement importante dans les régions rurales.

**Avertissement:** L'utilisateur ne doit pas tenter de faire ces raccordements lui-même; il doit avoir recours à un service d'inspection des installations électriques, ou à un électricien, selon le cas.

**Avis:** L'indice d'équivalence de la sonnerie (IES) assigné à chaque dispositif terminal indique le nombre maximal de terminaux qui peuvent être raccordés à une interface. La terminaison d'une interface téléphonique peut consister en une combinaison de quelques dispositifs, à la seule condition que la somme d'indices d'équivalence de la sonnerie de tous les dispositifs n'excède pas 5.

## La Compatibilité d'Électro-magnétique

Cet appareil numérique de la classe A est conforme à la norme NMB-003 du Canada.

## Deutschland

*Installations Anweisungen:* Installieren Sie die Telefonleitungen nicht während eines Gewitters. Installieren Sie die Telefonleitungen nicht in einem feuchten Raum, außer die Dose entspricht den Vorschriften für Feuchträume. Berühren Sie unisolierte Telefonleitungen oder Einrichtungen nicht, außer diese sind vom Telefonnetz getrennt. Vorsicht bei der Installation oder Änderung von Telefonleitungen. *Achtung:* Es gibt keine durch den Benutzer zu wartende Teile im Gerät. Wartung darf nur durch qualifiziertes Personal erfolgen.

## EC Declaration of Conformity

We: General DataComm Inc.  
6 Rubber Avenue  
Naugatuck, CT 06770, U.S.A.

Declare under our sole responsibility that the SpectraComm V.F 28.8\33.6 modem is in conformity with the following standards or other normative documents:

### EN 55022: 1994

Specification for limits and methods of measurement of radio interference characteristics of information technology equipment.

### EN 50082-1: 1992

Generic immunity standard Part 1 Residential, Commercial, and Light Industry, following the provisions of the Electromagnetic Directive, 89/336/EEC.

## Safety

### EN 60950: 1995 A1 through A3

Safety of Information Technology Equipment, following the provisions of the Low Voltage Directive, 73/23/EEC.

## Communications

CTR 15

CTR 17

Following the provisions of the Telecommunications Terminal Equipment Directive, 98/13/EEC.

## NEBS Compliance

Certified by independent labs for NEBS compliance to standards:

GR63 - Physical Protection

GR1089 - EMC and Safety

## Service Support and Training

VITAL Network Services is a leading single-source, data communications organization which provides network service and support for General DataComm customers throughout the world. Vital Network Services provides the support and training required to install, manage and maintain your GDC equipment. Training courses are available at centers in the US, UK, France, Singapore and Mexico, as well as at a customer's site.

For more information on VITAL Network Services or for technical support assistance, contact VITAL Network Services:

**VITAL Network Services World Headquarters**

6 Rubber Avenue  
Naugatuck, Connecticut 06770 USA

<http://www.vitalnetsvc.com>

Telephones:  
1 800 243 1030  
1 888 248 4825  
1 203 729 2461

Faxes:  
1 203 723 5012  
1 203 729 7611

<b>VITAL Network Services Regional Sales and Service Offices:</b>	
<p><b>North American Region Office</b> 6 Rubber Avenue Naugatuck, Connecticut 06770 USA Telephones: 1 800 243 1030 1 888 248 4825 1 203 729 2461 1 800 361 2552 (French Canadian) Training: 1 203 729 2461 Faxes: 1 203 723 5012 1 203 729 7611</p>	<p><b>Central America, Latin America</b> VITAL Network Services Periferico Sur 4225, Desp. 306 C.P. 14210, Mexico D.F., Mexico  Telephone: 52 5 645 2238 Training: 52 5 645 2238 Fax: 52 5 645 5976</p>
<p><b>Europe, Middle East, Africa</b> VITAL Network Services Molly Millars Close Molly Millars Lane Wokingham, Berkshire RG41 2QF UK  Telephone: 44 1189 657200 Training: 44 1189 657240 Fax: 44 1189 657279</p>	<p><b>Asia Pacific</b> VITAL Network Services 501 Orchard Road 05-05 Wheelock Place, Singapore 238880  Telephone: 65 735 2123 Training: 65 735 2123 Fax: 65 735 6889</p>



# Table of Contents

---

<a href="#">Manual Organization</a> .....	i
<a href="#">Safety Information</a> .....	ii
<a href="#">Compliance</a> .....	iii
<a href="#">Service Support and Training</a> .....	vi
<b><a href="#">Chapter 1: Introduction and Specifications</a></b>	
<a href="#">Product Overview</a> .....	1-1
<a href="#">Features and Benefits</a> .....	1-2
<a href="#">Diagnostics Overview</a> .....	1-3
<a href="#">SpectraComm V.F 28.8/33.6 Modem Models</a> .....	1-3
<a href="#">Shelf / Enclosure Options</a> .....	1-4
<a href="#">RADIUS Security Option</a> .....	1-5
<a href="#">Software Options</a> .....	1-5
<a href="#">Equipment List</a> .....	1-6
<a href="#">Technical Specifications</a> .....	1-9
<b><a href="#">Chapter 2: Installation</a></b>	
<a href="#">Unpacking and Setting Up the Modem</a> .....	2-1
<a href="#">Option Jumpers</a> .....	2-1
<a href="#">Plug-In Cards</a> .....	2-1
<a href="#">Installation Procedures</a> .....	2-3
<a href="#">Installation Guidelines</a> .....	2-3
<a href="#">Modem Installation</a> .....	2-3
<a href="#">Verifying Operation</a> .....	2-3
<a href="#">Cable Connections</a> .....	2-4
<a href="#">Special Considerations for High Data Rates</a> .....	2-11
<b><a href="#">Chapter 3: Operation</a></b>	
<a href="#">The V.F 28.8/33.6 Front Panel</a> .....	3-2
<a href="#">Front Panel Control Keys</a> .....	3-3
<a href="#">Front Panel Procedures</a> .....	3-4
<a href="#">Call Control Commands</a> .....	3-5
<a href="#">Call Initiation</a> .....	3-5
<a href="#">Completing a Connection</a> .....	3-7
<a href="#">Call Answering</a> .....	3-7
<a href="#">Password Security Overview</a> .....	3-9

## Table of Contents

<a href="#">Enabling Security in the Modem</a> .....	3-9
<a href="#">SteadFast Password Security</a> .....	3-11
<a href="#">Online Password Security</a> .....	3-12
<a href="#">RADIUS Security (Remote Authentication for Dial-In Users)</a> .....	3-14
<a href="#">Operation Modes and AT Commands</a> .....	3-15
<a href="#">AT Data Mode</a> .....	3-16
<a href="#">AT Command Mode</a> .....	3-17
<a href="#">Configuration Profiles</a> .....	3-18
<a href="#">Automatic DTE Speed and Parity Detection</a> .....	3-18
<a href="#">Remote Configuration Using the AT Commands</a> .....	3-19
<a href="#">Remote Configuration Using an MMS Controller</a> .....	3-20
<a href="#">Asynchronous Operation</a> .....	3-21
<a href="#">Error Correcting Modes</a> .....	3-22
<a href="#">Non-Error Correcting Modes</a> .....	3-25
<a href="#">Flow Control</a> .....	3-26
<a href="#">Synchronous Operation</a> .....	3-28
<a href="#">Synchronous Operating Modes</a> .....	3-28
<a href="#">Asynchronous Dialing with Synchronous Transmission</a> .....	3-28
<a href="#">Direct Dialing in Synchronous Mode</a> .....	3-28
<a href="#">Normal Synchronous Mode</a> .....	3-28
<a href="#">V.13 Synchronous Mode</a> .....	3-29
<a href="#">Synchronous Compression Mode</a> .....	3-29
<a href="#">Clock Selection</a> .....	3-30
<a href="#">Switched Network Operation</a> .....	3-31
<a href="#">Telephone Lines</a> .....	3-31
<a href="#">V.34 4-Port Operation</a> .....	3-32
<a href="#">Private Line Operation</a> .....	3-37
<a href="#">Two-wire or Four-wire Selection</a> .....	3-37
<a href="#">Other Configurations</a> .....	3-37
<a href="#">Transmit Level</a> .....	3-37
<a href="#">Automatic and Manual Handshaking</a> .....	3-38
<a href="#">Auto Dial Restoral</a> .....	3-38
<a href="#">Terminal Interface Function</a> .....	3-40
<a href="#">Initiating a Terminal Interface Session</a> .....	3-40
<a href="#">Selecting a Unit (Shelf Inventory Screen)</a> .....	3-41
<a href="#">AT Session</a> .....	3-42
<a href="#">Alarms</a> .....	3-44
<a href="#">Call Statistics</a> .....	3-45
<a href="#">DTE Status</a> .....	3-46

**Chapter 4: AT Command Set Operation**

<a href="#">AT Command Guidelines</a> .....	4-1
<a href="#">AT Command Procedures</a> .....	4-2
<a href="#">AT Command Reference Tables</a> .....	4-3
<a href="#">AT Command Details</a> .....	4-19
<a href="#">Special Considerations for \Tn Command</a> .....	4-19
<a href="#">Special Considerations for Asymmetrical DCE Rates</a> .....	4-19
<a href="#">&amp;Fn - Fixed Configuration Details</a> .....	4-20
<a href="#">\Vn Connect Messages Details</a> .....	4-23

**Chapter 5: V.25 bis Commands**

<a href="#">V.25 bis Command Overview</a> .....	5-1
<a href="#">V.25 bis Modes</a> .....	5-1
<a href="#">V.25 bis Command Responses</a> .....	5-3
<a href="#">108.2 Mode Interface Specifications</a> .....	5-4
<a href="#">_Asynchronous Format</a> .....	5-5
<a href="#">Modem Test Modes</a> .....	5-5
<a href="#">Commanding the Modem</a> .....	5-6
<a href="#">V.25 bis Configuration Commands</a> .....	5-6
<a href="#">V.25 bis Communication Commands</a> .....	5-9
<a href="#">V.25 bis Command Operating Procedures</a> .....	5-10
<a href="#">108.2 Mode Operating Procedures</a> .....	5-10
<a href="#">108.1 Mode Operating Procedures</a> .....	5-13

**Chapter 6: Tests**

<a href="#">Analog Loopback</a> .....	6-2
<a href="#">Analog Loopback Test Procedures</a> .....	6-3
<a href="#">Analog Loopback with Self-Test</a> .....	6-4
<a href="#">Analog Loopback Self-Test Procedures</a> .....	6-5
<a href="#">Digital Loopback</a> .....	6-6
<a href="#">Digital Loopback Test Procedures</a> .....	6-7
<a href="#">Remote Digital Loopback</a> .....	6-8
<a href="#">Remote Digital Loopback Procedures</a> .....	6-9
<a href="#">Remote Digital Loopback with Self-Test</a> .....	6-10
<a href="#">Remote Digital Loopback with Self-Test Procedures</a> .....	6-11
<a href="#">End-to-End Self-Test</a> .....	6-12
<a href="#">End-to-end Self-Test Procedures</a> .....	6-13

**Appendix A:ASCII Character Set**

## Table of Contents

# Chapter 1: Introduction and Specifications

## Product Overview

The SpectraComm V.F 28.8/33.6 is a universal, full-duplex, multi-speed modem that provides 33.6 kbps to 300 bps operation over the telephone (VF) line. It can be connected to a 2-wire switched line, a 2-wire private line, or a 4-wire private line. Up to 16 units can be installed in a compact, 7-inch high SpectraComm/UAS Shelf. Up to 10 units can be installed in a SpectraComm Enclosure.

The modem supports asynchronous or synchronous DTE data rates up to 128 kbps. Synchronous or character asynchronous operation is available at all speeds down to 1200 bps. Asynchronous operation is available at 0 to 300 bps. Synchronous rates above 28.8 kbps require the modem's synchronous data compression feature.

The modem provides automatic dial (AT Command) and automatic answer functions for switched network operation. The modem can be commanded from its local DTE using either the AT command set or the ITU-T V.25 *bis* command set. The AT commands can also be used for remote configuration performed through an off-site V.F 28.8/33.6 modem and DTE. The front panel buttons activate configuration and testing functions.

Modem software includes Management Information Base (MIB) files for modem control via Simple Network Management Protocol (SNMP) network controller. The GDC SpectraComm Manager Card (SCM) is required to access the MIBs.

## Supported Protocols

- V.34 for negotiated high-data-rate connections
- V.42 (LAPM) error correction
- V.42 *bis* data compression
- MNP-2 through MNP-4 error correction
- MNP-5 data compression
- MNP-10 cellular phone
- ITU-T (formerly CCITT) V.32 *bis*, V.32, V.22 *bis*, V.22, V.21
- Bell 212A and Bell 103 specifications

**Note** *Modem firmware versions from 5.0.3.0 have true ITU-T V.34 mode of operation, i.e.,*  
*-- Mode and compatibility commands now select V.34 (instead of GDC Fast)*  
*-- DCE rates are 2.4 to 33.6 kbps (previously 9.6 to 28.8 kbps)*  
*-- Compatible with all V.34-compliant modems*



## Features and Benefits

- Integral synchronous/asynchronous operation:  
Synchronous DTE rates to 33.6 kbps; Asynchronous DTE rates to 128 kbps,
- 2-wire, full-duplex, switched network operation with programmable or permissive transmit levels; 2- or 4-wire private line operation, with selectable transmit level.
- Automatic VF line rate determination in V.34 and V.32 *bis* modes, with fallforward/fallback.
- V.42/MNP error control.
- V.42 *bis*/MNP-5 asynchronous data compression.  
Synchronous data compression (supports rates up to 128 kbps).
- EIA/TIA-602 "AT" Command Set support.
- V.25 *bis* compatible command protocol support.
- Modem management via Simple Network Management Protocol (SNMP) control when operating in conjunction with the SpectraComm Manager (SCM).
- Remote configuration for changing a remote modem's user configuration profile.
- Front panel push buttons and Electronic Display Window for configuration and testing; Front panel status LEDs; Front panel lockout.
- Flash memory for downloading modem firmware.
- Permanent storage of modem configuration profiles in non-volatile memory.
- External, Internal, or Receiver Recovered transmit timing.
- Maximum line rate selection.
- Asynchronous character lengths of 8, 9, 10, and 11 bits.
- Password security via SteadFast (handshake) and/or Online cell passwords).  
Security Callback function to prevent unauthorized access to a remote modem.
- Intelligent Serial Terminal Dialer via the DTE interface, using the AT command set.
- Storage for up to ten telephone numbers for easy dialing.
- Pulse or tone dialing.
- Automatic answer.
- Diagnostics include: Analog Loopback with and without Self-Test features, Digital Loopback, Remote Digital Loopback, End-to-End Self-Test (511 or in FSK ALT pattern).
- Supports FAX Class 1 operation.
- When equipped with the V.34 DBU, provides dial backup for SpectraComm 521A DSUs, SpectraComm 500A DSUs and for SpectraComm 202 modems.
- When equipped with the V.34 4-Port, capable of selecting DTE Input/Output from four RS-561 Craft ports.
- When equipped with ADR, provides Auto Dial Restoral to restore a failed private line link over the switched network.
- When optioned at the factory for RADIUS, provides Remote Authentication for Dial In Service.

## Diagnostics Overview

The diagnostic tests included with the V.F 28.8/33.6 allow the user to accurately detect system faults and restore service quickly in the event of problems. Most tests can be controlled by front panel switches and are monitored via the front panel display and LEDs. Tests may also be controlled from a terminal or computer using AT commands, or from an SNMP controller. Refer to the subsequent chapters in this manual for commands and procedures.

Diagnostics tests include: Local Loop (ANALOOB), Local Loop Self-Test (ANALOOB Self-Test), Digital Loopback, Remote Digital Loopback, Remote Digital Loopback Self-Test, and End-to-End Self-Test.

## SpectraComm V.F 28.8/33.6 Modem Models

Models of the V.F 28.8/33.6 modem are described briefly below. Each model of the V.28.8/33.6 modem can also be optioned at the factory for the [RADIUS Security Option](#). Refer to [Table 1-1](#) for descriptions and part numbers for all models, standard equipment and options of the V.F 28.8/33.6 modem.

### V.34 Dial Only Model

The basic model of the V.28.8/33.6 modem is Dial Only. The basic model provides a built-in TIA/EIA-232-F DTE interface (ITU-T V.24/V.28/ISO 2110). When equipped with one of two available DTE plug-in cards, the basic model can provide a ITU-T V.35 DTE interface or a EIA RS-530A DTE interface. DTE plug-ins are found in [Chapter 2: DTE Interface Plug-in Card](#).

---

**Note** *A V.34 4-Dial Only modem can be ordered from the factory with RADIUS Authentication or can be optioned for RADIUS at the factory at a later time.*

---

### V.34 4-Port Model

The V.34 4-Port model of the V.F 28.8/33.6 modem allows an authorized user to select an RS-561 interface to one of four ports (to DTEs or DCEs). Access to the 4-Port function is protected by cell password security or RADIUS security authentication. The V.34 4-Port requires modem firmware version 7.1.0 or higher and consists of an external V.34 4-Port Adapter and a plug-in card on the base card. Note that when connecting a port to a DCE, a RS-561 null cable is required. To upgrade an existing modem to 4-port capability, consult your GDC sales representative.

---

**Note** *A V.34 4-Port modem can be ordered from the factory with RADIUS Authentication or can be optioned for RADIUS at the factory at a later time.*

---

### V.34 DBU Model

The V.34 DBU model of the modem provides the Dial Backup function for SpectraComm 521A DSUs, SpectraComm 500A DSUs and for SpectraComm 202 modems. This model does not accept V.35 or EIA/TIA-530 plug-in cards.

### V.34 ADR Model

The V.34 ADR model provides the Auto Dial Restoral function for restoring failed 2- and 4- wire private line links over the switched network. This model can accept RS-530 and V.35 interface plug-in cards.

### Shelf / Enclosure Options

[Figure 1-1](#) shows shelf and enclosure configurations for any model of the V.F 28.8/33.6 modem. Up to 31 modems can be accommodated in a shelf/enclosure configuration, alone or with other types of network elements. Refer to [Table 1-1](#) for shelf / enclosure descriptions and part numbers. For more information on any shelf / enclosure system, refer to its manual as listed on the inside cover of this manual.

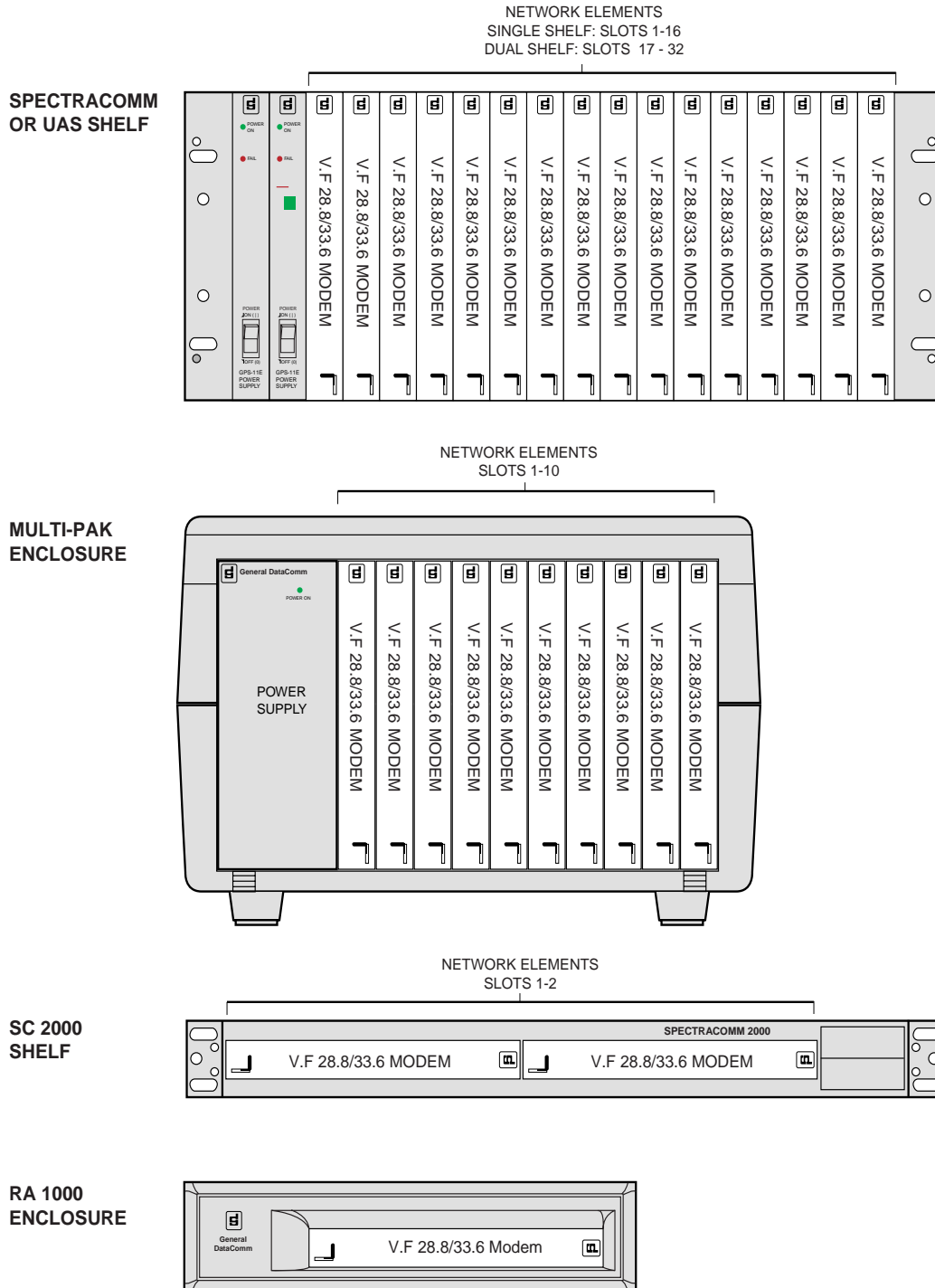

**Figure 1-1** Shelf / Enclosure Configurations



## RADIUS Security Option

When optioned at the factory, the SpectraComm V.F 28.8/33.6 modem can support RADIUS (Remote Authentication for Dial-In User Service). RADIUS is an optional software feature for the SCM card which allows the modem to provide secure dial-in serial connections for remote management of network elements. In a RADIUS protected system, dial-in users will be authenticated through user names, passwords, and challenged prompts coming from the modem and through the SCM card over the shelf management bus. A V.F 28.8/33.6 modem can be optioned for RADIUS at the time of sale, or a field unit can be optioned for RADIUS at the factory at a later date.

- Refer to the section on [RADIUS Security \(Remote Authentication for Dial-In Users\)](#) in this document for additional modem-related information on RADIUS Security.
- For detailed RADIUS installation and operation information, refer to the SpectraComm Manager Card Manual (*GDC P/N 048R303-000*), *Appendix B: SCM with RADIUS*.

## Software Options

### Communication Software

Two types of customer-supplied communication software can be used with the V.F 28.8/33.6 modem:

- terminal emulation software
- data communications software

To take full advantage of the features of the V.F 28.8/33.6, the software program you select for use with the modem should allow turning off the autobaud feature. You should also be able to toggle both XON/XOFF and hardware flow control. In addition, it should support several file transfer protocols designed to be used with an error-correcting modem.

A full-featured data communications software package permits file transfer, a dial directory, a script language for automated sessions, etc. Terminal emulation software, however, communicates with main-frame or mini-computers to allow keyboard input and video display/printer output, but generally does not support disk management or file transfers.

### V.F 28.8/33.6 Modem Drivers

The V.F 28.8/33.6 modem is designed to interface seamlessly with Windows 95, Windows 98, Windows 2000, and NT 4.0 by means of a dedicated modem device driver. Point your browser to the GDC internet site at [www.gdc.com](http://www.gdc.com) to download and install the GDC V.34 Modem driver GDCV34.inf. To update your modem drivers, from the GDC home page, click on **Download software: V.34 modems** and then click on **Read inf.txt** for complete instructions.

## Equipment List

[Table 1-1](#) describes standard and optional equipment and part numbers for the SpectraComm V.F 28.8/33.6 modem. [Table 1-2](#) lists country-specific VF plug-in cards and their part numbers.

- The V.34 Dial Only modem and the V.34 4-Port modem can be ordered with RADIUS Authentication, or can be optioned for RADIUS at the factory at a later time.
- Unless otherwise stated, SC MultiPak Enclosure systems include one enclosure, one power supply, and one ac power cord.
- Unless otherwise stated, SC/UAS shelf systems include one base shelf, one power supply and power supply blank front panel, Zone 1 connector panel(s), one 16-slot DB25 Zone 3 connector panel, two standard mounting brackets, and assorted mounting hardware.
- Cable part numbers may include an -XXX suffix which designates the length in feet.

**Table 1-1** SpectraComm V.F 28.8/33.6 Equipment List

item	Description	GDC Part No.
Dial Only V.34 Modems	V.F 28.8/33.6 Modem, switched network with TIA/EIA-232-F DTE interface (built-in)	060P012-001
	V.F 28.8/33.6 Stand-alone Modem, switched network with TIA/EIA-232-F DTE interface (built-in)	060A012-015
	V.F 28.8/33.6 Modem, switched network with V.35 DTE Interface card	060M012-211
	V.F 28.8/33.6 Modem, switched network with EIA/TIA-530A DTE Interface card	060M012-311
ADR V.34 Modem and Interface Cards	V.F 28.8/33.6 Modem, switched network and private line with TIA/EIA-232-F DTE interface (built-in)	060M012-001
	V.F 28.8/33.6 Stand-alone Modem switched network and private line with TIA/EIA-232-F DTE interface (built-in)	060A012-005
	DTE Interface Card, EIA/TIA-530-A (ITU-T V.10/V.11/V.24/ISO 2110 Amendment 1)	060P017-001
	DTE Interface Card, ITU-T V.35 (ITU-T V.24/V.28/V.35/ISO 2593)	060P016-001
International V.34 Modem and Interface Cards	V.F 28.8/33.6 Modem, switched network and private line, TIA/EIA-232-F DTE interface. (Refer to <a href="#">Table 1-2</a> for country-coded part numbers.)	060M012[X]001
	DTE Interface Card, EIA/TIA-530-A (ITU-T V.10/V.11/V.24/ISO 2110 Amendment 1)	060P017-001
	DTE Interface Card, ITU-T V.35 (ITU-T V.24/V.28/V.35/ISO 2593)	060P016-001
	VF Interface Card (Refer to <a href="#">Table 1-2</a> for country-coded part numbers.)	060P015[X]001
		060P018[X]001
060P019[X]001		
V.34 DBU Modem	V.F 28.8/33.6 Modem, switched network with TIA/EIA-232-F DTE interface (built-in) with DBU Plug-in Card	060M012-411
	V.F 28.8/33.6 Stand-alone Modem, switched network with TIA/EIA-232-F DTE interface (built-in) with DBU Plug-in Card	060A012-415
V.34 4-Port Modem	V.F 28.8/33.6 Modem, switched network with TIA/EIA-232-F DTE interface (built-in) with V.34 4-Port Card Set	060M012-511
	V.F 28.8/33.6 Stand-alone Modem, switched network with TIA/EIA-232-F DTE interface (built-in) with V.34 4-Port Card Set	060A012-515
V.34 4-Port Card Set	4-Port External Adapter; Cannot be ordered separately from modem.	060P022-001
	4-Port Plug-in Card; Cannot be ordered separately from modem.	060P023-001
RADIUS Option	Security option for Remote Authentication for Dial In Users (Option code: SECDOSDC) Optioned at the factory for any model of the V.F 28.8/33.6 modem.	060U500-D04 (order with any modem model)

**Table 1-1** SpectraComm V.F 28.8/33.6 Equipment List (Continued)

item	Description	GDC Part No.
EP-5 Cabinets	EP-5 DeskTop Cabinet with door, 100/120 V ac	010C356-001
	EP-5 DeskTop Cabinet with door, 220/240 V ac	010C356-002
SpectraComm MultiPak Enclosure ME-2	Model 1 (100/120 V ac); includes DB25 Zone 3 connectors	010B163-001
	Model 2 (100/120 V ac); includes V.35 Zone 3 connectors	010B164-001
	Model 3 (220/240 V ac, international); includes DB25 Zone 3 connectors; line cord optional, specify type	010B163-002
	Model 4 (220/240 V ac, international); includes V.35 Zone 3 connectors; line cord optional, specify type	010B164-002
SpectraComm Shelf MS-2	Model 1 (100/120 V ac); includes two 8-slot, dual RJ45 Zone 1 connector panels	010M054-001
	Model 2 (-48 V dc); includes two 8-slot, dual RJ45 Zone 1 connector panels	010M055-001
	Model 3 (220/240 V ac, international); includes two 8-slot, dual RJ45 Zone 1 connector panels	010M056-001
	Model 4 (100/120 V ac); includes one 16-slot, 50-pin/wire wrap Zone 1 connector panel	010M057-001
	Model 5 (-48 V dc); includes one 16-slot, 50-pin/wire wrap Zone 1 connector panel	010M058-001
	Model 6 (220/240 V ac, international); includes one 16-slot, 50-pin/wire wrap Zone 1 connector panel	010M059-001
	Model 10 (-48 V dc, with redundant power supplies); includes two 8-slot, dual RJ45 Zone 1 connector panels	010M070-001
	Model 11 (-48 V dc, with redundant power supplies); includes one 16-slot, 50-pin/wire wrap Zone 1 connector panel	010M071-001
RA1000 Enclosure	Remote access stand-alone enclosure (100-250 V ac) for one card	010B236-001
DTE Cables (Business Equipment)	Adapter Cable, EIA/TIA-232-F (25-pin male) to ITU-T V.35 (34-pin female)	027H572-001
	Cable, EIA/TIA-232-F, DB25 male to DB25 male, S/T	028H502-XXX
	Extender Cable, TIA/EIA-232-F, DB25 male to DB25 female, S/T	028H506-XXX
	Cable, EIA/TIA-232-F, DB25 male to DB25 female, S/T	028H511-XXX
	Cable, EIA/TIA-530-A, DB25 male to DB25 male, S/T	027H525-XXX
	Cable, ITU-T (ISO 2593) V.35 34-pin male to male, S/T	027H516-XXX
	Cable, EIA-561, RJ45 to RJ45 S/T, unkeyed	830-128-807
	Cable, EIA-561 RJ45 to RJ45 crossover, 3-wire unkeyed	021H104-XXX
	Adapter, DB25 male to V.35 34-pin female	209-036-025
	Adapter, EIA-561 RJ45 female to DB-25 male	029H210-001
	Adapter, EIA-561 RJ45 female to DB9 female	029H211-001
Network Cables	Cable, Switched network permissive connection, with 6-position modular plugs	830-027-XXX
	Cable, Switched network programmable connection, also used for Private line four-wire cable with 8-position keyed modular plugs	830-028-XXX
	Cable, Private line with 8-position to 8-position unkeyed modular plugs	024H207-XXX
Power Cables (For Shelves, Enclosures, and Cabinets)	Domestic 100/120 V ac power cord (SpectraComm Shelf only)	830-002-002
	Domestic 100/120 V ac power cord	830-024-003
	European 220/240 V ac power cord	830-061-002
	UK 220/240 V ac power cord	830-060-102

## Country Codes

The following table lists VF plug-in cards according to their country codes and their part numbers. Country code certifications are subject to change without notice. For the current product status, refer to the GDC website at <http://www.gdc.com/Products/Homologation>.

- Country codes listed below with an asterisk (\*) indicate VF plug-in cards with country codes that are not included in the released D-code.
- Country codes listed as 999 (default) indicate no dialing parameters.

**Table 1-2** Country Code Part Numbers

Country	Code	Part Number
Argentina	54	060M012B001
Australia	61	060M012D001
Austria	43	060M012N001
Bahrain	973	060M012A001
Belgium	32	060M012H001
Bolivia	591	060M012B001
Brazil	55	060M012B001
Bulgaria	*359	
Chile	56	060M012B001
China	86	060M012A001
Colombia	57	060M012B001
Costa Rica	506	060M012B001
Cyprus	357	060M012C001
Czechoslovakia	42	060M012N001
Denmark	45	060M012H001
Ecuador	593	060M012A001
El Salvador	504	060M012B001
Egypt	20	060M012A001
Finland	358	060M012C001
France	33	060M012R001
Germany	49	060M012L001
Greece	30	060M012A001
Guatemala	502	060M012B001
Hong Kong	852	060M012A001
Hungary	36	060M012N001
India	91	060M012A001
Indonesia	62	060M012B001
Ireland	353	060M012U001
Israel	972	060M012A001
Italy	39	060M012J001
Japan	81	060M012K001
Kuwait	965	060M012A001
Lebanon	961	060M012A001

Country	Code	Part Number
Luxembourg	352	060M012H001
Malaysia	60	060M012A001
Mexico	52	060M012B001
Netherlands	31	060M012C001
New Zealand	64	060M012G001
Norway	47	060M012E001
Oman	968	060M012A001
Panama	507	060M012B001
Peru	51	060M012B001
Philippines	63	060M012A001
Poland	48	060M012N001
Portugal	351	060M012H001
Puerto Rico	999	060M012B001
Romania	*48	060M012N001
Russia	7	060M012B001
Saudi Arabia	966	060M012A001
Singapore	65	060M012H001
Slovakia	428	060M012A001
Slovenia	386	060M012L001
South Africa	27	060M012A001
South Korea	82	060M012A001
Spain	34	060M012M001
Sweden	46	060M012F001
Switzerland	41	060M012P001
Taiwan	886	060M012B001
Thailand	66	060M012B001
Trinidad	888	060M012B001
Turkey	90	060M012A001
U.A.E.	971	060M012A001
U.K.	44	060M012U001
Uruguay	598	060M012B001
Venezuela	58	060M012B001

## Technical Specifications

**Table 1-3** SpectraComm V.F 28.8/33.6 Modem Specifications

Item	Specification	
VF Data Rate	33.6 kbps (ITU-T V.34)	Synchronous/asynchronous
	31.2 kbps (ITU-T V.34)	Synchronous/asynchronous
	28.8 kbps (ITU-T V.34)	Synchronous/asynchronous
	26.4 kbps (ITU-T V.34)	Synchronous/asynchronous
	24.0 kbps (ITU-T V.34)	Synchronous/asynchronous
	21.6 kbps (ITU-T V.34)	Synchronous/asynchronous
	19.2 kbps (ITU-T V.34)	Synchronous/asynchronous
	16.8 kbps (ITU-T V.34)	Synchronous/asynchronous
	14.4 kbps (ITU-T V.34 or V.32 <i>bis</i> )	Synchronous/asynchronous
	12.0 kbps (ITU-T V.34 or V.32 <i>bis</i> )	Synchronous/asynchronous
	9600 bps (ITU-T V.34 or V.32)	Synchronous/asynchronous
	7200 bps (ITU-T V.34 or V.32 <i>bis</i> )	Synchronous/asynchronous
	4800 bps (ITU-T V.34 or V.32)	Synchronous/asynchronous
	2400 bps (ITU-T V.34 or V.22 <i>bis</i> )	Synchronous/asynchronous
	1200 bps (ITU-T V.22 or Bell 212A)	Synchronous/asynchronous
	300 bps (ITU-T V.21)	Asynchronous only
	300 bps (Bell 103)	Asynchronous only
Data Format	Bit synchronous	
	Bit asynchronous	Selectable 8, 9, 10, or 11 bits per character
Transmit Clock	Internal, External, or Receive Wrap	
Compatibility	ITU-T V.34, V.32 <i>bis</i> , V.32, V.22 <i>bis</i> , V.22, V.21, Bell 212A, and Bell 103	
Operating Mode	Switched network	Two-wire full duplex
	Private line	Two-wire or four-wire
Modulation	2400 bps to 33.6 kbps	As specified by ITU-T V.34
	9600 bps	16-level QAM/2400 Baud $\pm 0.01\%$
	7200 bps	16-level TCM/2400 Baud $\pm 0.01\%$
	4800 bps	4-level QAM/2400 Baud $\pm 0.01\%$
	2400 bps	16-level QAM/600 Baud $\pm 0.01\%$
	1200 bps	4-level PSK/600 Baud $\pm 0.01\%$
	0-300 bps	FSK 0-300 Baud $\pm 0.01\%$
Answer Tone	ITU-T V.32 <i>bis</i> , V.32, V.22 <i>bis</i> , V.22 and V.21 modes	2100 Hz $\pm 3$ Hz
	Bell 212A and 103 modes	2225 Hz $\pm 3$ Hz
	ITU-T V.34	As specified by ITU-T

**Table 1-3** SpectraComm V.F 28.8/33.6 Modem Specifications (Continued)

Item		Specification
Transmit Carrier	ITU-T V.34	As specified by ITU-T
	ITU-T V.32 <i>bis</i>	As specified by ITU-T
	ITU-T V.32	As specified by ITU-T
	ITU-T V.22, V.22 <i>bis</i> /Bell 212A Originate Mode Answer Mode	1200 Hz $\pm$ 0.5 Hz 2400 Hz $\pm$ 1 Hz
	ITU-T V.21 Originate Mode Answer Mode	Mark                      Space 1180 Hz $\pm$ 12 Hz    980 Hz $\pm$ 12 1850 $\pm$ 12 Hz        1650 $\pm$ 12 Hz
	Bell 103 Originate Mode Answer Mode	Mark                      Space 1270 Hz $\pm$ 12 Hz    1070 Hz $\pm$ 12 Hz 2225 Hz $\pm$ 12 Hz    2025 Hz $\pm$ 12 Hz
Output Level	Permissive	-9 dBm maximum or per country requirements. -10 dBm to -31 dBm for MNP-10
	Programmable	-6 to -12 dBm (U.S. Only)
	Note: Receiver performance in ITU-T V.34, V.32 <i>bis</i> , and V.32 modes may be degraded when transmitting above -6dBm.	
Receive Carrier	ITU-T V.34	As specified by ITU-T
	ITU-T V.32 <i>bis</i>	As specified by ITU-T
	ITU-T V.32	As specified by ITU-T
	ITU-T V.22 <i>bis</i> /Bell 212A Originate Mode Answer Mode	2400 Hz $\pm$ 7 Hz 1200 Hz $\pm$ 7 Hz
	ITU-T V.21 Originate Mode Answer Mode	MarkSpace 1850 $\pm$ 12 Hz1650 $\pm$ 12 Hz 1180 Hz $\pm$ 12 Hz1650 Hz $\pm$ 12 Hz
	Bell 103 Originate Mode Answer Mode	MarkSpace 2225 Hz $\pm$ 12 Hz2025 Hz $\pm$ 12 Hz 1270 Hz $\pm$ 12 Hz1070 Hz $\pm$ 12 Hz
	Note: ITU-T V.34/V.32/V.32 <i>bis</i> , being echo canceling protocols use signal quality as criteria for maintaining connection. They also provide for self-training detection to force disconnect.	
Receive Level	Switched Network	-6 to -43 dBm
	Two-wire Private Line	-6 to -33 dBm
	Four-wire Private Line	0 to -26 dBm
Carrier Detect	(Level for ITU-T V.22 <i>bis</i> , V.22, V.21, 212, 103) in Switched Network	
	Acquisition: -43 dBm	Release: -48 dBm
Hysteresis	2 dBm minimum	
DTE Interface	Standard	EIA/TIA-232-E (ITU-T V.24/V.28/ISO 2110)
	Optional	EIA/TIA-530-A (ITU-T V.10/V.24/ISO 2110 Amendment 1) V.35 (ITU-T V.24/V.28/V.35/ISO 2593) V.36 (requires optional cable)

**Table 1-3** SpectraComm V.F 28.8/33.6 Modem Specifications (Continued)

Item		Specification
Line Requirements	Switched Network	Two-wire
	Private Line	Two-wire or four-wire
Line Connection	Switched Network	8-position modular jack (US RJ45)
	Phone	6-position modular jack (US RJ11)
	Private Line	8-position modular jack (US RJ45)
Line Impedance	600 ohms or 900 ohms	
Line Equalization	Automatic Adaptive	
Connection Options	One second Line Break Holdover in four-wire private line mode only.	
	Loss of Carrier in ITU-T V.22 bis and lower.	
	Loop Current Disconnect.	
Phone Types	500/503 (rotary dial), 2500/2503 (DTMF dial), and no phone	
Dialing	Pulse and Tone	
DTMF Output Level	USA	Per Part 68
	International	per country requirements
Pulse Dial Ratio	USA	Make/Break: 39/61%
	International	per country requirements
Ring Cadence	USA	On 2 seconds; Off 4 seconds
	International	per country requirements
DC Loop Current	USA	20-80 milliamps
	International	per country requirements
Call Progress Monitor	BUSY	
	CONNECT (rate)	See ITU-T V.42 options for delay
	CONNECT	See ITU-T V.42 options for delay
	NO ANSWER	
	NO CARRIER	
	NO DIALTONE	
	OK (character abort)	
	RING	
	RINGING	
	UNOBTAINABLE NUMBER	
Power Consumption	6 card-edge watts dc maximum	Load Number = 1
DC Voltage (Typical)	+5V	+5V $\pm$ 5% at 1A
	+12V	+12V $\pm$ 5% at 0.2A
	-12V	-12V $\pm$ 5% at 0.2A
Dimensions (Printed circuit board)	Height	21 mm (0.81 in)
	Width	178 mm (7.0 in)
	Depth	241 mm (9.5 in)
Temperature	Operating	0 to 50°C (32° to 122°F)
	Non-operating	-40 to 70°C (-40° to 158°F)
Humidity, operating	Up to 95 % humidity (non-condensing)	
Altitude, operating	0 m to 3,047 m (0 to 10,000 ft)	





# Chapter 2: Installation

---

## Unpacking and Setting Up the Modem

The SpectraComm V.F 28.8/33.6 modem is shipped pre-assembled, tested, and ready to use. Inspect the unit when received and notify the shipper of any damage immediately. Keep the box and packing material to reship the unit as needed. After inspection, perform the installation, cabling and power up procedures described in this chapter.

### Option Jumpers

The V.F 28.8/33.6 has only one user-configurable option jumper, **X2**, which sets the line termination impedance in switched network mode. Note that the impedance in private line mode is fixed at 600 ohms, which is the factory default setting. There are three other factory-set jumpers: **X1**, **X3** and **X4**. Verify that they are set as shown in [Figure 2-1](#).

### Plug-In Cards

Some models of the V.F 28.8/33.6 modem come equipped from the factory with plug-ins on the base card. The following paragraphs briefly describe the board layout with these plug-ins. The V.34 Dial Backup modem is described in a separate manual listed inside the front cover of this document.

#### VF Plug-in Card

Domestic models of the V.F 28.2/33.6 modem used only in a switched network do not require a VF plug-in. For domestic models in a private line application, the VF card is factory-installed for private line circuitry. In this application, the VF card is attached to the modem base card via connectors **XA1J1**, **XA1J2**, **XA1J3** and **XA1J4** ([Figure 2-1](#)). The VF plug-in has no option jumpers. For international models, a country-specific VF plug-in card is factory-installed and configured on each modem base card. [Table 1-2](#) lists country code part numbers for the VF card.

#### DTE Interface Plug-in Card

In addition to the built-in DTE interface, one of two unique DTE plug-in interface cards may be factory-installed on the modem base card via connectors **XA2J1**, **XA2J2**, **XA2J3**, and **XA2J4** ([Figure 2-1](#)). Note that these DTE interface plug-ins, listed below, have no option jumpers:

- GDC P/N 060P016-001: ITU-T V.35 DTE interface (ITU-T V.24/V.28/V.35/ISO 2593)
- GDC P/N 060P017-001: EIA/TIA-530-A DTE interface (ITU-T V.10/V.11/V.24/ISO 2110 Amendment 1)

#### 4-Port Adapter and Plug-in Card

The V.34 4-Port Modem comes equipped from the factory with a plug-in card at connectors **XA2J1**, **XA2J2**, **XA2J3**, and **XA2J4**. and an external 4-port adapter that attaches to the card through a shelf/enclosure DTE connector ([Figure 2-1](#)).

- GDC P/N 060P022-001: 4-Port External Adapter (Cannot be ordered separately from modem)
- GDC P/N 060P023-001: 4-Port Plug-in Card (Cannot be ordered separately from modem)

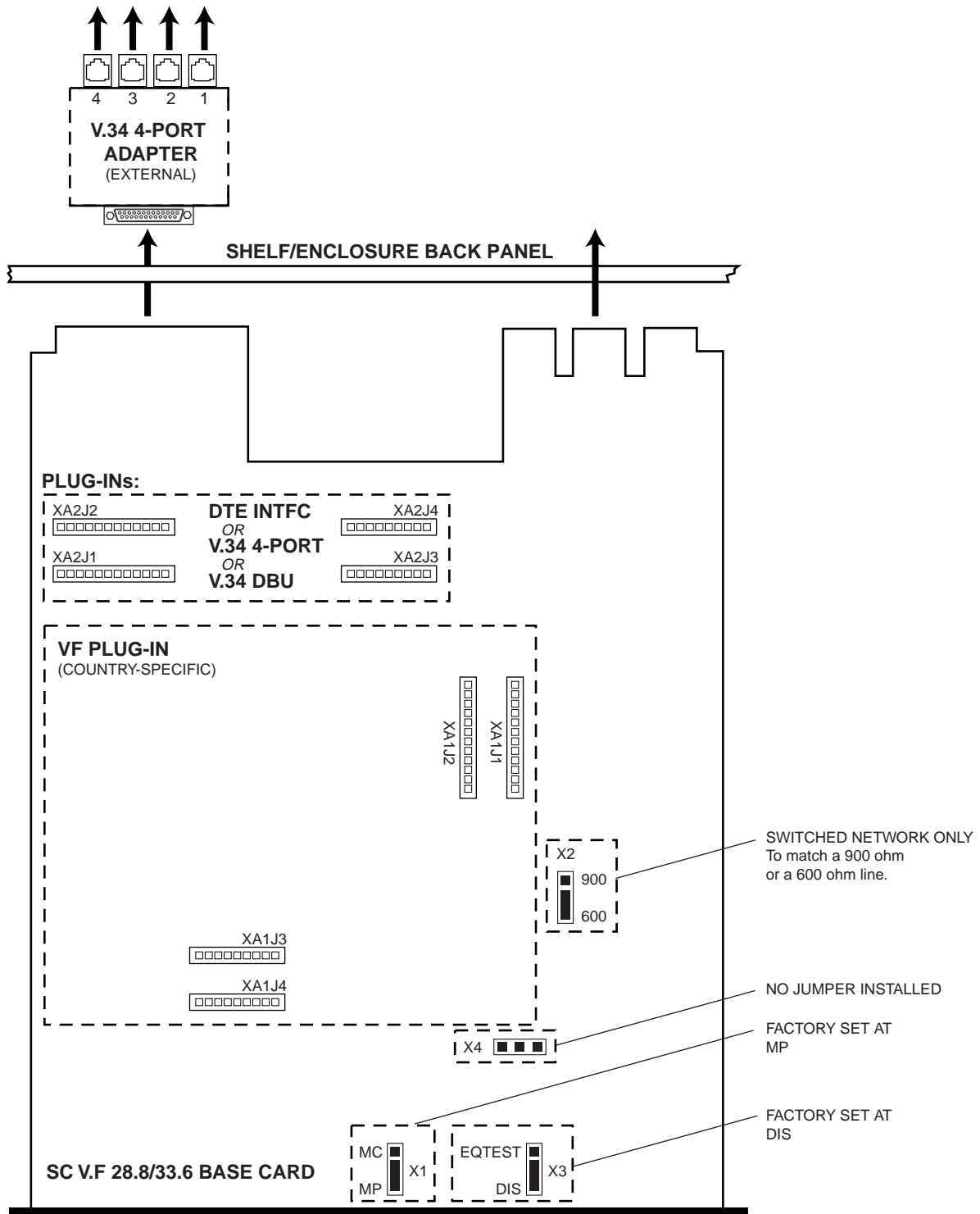

Figure 2-1 Modem Card Layout

**Note** *Figure 2-1* shows the location of various V.34 modem card components. Not all models of the V.34 modem are equipped with all components shown. For example, a V.34 DBU modem won't have a 4-Port plug-in.

## Installation Procedures

The V.F 28.8/33.6 is intended for installation in a SpectraComm/UAS Shelf or Enclosure. For additional information on a specific shelf or enclosure, refer to its accompanying documentation.



- a. *Be sure to install shelves and power supplies as described in the SpectraComm/UAS Shelf manual. Failure to do so may result in overheating and subsequent power supply shut-down.*
- b. *A shielded cable is required to comply with FCC Class B and EN 55022 Class B EMI requirements.*

### Installation Guidelines

- Locate the shelf or enclosure in a ventilated area where the ambient temperature does not exceed 122 degrees F (50 degrees C).
- Do not install the unit directly above equipment that generates a large amount of heat (such as power supplies).
- Before installing a high speed modem on an asynchronous port, confirm the highest speed supported by the DTE. Some asynchronous PC ports are restricted to 9600 bps or 19.200 bps operations. Refer to your computer documentation to determine if your PC is equipped with the hardware that supports up to 115,200 bps and compatible communication software.
- Before selecting high speed operations, review the limitations of your computer' operating system. The use of multi-tasking or Windows may place restrictions on asynchronous port performance.

### Modem Installation

1. Pull down the ejector tab, insert the modem into its shelf slot with the GDC logo on top, then slide it in until it makes contact.
2. Push up the ejector tab and firmly push the modem in until it seats in the shelf rear connectors. Refer to the connection information in this chapter to select the proper cables/adapters for connecting the unit to your network environment.

### Verifying Operation

1. The front panel display will flash **8.8.8.8.**, indicating a proper connection to the power supply. The display will then display **gdc**, indicating the Self Test is in progress. If **8.8.8.8.** does not flash, reset the modem or check that the modem and power supply are connected properly and are functional.
2. When the Self Test is complete, the display will appear blank except for a green dot near the **ND** label. This indicates the Power-On cycle is complete.
3. Verify that the switched network telephone line is connected properly by using a telephone to place a voice call.
4. If you are using a computer as your DTE, run your communications software and configure it for terminal emulation. If you are using an intelligent communications software package, it may be necessary to configure it for interactive mode. Refer to Chapter 3 for further details.
5. If you are using a terminal as your DTE, at the DTE, type **AT** and then press **Enter**. The modem should respond with an **OK** message. If not, check the DTE for proper configuration and check the DTE interface cable for a proper connection.

### Cable Connections

The shelf/enclosure rear panel provides upper and lower external interface connectors for V.F 28.8/33.6 communication and business equipment connections. These connections and associated adapters are shown in [Figure 2-2](#) and described in the following paragraphs. Additional cable connections for 4-Port operation are illustrated in [Chapter 3: V.34 4-Port Operation](#).

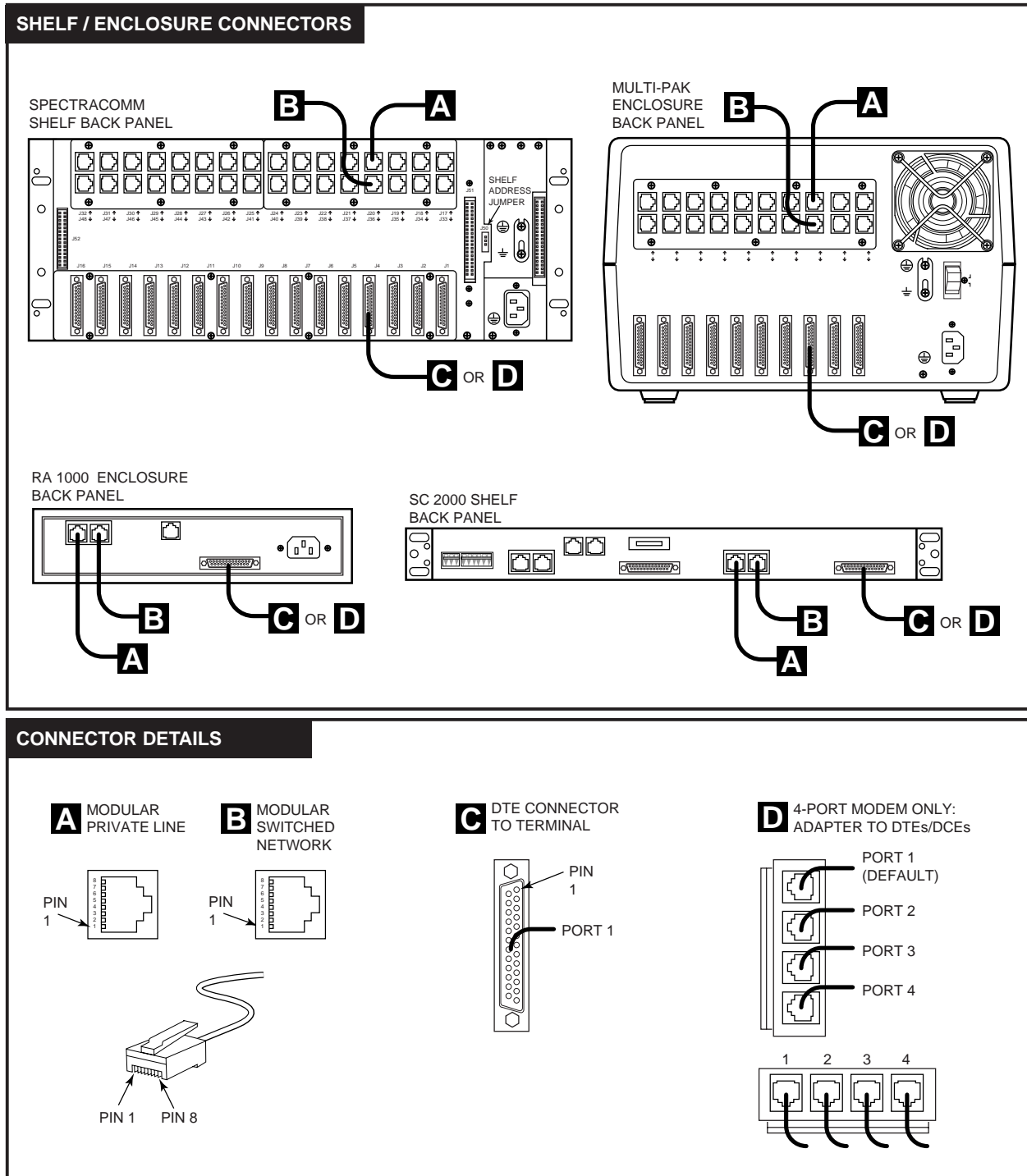

**Figure 2-2** Modem and Shelf/Enclosure Connections

## Communication Cables and Pinouts

Communication cables require modular-to-modular plugs. Comparing the wire color at both cable plugs determines if the cable is straight-thru or crossover. When colors are arranged in the same order at both ends, cable is straight-thru; if wires are crossed at one end, cable is crossover type. Refer to [Figure 2-2](#) and [Table 2-1](#).

If the Zone 1 connector panel has 8-position modular jacks, you may use a standard 6-position modular plug for a permissive connection. For a programmable connection, you must use an 8-position modular plug. SpectraComm/UAS shelves come with various configurations for private line and switched network connections. Refer to [Figure 2-2](#) and [Table 2-2](#).

**Table 2-1** Cables for Communication Lines

Shelf/Enclosure Connector	Cable Description	Part Number
Private (See Location A in <a href="#">Figure 2-2</a> )	Private network cable, with 8-pin to 8-pin unkeyed modular plugs	024H207-XXX
	Private 4-wire cable, with 8-pin keyed modular plugs	830-028-XXX
Switched (See Location B in <a href="#">Figure 2-2</a> )	Switched network permissive connection cable, with 6-pin modular plugs	830-027-XXX
	Switched network programmable connection cable	830-028-XXX

**Table 2-2** Modular Plug Pinouts

Switched Network Pinouts		Private Line Pinouts		
Pin Number	Network (SN)	Pin Number	Four-wire	Two-wire
1	no connection	1	R1	R1
2	no connection	2	T1	T1
3	no connection	3	no connection	no connection
4	R	4	no connection	no connection
5	T	5	no connection	no connection
6	no connection	6	no connection	no connection
7	PR	7	T	nc
8	PC	8	R	nc

## Business Equipment (DTE) Connectors and Pinouts

DTE cables and adapters connect to the modem's shelf/enclosure DB-25 connectors as shown in [Figure 2-2](#) and [Table 2-3](#). DTE pinouts for each interface is provided below:

- [Table 2-4](#) lists ITU-T V.35/V.24/V.28/ISO 2593 interface pinouts.
- [Table 2-5](#) lists EIA/TIA-530-A, ITU-T V.10/V.11/V.24/ISO 2110 interface pinouts.
- [Table 2-6](#) lists EIA/TIA-232-F, ITU-T V.24/V.28/ISO 2110 interface pinouts.
- [Table 2-7](#) lists EIA/TIA-561 interface pinouts.  
[Table 2-8](#) and [Table 2-9](#) list EIA/TIA-561 interface pinouts customized to V.34 4-Port operation.

**Table 2-3** Cables for DTE Connections

Shelf/ Enclosure Connector	Cable/Adapter Description	Part Number	Pinouts
DTE Port 1  (See Location C in <a href="#">Figure 2-2</a> )	Cable, TIA/EIA-232-F, DB25 male to DB25 male, S/T	028H502-XXX	<a href="#">Table 2-6</a>
	Extender Cable, TIA/EIA-232-F, male to female, S/T	028H506-XXX	<a href="#">Table 2-6</a>
	Cable, TIA/EIA-232-F, male to female, S/T	028H511-XXX	<a href="#">Table 2-6</a>
	Cable, EIA/TIA-530-A DB-25 male to DB-25 male, S/T	027H525-XXX	<a href="#">Table 2-5</a>
	Cable, ITU-T (ISO 2593) V.35, 34-pin male to male, S/T	027H516-XXX	<a href="#">Table 2-4</a>
	Adapter Cable, ITU-T V.35 (ISO 2593) DB-25 male to ITU to V.35 female	027H572-001	<a href="#">Table 2-4</a>
	Adapter Cable, TIA/EIA-232-F 25-pin male to ITU-T V.35 (34-pin female)	027H572-001	<a href="#">Table 2-6</a>
DTE Port 1, 2, 3, or 4 (4-Port Modem)  (See Location D in <a href="#">Figure 2-2</a> )	Cable, EIA-561, RJ45 to RJ45, S/T unkeyed	830-128-807	<a href="#">Table 2-8</a>
	Cable, EIA-561, RJ45 to RJ45 crossover 3-wire, unkeyed	021H104-XXX	<a href="#">Table 2-9</a>
	Adapter, EIA-561, RJ45 female to DB-25 male	029H210-001	-
	Adapter, EIA-561, RJ45 female to DB9 female	029H211-001	-

**Note** With the TIA/EIA-232-F (ITU-T V.24/V.28/ISO 2110) DTE interface, use standard EIA/TIA-232-F cables.

**Note** When selecting cables for use with the V.28.8/33.6 modem at high data rates, pay particular attention to the cable length and capacitance. Refer to the recommendations discussed later in this chapter: [Special Considerations for High Data Rates](#).

**Table 2-4** ITU-T V.35/V.24/V.28/ISO 2593 Interface Pinouts

Pin	232-F	V.24	Name	Direction	Function
B	7	102	SIG GND		Signal ground
C	4	105	RTS	To DCE	Request to send
D	5	106	CTS	From DCE	Clear to send
E	6	107	DSR	From DCE	Data set ready
F	8	109	CO/DCD	From DCE	Receive line signal detect
H	20	108.1	-	To DCE	Connect Data Set to Line
H	20	108.2	DTR	To DCE	Data terminal ready
NN	25	142	TME	From DCE	Test mode
L	18	141	ALE	To DCE	Analog Loopback enable
P	2	103	SD-A	To DCE	Transmitted data
R	3	104	RD-A	From DCE	Received data
S	14	103	SD-B	To DCE	Transmitted data
T	16	104	RD-B	From DCE	Received data
U	24	113	TT-A	To DCE	Terminal timing
V	17	115	RT-A	From DCE	Receive timing
W	11	113	TT-B	To DCE	Terminal timing
X	9	115	RT-B	From DCE	Receive timing
Y	15	114	ST-A	From DCE	Transmit timing
AA/a	12	114	ST-B	From DCE	Transmit timing
N	21	140	RLE	To DCE	Remote Digital Loopback enable
J	22	125	RI	From DCE	Ring Indicator
-	23	112	CI	From DCE	Speed Indicator

**Table 2-5** EIA/TIA-530-A (ITU-T V.10/V.11/V.24/ISO 2110) Interface Pinouts

Pin	232-F	V.24	Name	Direction	Function
2	BA-A	103-A	SD	To DCE	Transmitted Data
3	BB-A	104-A	RD	From DCE	Received Data
4	CA-A	105-A	RTS	To DCE	Request to Send
5	CB-A	106-A	CTS	From DCE	Clear to Send
6	CC	107	DSR	From DCE	Data Set Ready
7	AB	102-A	SIG GND		Signal Ground
8	CF-A	109-A	CO/DCD	From DCE	Data Channel Receive Line Signal Detect
9	DD-B	115-B	RC	From DCE	Received Clock
10	CF-B	109-B	CO/DCD	From DCE	Data Channel Receive Line Signal Detect
11	DA-B	113-B	TC	To DCE	Transmit Clock DTE Source
12	DB-B	114-B	SC	From DCE	Transmit Clock DCE Source
13	CB-B	106-B	CTS	From DCE	Clear to Send
14	BA-B	103-B	SD	To DCE	Transmitted Data
15	DB-A	114-A	SC	From DCE	Transmit Clock DCE Source
16	BB-B	104-B	RD	From DCE	Received Data
17	DD-A	115-A	RC	From DCE	Received Clock
18	LL	141	ALE	To DCE	Local Loopback
19	CA-B	105-B	RTS	To DCE	Request to Send
20	CD	108.1		To DCE	Connect Data Set to Line
20	CD	108.2	DTR	To DCE	Data Terminal Ready
21	RL	140	RLE	To DCE	Remote Digital loopback
22	CE	125	RI	From DCE	Ring Indicator
23	CI	112	TC	From DCE	Speed Indicator
24	DA-A	113-A	TC	To DCE	Transmit Clock DTE Source
25	TM	142	TME	From DCE	Test Mode Indicator



**Table 2-6** EIA/TIA-232-F (ITU-T V.24/V.28/ISO 2110) Interface Pinouts

Pin	232-F	V.24	Name	Direction	Function
2	BA	103	SD	To DCE	Transmitted Data
3	BB	104	RD	From DCE	Received Data
4	CA	105	RTS	To DCE	Request to Send
5	CB	106	CTS	From DCE	Clear to Send
6	CC	107	DSR	From DCE	Data Set Ready
7	AB	102	SIG GND	-	Signal Ground
8	CF	109	CO/DCD	From DCE	Data Channel Receive Line Signal Detect
15	DB	114	SC	From DCE	Transmit Clock DCE Source
17	DD	115	RC	From DCE	Received Clock
18	LL	141	ALE	To DCE	Local Loopback
20	CD	108/1		To DCE	Connect Data Set to Line
21	2.5	140	RLE	To DCE	Remote Digital Loopback
22	CE	125	RI	From DCE	Ring Indicator
23	CI	112	TC	From DCE	Speed Indicator
24	DA	113	TC	To DCE	Transmit Clock DTE Source
25	TM	142	TME	From DCE	Test Mode Indicator

### V.34 4-Port Modem DTE Pinouts

The DTE pinouts for the V.34 4-Port modem's EIA/TIA interface are provided below. [Table 2-7](#) describes the pinouts at each of the four ports of the the modem's external 4-Port adapter. [Table 2-8](#) describes the pinouts for the GDC straight-thru cable (RJ45M-RJ45M unkeyed). [Table 2-9](#) describes the pinouts for the GDC crossover cable (RJ45M-RJ45M unkeyed). If you are connecting the 4-port modem to a DCE, use the pinouts for the crossover cable.

**Note** For detailed connection, configuration and operating procedures for the V.34 4-Port Modem, refer to Chapter 3: [V.34 4-Port Operation](#).

**Table 2-7** V.34 4-Port Pinouts (GDC External Adapter P/N 060P022-001)

Pin	Signal	EIA/TIA-561 Description	Function	Direction
1	RI	Ring Indicator	-	-
	NOTE: At the DTE interface, the V.34 4-Port modem does not support Pin 1.			
2	RLSD	Received Line Signal Detector	Control	From DCE
3	DTR	DTE Ready	Control	To DCE
4	SGND	Signal Ground	Control	From DCE
5	RXD	Received Data	Data	From DCE
6	TXD	Transmitted Data	Data	To DCE
7	CTS	Clear to Send	Control	From DCE
8	RTS	Request to Send	Control	To DCE

**Table 2-8** Straight-Thru Cable Pinouts (GDC Cable P/N 830-128-807)

RJ45 Pin	Signal	Description	Function	Direction
2	RLSD	Received Line Signal Detector	Control	From DCE
3	DTR	DTE Ready	Control	To DCE
4	SGND	Signal Ground	Control	From DCE
5	RXD	Received Data	Data	From DCE
6	TXD	Transmitted Data	Data	To DCE
7	CTS	Clear to Send	Control	From DCE
8	RTS	Request to Send	Control	To DCE

**Table 2-9** Crossover Cable Pinouts (GDC P/N 021H104-XXX)

Pin	Signal	Direction	Signal	RJ45 Unkeyed Pin
4	SGND	From DCE	SGND	4
5	RXD	From DCE	TXD	6
6	TXD	To DCE	RXD	5

## Special Considerations for High Data Rates

Because of the high data rates possible with the V.F 28.8/33.6, the type and length of the DTE cable are important factors in ensuring data integrity. The modem's higher data rates require the use of shielded DTE cables. Further, the cable's capacitance and resistance, which vary with its length, must be evaluated to ensure that it can support the chosen data rate over the required distance.

### Capacitance and Cable Length

Cable capacitance is specified in two categories: conductor-to-conductor (C-C) and conductor-to-shield (C-S). Each of those capacitance values is expressed in PicoFarads per foot (pF/ft). To calculate a cable's total capacitance, add C-C to C-S and multiply the sum by the cable's length in feet. The following table shows the greatest total capacitance tolerated for each range of data rates, using an example calculation.

Example Calculation	Data Rates (kbps)	Total Capacitance (pF)
Example: A 10-foot cable with a C-C capacitance of 12.5 pF/ft and a C-S capacitance of 22.0 pF/ft.  Total capacitance = [(C-C) + (C-S)] * 10 = (12.5 + 22.0) * 10 = 34.5 * 10 = 345 pF	0.0 - 20.0	2400
	20.0 - 30.0	1200
	30.0 - 60.0	900
	60.0 - 100.0	450
	100.0 - 128.0	200

### Resistance and Cable Length

A DTE cable for use with the V.F 28.8/33.6 modem must have total resistance of 20 ohms or less. To calculate a cable's resistance, multiply its specified resistance value (in ohms per 1000 feet) by its length (in feet). The following table shows the greatest lengths that can be used at differing data rates for two GDC DTE cables: P/N 028H511-XXX (DB25 male-to-female) and P/N 028H502-XXX (DB25 male-to-male), where XXX designates the desired length in feet.

Example Calculation	Data Rate (kbps)	028H511-XXX				028H502-XXX			
		-050	-025	-010	-005	-050	-025	-010	-005
Example: A 10-foot cable with a resistance of 24 ohms/1000 ft.  Total Resistance = (24/1000) * 10 = 0.024 * 10 = 0.24 ohms	0.0 - 20.0	X				X			
	20.0 - 30.0		X				X		
	30.0 - 60.0		X				X		
	60.0 - 100.0			X				X	
	100.0 - 128.0				X				X



# Chapter 3: Operation

---

## Operation Overview

This chapter describes how to operate and configure the V.F 28.8/33.6 modem by using the front panel and through commands that control modem functions.

### Front Panel Controls and Indicators

The front panel provides LED indicators, a 4-character status display and five pushbuttons for monitoring or controlling modem functions. [Table 3-1](#) and the paragraphs that follow describes these controls and indicators. Front panel procedures follow the table.

### Modem Control Commands

The user can command modem control functions in three ways:

- AT commands sent to the modem from a terminal, PC, or other asynchronous DTE.
- ITU-T V.25 *bis* commands sent to the modem from a terminal, PC, or other DTE.
- Simple Network Management Protocol (SNMP) commands sent to the modem through a SpectraComm Manager (SCM) card.

This chapter provides detailed descriptions of these command functions. Refer as needed to additional information provided in separate sections of this manual:

- *Chapter 4: [AT Command Set Operation](#)* describes each AT command in detail, including the modem's configurable characteristics and functions that are controlled by the commands.
- *Chapter 5: [V.25 bis Commands](#)* describes the V.25 *bis* command set.

---

**Note** *Using a MIB browser, an SNMP network manager can also configure and control the modem through it's MIB objects. Refer to the GDC website at <http://www.gdc.com> to download the SpectraComm V.4 28.8/33.6 MIBs and the associated MIB tables.*

---

## The V.F 28.8/33.6 Front Panel

**Table 3-1** Front Panel Indicators/Controls

Front Panel	LED	Definition	Description	
	TXD	Send Data (Transmitted Data)	ON indicates a SPACE condition in the transmitted data. OFF indicates a MARK condition.	
	RXD	Received Data	ON indicates a SPACE condition in the received data. OFF indicates a MARK condition.	
	RTS	Request to Send	ON indicates the DTE has turned On DTE interface pin 4 (or RTS is On), indicating that the DTE is requesting the modem for data transmission. OFF indicates Pin 4 is Off.	
	CTS	Clear to Send	ON indicates the modem has turned On DTE interface pin 5 (or CTS is On), indicating it is ready to transmit data. OFF indicates the modem has turned Off pin 5, indicating it is not ready to transmit data.	
	DCD	Data Carrier Detect	ON indicates the modem has turned On DTE interface pin 8 (or DCD is On), indicating it is receiving data. OFF indicates the modem has turned Off pin 8, indicating it is not receiving data.	
	GD	Good Data	ON indicates the modem is receiving an acceptable carrier level and is equalized. OFF indicates the modem is not receiving an acceptable carrier level or is not equalized.	
	DTR	Data Terminal Ready	ON indicates the DTE has turned On DTE interface pin 20 (or DTR is On), indicating it is ready for data communications. OFF indicates the DTE has turned Off pin 20, indicating it is not ready for data communications.	
	OH	Off-Hook	ON indicates the modem is in the off-hook state. OFF indicates the modem is in the on-hook state. FLASHING indicates the modem is handshaking with a remote modem.	
	TM	Test Mode	ON indicates the modem is in a test mode. OFF indicates the modem is not in a test mode.	
	ALM	Alarm	Not Used	
		Control Keys (5)		Used for some configuration and testing without connecting a terminal. Refer to following paragraphs for details.
		Display Screen		A 4-character screen that displays the status of the modem.

## Front Panel Control Keys

### ADV Key

Advances the display to the next configuration selection.

Profiles include:

- **FAC0** to **FAC3**:Factory (fixed) profile **0** to factory profile **3**.
- **USr0** to **USr3**:User profile **0** to user profile **3**.

Command sets include:

- **At-C** Enable the AT command set.
- **OFFC** Disable all command sets.
- **25AC** Enable the V.25 bis asynchronous command set.
- **25bC** Enable the V.25 bis Binary Synchronous Communications (BSC or BISYNC) command set.
- **25HC** Enable the V.25 bis HDLC synchronous command set.

### ST Key

- Starts End-to-End Self-Test. (Use **LL**, **RL**, or **DL** to stop the test.)
- Can be used after **LL** for ITU-T V.54 Loop 3 with Self-Test.
- Can be used after **RL** for ITU-T V.54 Loop 2 with Self-Test.

### LL Key

- Starts/stops ITU-T V.54 Loop 3 (Local Loop or ANALOOP)
- Can be used before **ST** for ITU-T V.54 Loop 3 with Self-Test (Local Loop Self-Test or ANALOOP Self-Test)

### RL Key

- Starts/stops ITU-T V.54 Loop 2 (Remote Digital Loopback).
- Can be used before **ST** for ITU-T V.54 Loop 2 with Self-Test (Remote Digital Loopback Self-Test)

### DL Key

- Starts/stops ITU-T V.54 Loop 2 (Digital Loopback)

### SEL Key

- In config. mode:Selects the displayed profile as the new configuration.
- In idle mode:Displays DTE speed for two seconds.
- In data mode:Displays DCE speed for two seconds.
- To switch between talk mode and data mode, press **SEL** three times.

## Front Panel Procedures

The front panel displays status information, allows you to configure some aspects of the modem operation, described below. It also allows diagnostic functions which are described in Chapter 6.

### Status Operations



While the modem is in data mode or idle mode, it flashes decimal point four (on the top of the screen) to indicate power on.



While the modem is in idle mode, press SEL to display the DTE (terminal) speed for two seconds. The example illustrates the display for the last AT connect speed (the t on top indicates that the modem is displaying the terminal speed).

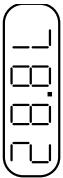

While the modem is in data mode, press SEL to display the DCE speed (the line or VF speed) for two seconds. The example illustrates the display for 28.8 kbps (the L on top indicates that the modem is displaying the line speed).

If the DCE speed changes while the modem is in data mode, the modem displays the new speed for two seconds.

### Configuration Operations

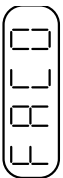

The modem must be in idle to enter configuration mode and select a profile or command set. To enter configuration mode, press SEL then press ADV (within two seconds). The modem displays the last profile selected from the front panel. The example illustrates the display for factory (fixed) profile 0

To scroll through the profile and command selections, press ADV. Profiles include FAC0 through FAC3 and USr0 through USr3. Command sets include At-C and OFFC, and 25AC, 25bC and 25HC. Refer to [Table 3-1](#) for details.

To select and make active the displayed profile or command set, press SEL. The modem displays the new configuration when you select a profile.

To abort configuration mode press LL, RL, or DL.

### Talk/Data Switch Operations



The V.F 28.8 allows you to switch between talk mode and data mode so that you can answer or disconnect calls manually.

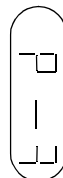

To switch between talk mode and data mode press SEL three times, pausing about one second each time. The modem displays the DTE or DCE speed, followed by the talk/data prompt (t-d). It then switches modes and returns to the idle display.



## Call Control Commands

Call control involves call initiation, completing a connection, call answering, and disconnecting a call. The following paragraphs describe the procedures required for each type of call control.

### Call Initiation

The V.F 28.8 modem can be commanded to initiate a call in any of three ways:

- Manually, using a telephone number supplied at the time the call is initiated
- Manually, using a telephone number stored previously in one of the 10 memory cells provided for that purpose
- Automatically in response to an Off-to-On transition of the DTR interface circuit, using a telephone number stored previously in memory cell 0

**Table 3-2** Common Call Control Commands

Command	This will...	Remember...
AT	get the modem's attention, telling it that a command is to follow.	this command must always precede any command line, except A/.
AT D	get the modem to dial the specified telephone number that follows.	your number can contain up to 30 digits.
P (following D command)	tell the modem to pulse dial.	you can use dial digits 0 through 9 for pulse dialing.
T (following D command)	tell the modem to tone dial.	you can use dial digits 0-9 and symbols A, B, C, D, #, * for tone dialing.
W (as part of dial command)	indicate to the modem that it must wait for a dial tone before dialing the number that follows.	you will use this command when you have to dial 9 to obtain an outside line.
; (as part of dial command)	cause the modem to return to the command mode after it has dialed the number, rather than immediately entering data mode.	this will serve to separate a command string containing more than 30 characters (so as not to overflow the buffer).
Sn (following D command)	instructs the modem to dial a previously stored number.	you can store 10 telephone numbers (n = 0 - 9) up to 30 digits each.
R (as last character in dial command)	cause the modem to establish a call in answer mode when calling an originate-only modem.	the R command must be the last character in the dial string before you enter a carriage return.
AT A	force the modem to answer incoming call.	the modem will not wait for a ring; no matter what is specified in the S0 register (see S-Registers in Chapter 4). This command is used for manually answering a call.
AT H	force the modem to hang up.	if you are in data mode, you must first enter command mode before using this command.

### Manual Call Initiation

The following example illustrates manual call initiation with a telephone number supplied at the time of the call. At the terminal or computer keyboard, type: **AT DP 9W8095551234 (Enter)** where: T

<b>AT</b>	AT command prefix, instructs modem to pay attention to the characters that follow
<b>D</b>	dial command, instructs modem to dial
<b>P</b>	dial modifier, instructs modem to use pulse dialing
<b>9</b>	instructs modem to dial 9 (to reach an outside line)
<b>W</b>	dial modifier, instructs modem to wait for a dial tone before continuing
<b>8095551234</b>	number modem is to dial - it will ignore parentheses, spaces, and hyphens
<b>Enter</b>	pressing Enter or Return key sends command line to the modem

*Note* Refer to the description of the Dial (Dn) command provided in Chapter 4 for functions of all dial modifier characters (such as **P** and **W** in this example).

### Manual Call Initiation with a Stored Number

The following examples illustrate how to store a telephone number in one of the modem's memory cells and how to initiate a manual call using a stored number. To store a telephone number type: **AT &Z3=(809) 555-1234 (Enter)** where:

<b>AT</b>	AT command prefix, instructs modem to pay attention to the characters that follow
<b>&amp;Z3=8095551234</b>	instructs modem to store the telephone number in non-volatile memory cell 3
<b>Enter</b>	pressing Enter or Return key sends command line to the modem

To manually initiate a call using a stored telephone number, type: **AT DT S3 (Enter)** where:

<b>AT</b>	AT command prefix, instructs modem to pay attention to the characters that follow
<b>D</b>	dial command, instructs modem to dial
<b>T</b>	dial modifier, instructs modem to use tone dialing
<b>S3</b>	dial modifier, instructs modem to dial the number stored in memory cell 3
<b>(Enter)</b>	pressing Enter or Return key sends command line to the modem

*Note* Refer to the description of the Dial (Dn) command provided in Chapter 4 for functions of all dial modifier characters (such as **T** and **S** in this example).

## Automatic Call Initiation in Response to DTR

The **AT** commands **%Z1** and **%Z3** both instruct the modem to observe the state of the Data Terminal Ready (DTR) interface. This function always uses the telephone number stored in memory cell 0.

When **%Z1** is used, the modem will dial automatically only when it detects a transition on the DTR lead. When **%Z3** is used, the modem will dial automatically whenever it is not connected to a remote modem and the DTR lead is On. In this instance, the **%Z3** command causes the modem to perform automatic redial for recovery of a broken connection without requiring intervention by the DTE.

## Completing a Connection

Once you have issued a dial command, the front panel should display **DIALING**. If the connection is successful, a **CONNECT** result code will appear, indicating a connection to the remote end. The result codes appear on your DTE screen when you issue a command. Every command should typically be followed with an **Enter** keypress. This will cause the answering equipment to send a prompt. If the **Enter** key is not pressed, you may be disconnected.

The front panel **CTS** and **DCD** indicators will remain on while the V.F 28.8/33.6 modem is connected to the remote end. The **TXD** indicator will flash while the modem is sending data and the **RXD** indicator will flash while it is receiving data from the remote end.

---

*Note* See Chapter 4 for a list of standard and extended result codes.

---

## Call Answering

### Automatic Call Answering

When enabled for automatic call answering, the modem uses built-in ring-detection circuitry to independently respond to incoming calls and switch to data mode. The value stored in **S-Register 0** determines whether auto-answer is enabled. The default value is  $n = 1$  (auto-answer enabled on the first ring). The value of  $n$  is programmable in AT modes of operation.

If the value is greater than 0, the modem will count ring signals on the line and display a **RING** message for each ring it counts. Once the ring count equals or exceeds the value of **S0**, the modem will go off hook and begin the handshaking procedure.

---

*Note* For more information on the S-Registers, including **S-Register 0**, see Chapter 4.

---

### Manual Call Answering

Manual Call Answering may be preferred when both voice and data calls are received on the same line. To prevent the modem from auto-answering any calls, store the value **0** in **S-Register 0**. You can manually answer a data call from either the keyboard or the modem's front panel.

To answer from the keyboard, enter the command **AT A (Enter)** upon receiving ring. To answer from the front panel, press the front panel **SEL** key three times (this acts as the talk/data switch). Either action will cause the modem to go off-hook and begin the handshaking sequence.

## Disconnecting a Call

There are several ways to disconnect a call:

- The **H** command disconnects the modem from the VF line. When using the modem in the asynchronous mode, first type the escape sequence. **ESCAPE** is a programmable character string, default **+++**). When the modem returns an **OK** to the DTE, type **AT H (Enter)** to terminate the connection.
- Loss of DTR - an irreversible data mode disconnect sequence occurs if circuit 108.2 (DTR) turns Off for more than 50 milliseconds when the modem is in data mode. The modem can be optioned for circuit 108.2 forced On (terminal dial mode) so that a DTE cannot cause a disconnect to occur using circuit 108.2.
- Character abort - when this feature is enabled, any character sent from the DTE to the modem at the originate end during dialing or the handshake sequence will abort the call. **%Kn** controls this function in all command modes.
- Loss of carrier - the modem will go on-hook if the handshake sequence is not completed successfully within the time specified in **S-Register 7**. This abort timer is programmable for 1 to 30 seconds via the **S7=x** command. The originating and answering modem both have the abort timer active during the handshake sequence.
- No answer or busy - when an originating call is not answered within the time specified by **S-Register 7**, the modem will disconnect. If it detects a busy tone, the modem will disconnect immediately and display the **BUSY** message.
- Long space disconnect - if optioned to do so via the **Yn** command, the V.F 28.8 will initiate and respond to the long space disconnect procedure. When initiating disconnect for any reason except loss of carrier, the modem will transmit four seconds of continuous spacing (receive data clamped to a mark), and then go on-hook. A modem receiving 1.6 seconds of continuous space on the VF line will go on-hook. This feature is only functional at speeds of 2400 bps and lower.

## Password Security Overview

The SpectraComm V.F 28.8 modem supports up to three types of Security:

- SteadFast Security (*uses a cell password stored in the modem*)
- On-line Password Security (*uses cell passwords stored in the modem*)
- RADIUS Security (*uses RADIUS passwords stored in the RADIUS server*)

---

**Note** *RADIUS Security requires a GDC Dual V.34 modem or a V.F 28.8 modem optioned for RADIUS at the factory. In addition, a GDC SCM card with RADIUS installed and enabled, and a customer-supplied RADIUS server are also required. Refer to the SpectraComm Manager Operation Manual, Appendix B, to determine if your system is RADIUS ready.*

---

### Enabling Security in the Modem

The `%Sn` command allows you to configure the modem for a single type of security or for a valid combination of security types: SteadFast Security, On-line Security, both SteadFast and Online Security, or RADIUS Security. Depending on your preferences, you will need to configure the modem properly to enable the desired options for each type of security. Consult the special considerations below and refer to [Table 3-3](#) for the `%Sn` commands which enable security and set security combinations.

#### Security Combinations - Special Considerations

- If both the SteadFast Security and Online Security are enabled, the SteadFast Security cell password must be confirmed first during the handshake sequence. Then, the Online Security sequence can proceed with the cell password prompt and any configured Callback functions.
- If both SteadFast Security and Online Security are enabled, SteadFast Security callback is blocked. In this situation, only Online Security with Callback can take place.
- If RADIUS Security is enabled, cell passwords stored in the modem will allow access if the modem does not receive password authentication from the RADIUS server after 60 seconds. If this is a desirable security arrangement for your network, ensure that cell passwords stored in the modem are created with all uppercase characters.
- With RADIUS Security, if cell passwords are not stored in the modem, the modem will disconnect a caller when the RADIUS server(s) or the SCM do not respond to the modem after 120 seconds. For more information, refer to the SCM Card Operation Manual, Appendix B.
- When creating a SteadFast Security cell password, both modem handshake modes must be V.34 (**&H1**), V.32 bis (**&H3**) or V.32 (**&H5**).

#### Cell Passwords

The `%Pn` command allows you to configure or disable cell passwords in the modem. With SteadFast Security, only one identical cell password is stored in memory cell `0` of both the answering and the originating modem. With Online Security, the user can store up to ten cell passwords in the answering modem in memory cells `0` through `9`.

With RADIUS Security, the user can store cell passwords in the modem in order to make Online Security available under special conditions. This use of cell passwords provides a lesser degree of security but allows access if the SCM fails or all RADIUS servers fail. Refer to the SCM Operation Manual, Appendix B for detailed information on RADIUS Security Special Conditions.

---

**Note** *The factory default command **&F** does not affect the **%P**, **%F** or **&Z** commands. Refer to [AT Command Set Operation](#) for a detailed description of all modem commands.*

---

### Configuring Modem Response

With SteadFast and/or Online Security enabled the user can configure the modem(s) for a Pass-thru Response or a Callback Response. Refer to [Table 3-3](#) for the commands which control these security options. If the %S2 command is used, it is strongly recommended that the escape character sequence be disabled by entering S2=128 and then pressing **Enter**.

**Table 3-3** SpectraComm V.F 28.8 Security Selection and Configuration

Security	Option	Originate Modem	Answer Modem
Passwords Disabled	-	%S0 ATDT[ <i>phone number</i> ]	%S0
SteadFast Security Only	Pass-thru	%S1 %P0=[ <i>SteadFast password</i> ] ATDT[ <i>phone number</i> ]	%S1 %P0=[ <i>SteadFast password</i> ]
	Mandatory Callback with number in Cell 1	%S1 %P0=[ <i>SteadFast password</i> ] ATDT[ <i>phone number</i> ] \ 1	%S4 %P0=[ <i>SteadFast password</i> ] &Z1=[ <i>callback phone number</i> ]
	Callback with number in Cell 1 Not Mandatory	%S1 %P0=[ <i>SteadFast password</i> ] ATDT[ <i>phone number</i> ] \ 1	%S1 %P0=[ <i>SteadFast password</i> ] &Z1=[ <i>callback phone number</i> ]
Online Security Only	Pass-thru	%S0 ATDT[ <i>phone number</i> ]	%S2 %P1=[ <i>Online password</i> ] %F1=0
	Mandatory Callback with number in Cell 1 (,C)	%S0 ATDT[ <i>phone number</i> ]	%S6 %P1=[ <i>Online password</i> ] %F1=2 &Z1=[ <i>callback phone number</i> ]
	Callback with password in Cell 1 (,C) Not Mandatory	%S0 ATDT[ <i>phone number</i> ]	%S2 %P1=[ <i>Online password</i> ] %F1=2 &Z1=[ <i>callback phone number</i> ]
Online Security and SteadFast Security	No Callback	%S1 %P0=[ <i>SteadFast password</i> ] ATDT[ <i>phone number</i> ]	%S3 %P0=[ <i>SteadFast password</i> ] %P1=[ <i>Online password</i> ]
Online Security and SteadFast Security	Callback with password in Cell 1 (,C) Not Mandatory	%S1 %P0=[ <i>SteadFast password</i> ] ATDT[ <i>phone number</i> ]	%S3 %P0=[ <i>SteadFast password</i> ] %F1=2 &Z1=[ <i>callback phone number</i> ]
Online Security and SteadFast Security	Mandatory Callback	%S1 %P0=[ <i>SteadFast password</i> ] ATDT[ <i>phone number</i> ]	%S7 %P0=[ <i>SteadFast password</i> ] %P1=[ <i>Online password</i> ] %F1=2 &Z1=[ <i>callback phone number</i> ]
RADIUS Security	Cell passwords stored in the modem.	%S0 ATDT[ <i>phone number</i> ]	%S2 %P1=[ <i>Online password</i> ] %F1= 0
	No cell passwords stored in Cells 0 - 9. (Maximum security)	%S0 ATDT[ <i>phone number</i> ]	%S2 %P (Remove cell passwords in cells 0 - 9 )

## SteadFast Password Security

With SteadFast Security, the user enters the same cell password in both modems in the memory cell 0 (%P0=xxx, where xxx is the cell password). Both modems must be GDC modems optioned for SteadFast Security (%S1). The modem that initiates the call sends the cell password as part of its handshake sequence. The remote user does not have to type in any additional cell passwords.

---

**Note** When both SteadFast Security and Online Security are enabled, be aware that SteadFast Security authentication will take place first, during the handshake. In addition, SteadFast callback will be blocked. Callback can only occur if configured for Online Security.

---

### Steadfast Security with Pass-Thru

SteadFast Security with Pass-thru requires that both the originating and answering modems be GDC modems optioned for cell passwords with the %S1 command. When the remote caller initiates a call, the answer modem attempts to match the passwords stored in cell 0 of both modems during the handshake. With a match, the answer modem directly admits a caller using a valid cell password. If an invalid cell password is entered, the answering modem terminates the call.

### SteadFast Security with Callback

A remote user initiating a call can invoke the SteadFast Security callback feature by including the AT dial command modifier \n, where n represents a phone number cell in the answering modem. The dial command modifier, when combined with the valid SteadFast Security cell password, causes the modem to disconnect the incoming call and dial the number from the specified memory cell. The callback phone number must be saved in a phone number cell of the answering modem by means of the &Zn=nnn command. Up to ten phone numbers can be stored in memory cells 0 through 9 using the &Z command.

*Example:* To call a modem at 555-1212 and have it call back the phone number stored in cell 1, enter the following modem command:

```
ATD5551212\1
```

After handshaking and a short delay, the remote modem terminates the call, and places a new call, using the phone number stored in cell 1, back to the modem that initiated the process. If the dial command modifier had not been included, the SteadFast Security cell password would have resulted in a pass-thru connection.

### SteadFast Security with Mandatory Callback

The answering modem can be configured for SteadFast Security with a Mandatory Callback by using the %S4 command. The calling modem must be optioned for %S1 and a callback phone number must be saved in the answering modem by means of the &Zn=nnn command. To initiate a connection, the caller must include a valid callback cell number with the phone number that is dialed.

*Example:* **ATDT5551212\1**

If the callback cell number is not supplied with the phone number, the answering modem will disconnect the call.

---

**Note** Security callback telephone numbers should always include the Retry modifier [:n] to compensate for any delay in receiving the dial tone from the Central Office after the initial connection is terminated. Configure the modem to make at least three additional attempts to dial the number. If calls abort during handshake, try disabling character abort feature (%K1).

---



## Online Password Security

The modem provides ten memory cells for storing cell passwords for Online Security. The command for storing an online cell password is `%Pn=xxx`, where  $n$  is the password cell number (0 through 9) and  $xxx$  is the password. The cell password can be any string of up to ten characters. Do not use commas in the cell password. The comma is reserved to identify the callback response function.

### Online Security with Pass-thru

Online Security with Pass-thru requires that the answering modem be a GDC modem, and optioned for Online Security with the `%S2` command. When a caller initiates a call to an answer modem that has Online Security enabled, the modems handshake then the caller receives the prompt:

**ENTER PASSWORD**

The operator has 20 seconds to respond with a valid cell password. When a cell password is received, the modem compares it to the contents of all ten memory cells. With a match, the modem admits the call directly. When an invalid cell password is entered, the modem disconnects the call.

### Online Security with Callback

If the remote user initiating the call wants to use the Callback with Online Security, a callback phone number must have previously been saved in the answering modem by means of the `&Zn=nnn` command. Up to 10 phone numbers can be stored in cells 0 through 9 by means of the `&Z` command. You can view the stored phone numbers by using the `&V` command. Stored phone numbers are used by the callback function, which is described below.

Online Security with Callback requires that an online cell password be configured with a callback extension. A callback extension causes the answering modem to disconnect and then call back to the modem that placed the original call. Use the `%Fn=x` command to enable callback extension, where  $n$  is the online password cell number and  $x$  defines if a callback is allowed or how the password in that cell can be used for callback. The modem will use the phone number stored in the cell number to call back the originating modem, to ask user for call back phone number, or to deny any callback.

### Callback Extensions

A remote operator can attach one of two callback request extensions to the online cell password entry: `,R` (roving callback) or `,C` (cell callback).

With the roving callback extension (`,R`) the answering modem prompts the caller for a telephone number to use for the callback. Once the number is supplied, the answering modem disconnects the original call and places a return call using the number it has just been given. The cell password and its attached roving callback extension must have been stored in the answer modem with the appropriate password cell qualifier: `%Fn=1` or `%Fn=3`.

With the memory cell callback extension (`,C`) the answering modem prompts the caller for a phone number memory cell (0-9) in the answering modem. Once the cell number is supplied, the answering modem disconnects the original call and places a return call using the phone number stored in that memory cell. The cell password and its attached memory cell callback extension must have been stored in the answering modem with the proper password cell qualifier: `%Fn=2` or `%Fn=3`.

A cell password stored with cell qualifier `%Fn=0` will not accept any attached callback extension.



### Online Security with Callbacks

The following Online security sequences occur when a remote user uses a valid cell password to place a call to a modem that will use either a stored callback number or a roving callback number. If an invalid cell password is entered, the answering modem will directly terminate the call.

---

**Note** *If both SteadFast and Online Security are enabled, the SteadFast security sequence will occur first, during the handshake. Then, the Online Security sequence will occur, using the configured Callback Response.*

---

#### When a Stored Callback number is used:

1. The modems handshake, then the caller's screen displays the prompt:

**ENTER PASSWORD**

2. Within 20 seconds the caller has to respond with a valid cell password configured in the answering modem:

*password,C* [ENTER]

3. The caller's screen displays the prompt:

**ENTER CELL NUMBER**

4. The caller has to specify the memory cell number in the answering modem that is configured with the calling modem's number:

*cell #* [ENTER]

5. The caller's screen displays:

**NO CARRIER** (*indicates the disconnect*)

**RING** (*indicates the incoming call*)

**CONNECT** (*followed by the appropriate connect message, indicates the modems are in data mode*)

#### When using a Roving Callback number is used:

1. The modems handshake, then the caller's screen displays the prompt:

**ENTER PASSWORD**

2. Within 20 seconds the caller has to respond with a valid cell password configured in the answering modem:

*password,R* [ENTER]

3. The caller's screen displays the prompt:

**ENTER PHONE NUMBER**

4. The caller has to specify the phone number that the answering modem needs to dial to establish the callback:

*nnnnnnnn* [ENTER]

5. The caller's screen displays:

**NO CARRIER**(*indicates the disconnect*)

**RING** (*indicates the incoming call*)

**CONNECT**( *followed by the appropriate connect message, indicates the modems are in data mode*)

## RADIUS Security (Remote Authentication for Dial-In Users)

When optioned at the factory, the SpectraComm V. F 28.8 modem can support RADIUS (Remote Authentication for Dial-In User Service). RADIUS is an optional software feature for the SpectraComm Manager Card that allows a V.F 28.8 modem optioned for RADIUS to open a client service session for RADIUS security. The V.F 28.8 modem can be optioned for RADIUS Security at the time of sale, or at a later time through a factory upgrade.

When RADIUS is enabled in the modem and the SCM, the modem prompts the caller for a RADIUS user name and a RADIUS password. This information is passed to the secure RADIUS server via the SCM for authentication. Once authenticated by the RADIUS server, access to the network is then either granted or denied.

---

**Note** For detailed information on RADIUS including setup, configuration and operation procedures, refer to the SpectraComm Manager Card (SCM) Manual, Appendix B: SCM with RADIUS.

---

### Confirming RADIUS Capability

To confirm that a specific SpectraComm V.F 28.8 modem is capable of RADIUS Security, use the AT command **I4** and check the Product Code field. If the modem is RADIUS capable the screen will display the following Product option:

**Product Code: SEC**

Product code **SEC** indicates that the modem is capable of RADIUS Security. If other Product codes are displayed, such as **288**, your modem will not support RADIUS.

---

**Note** To upgrade your V.F 28.8 modem to RADIUS capability, ask your GDC Sales Representative for that modem's RADIUS Feature upgrade (GDC P/N 060U500-D04).

---

### Enabling RADIUS in the Modem

To enable RADIUS at the answering modem, type in the **%S2** command. Save the configuration by typing **AT &W** and then press **Enter**. This instructs the modem to perform a RADIUS Security sequence on every dial-in caller.

### Special Considerations

To achieve the highest level of RADIUS Security, perform the following additional steps:

- Remove all cell passwords from the modem using the **%P** command. This done, if it should happen that all RADIUS servers fail or if the SCM fails, Online Security will not be forced on and all dial-in access to the network will be denied until the servers are back online.
- Disable the capacity for Remote Configuration of the modem by using the **AT \*R1** command. Save this configuration by typing **AT &W** and then press **Enter**.

---

**Note** For more information on RADIUS Security, refer to the SpectraComm Manager Card Operation Manual, Appendix B.

---

## Operation Modes and AT Commands

There are two modes of communication between the V.F 28.8 modem and its DTE: command mode and data mode. When in data mode, the V.F 28.8 modem transmits and receives data over a telephone line to a modem and a DTE at another site. When in command mode, the modem can accept AT commands which determine how it will perform those essential functions.

### Data Mode and Command Mode Overview

- To use AT commands requires a computer or terminal at the DTE port with an EIA/TIA-232-F, EIA/TIA-530-A or V.35 serial port to enable communication between the DTE and the modem. For V.34 4-Port modems, a connection to a DTE or DCE via the EIA/TIA-561 interface is required. If a computer is the DTE, it will also require a communications software package. Any error correction or data compression software used by the computer must support flow control.
- When powered up, the modem is in command mode. It enters data mode when you command it to go on-line to another modem by dialing a switched network connection or initiating handshake for a private line connection. The modem can also enter data mode when it goes on-line in response to a connection initiated by a remote modem.
- Command mode is always asynchronous; data mode can be either asynchronous or synchronous.
- The **AT &M** command can configure the modem for asynchronous operation in both modes, or for asynchronous operation in command mode and synchronous operation in data mode.
- Depending on its option settings, you can set the V.F 28.8/33.6 modem to enter command mode and wait for the next AT command by one of three methods:
  - Using AT &D1 command
  - Dropping DTR
  - Typing the Escape sequence (+++)

### Testing the Modem

Tests performed with the modem in asynchronous mode do not use error control. Consequently, by making the remote loop test during an error control connection, the error control mode is terminated and transmission errors caused by the transmission link can be detected. Refer to Chapter 6 for a description of basic diagnostics.

## AT Data Mode

The V.F 28.8 modem is in data mode while it has a telephone line connection to another modem or is in the process of establishing a connection. In Data Mode the modem transmits all the data it receives from the DTE over the phone line.

In data mode the modem can operate either asynchronously or synchronously, as specified by the &M command. A variety of data protocols are available for each type of operation. Some protocols provide error correction to improve reliability and/or data compression to increase throughput. The two types of data mode operation, and their protocols, are described at length in the following pages.

Each telephone line connection (whether switched network or private line) between two modems in data mode begins with a handshaking sequence. During that sequence the modems determine the VF (telephone line) speed, data protocol, and related parameters for the data link. Configuration determines the range of choices available to the modem in the negotiation process. Most configuration options in the V.F 28.8 modem act to limit the range over which a parameter can be negotiated, rather than making specific assignments.

The modem's DTE can cause it to enter data mode and initiate dialing (switched network) or handshaking (private line) by asserting the Data Terminal Ready (DTR) signal at the interface or by issuing an AT command to dial. Configuration determines whether or not the modem is controlled by DTR. The presence of a carrier from a remote modem will cause the V.F 28.8 modem to enter data mode and assert a Data Carrier Detect (DCD) signal to its DTE.

## AT Command Mode

In command mode the modem looks at everything you type on the DTE keyboard. When the modem detects a valid command, it will be executed. AT commands can cause the V.F 28.8 modem to answer a call, hang up or dial, change an S-Register value, or perform other command functions, as described later in this manual.

---

**Note** *Some AT commands can be issued from the modem's front panel. Refer to [Front Panel Control Keys](#) in this Chapter.*

---

### Command Syntax

An AT command takes the form of a single letter or a combination of a letter and a modifier character, often followed by one or more numeric characters. The modem interprets the AT command as a direction to set a configuration parameter or perform an action. The command (letter or letter and modifier) identifies the parameter or action, and the numeric value specifies (from a pre-established range of choices) how the parameter is to be set or how the action is to be performed. Some AT commands, such as those used to program telephone numbers, involve further modification through the use of an equal sign (=) followed by additional numeric characters.

You send AT commands to the modem individually or in a command string of up to 40 characters, not including spaces and line feed characters. Each command or command string begins with **AT** and ends with a carriage return. The letters **AT** stand for **AT**tention and signal the modem that a command(s) will follow. The AT prefix also permits the modem to determine the asynchronous data rate and parity settings of the local DTE. You can type either **AT** or **at**, but mixed-cases (such as **At** or **aT**) will not give predictable results.

Multiple commands in a string may be separated by space or line feed characters to improve readability, although they will be ignored by the modem. A carriage return character must be entered at the end of a command line to signal the modem to process the command string. Correct mistakes by using the **backspace**, or **CTRL-H** to delete characters to the left. The AT prefix cannot be deleted.

### Command Buffer

When the command line is sent to the modem, it is loaded into a command buffer with a capacity of 40 characters. The AT prefix, spaces, line feed characters, and carriage return are not loaded into the buffer, and so do not count as part of the 40-character limit. If a command line is more than 40 characters long, the modem will only act on commands that are contained in the first 40 characters.

The **A/** command instructs the modem to re-execute the command line currently in the buffer. It is to be sent to the modem as a command line that consists of only the **A/** command and a carriage return - no AT prefix. This is the only command line that does not begin with the AT prefix.

---

**Note** *AT Command Syntax Exceptions: The **A/** command does not require the AT command line prefix. The command for displaying basic AT command set help is simply **\$**. It can also be combined with any of the valid modifiers to display help for the extended AT command sets.*

---

## Configuration Profiles

A configuration profile consists of the set of AT commands the modem is given to establish its operating characteristics. The V. F 28.8 modem can store four factory-provided fixed profiles and four user defined profiles. By recalling and loading a stored profile you can completely reconfigure the modem without having to change individual options. The individual profiles in each of the two sets are identified as 0 - 3.

- The command to recall and load a fixed profile is **&F*n***.
- The command to recall and load a user defined profile is **Z*n***.
- The command to store a user defined profile is **&W*n***. When it receives the **&W*n*** command, the modem stores the configuration options in effect at that time as user defined profile *n*.

Each time its power is turned On the modem recalls and loads a user defined profile. You specify which of the four user defined profiles it will use for that purpose by means of the Power Up User Configuration Profile command, **&Y*n***. When the modem leaves the factory the initial default setting for **&Y*n*** is user defined profile 0. The factory default for user profile 0 is the same as fixed profile 0.

---

*Note* Refer to Chapter 4, AT Command Set Operation for description of the **&F*n***, **Z*n*** and **&W*n*** commands.

---

## Automatic DTE Speed and Parity Detection

The modem is shipped with the DTE interface set for 7 bits with parity at the last **AT** speed. This determines the modem's DTE speed when auto answering. In command mode the modem automatically detects the DTE's operating speed and asynchronous character parity (**ODD**, **EVEN**, **SPACE**, or **MARK/NONE** parity) when it receives the **AT** prefix from the DTE. The modem can automatically adapt to character length and parity of the incoming data at any of the following asynchronous bit rates:

128,000 bps	115,200 bps	112,000 bps	96,000 bps
76,800 bps	72,000 bps	64,000 bps	57,600 bps
56,000 bps	48,000 bps	38,400 bps	33,600 bps
32,000 bps	31,200 bps	28,800 bps	26,400 bps
24,000 bps	21,600 bps	19,200 bps	16,800 bps
14,400 bps	12,000 bps	9600 bps	7200 bps
4800 bps	2400 bps	1200 bps	300 bps

---

*Note* Configuration via the **&H** command determines modem modulation at a DTE speed of 1200 or 300 bps. At 1200 bps the modem can be configured to use either ITU-T V.22 or Bell 212A modulation. At 300 bps the modem can be configured to use either ITU-T V.21 or Bell 103 modulation.

---

## Remote Configuration Using the AT Commands

Remote Configuration allows you to use a local V.F 28.8 modem to connect to a remote V.F 28.8 modem and view or change the remote modem's current user configuration profile. The DTE interface on the remote modem is disabled during a Remote Configuration session to prevent the remote DTE from inadvertently terminating the session.

Before you initiate a Remote Configuration session, you must ensure the following:

- Modems must either both be in switched network mode or both be in private line mode.
- The local modem must be in AT command mode (%V0 or **PRS AT** command). The remote modem will be forced into AT command mode when the connection is established.
- The local modem must be in an asynchronous error correcting mode. The remote modem will be forced into asynchronous mode when the connection is established.
- Both modems must have the same remote configuration security password (**\*Pn** command). If the remote modem does not have a remote configuration security password, you may configure one during the Remote Configuration session.
- The remote modem's handshake mode must be V.34 (**&H0**, **&H1**, or **&P0** command), V.32 *bis* (**&H2**, **&H3**, or **&P1** command), or V.32 (**&H4**, **&H5**, or **&P2** command).
- If you intend to save changes, you must enable remote configuration write access via the **\*R1** command at the remote modem before initiating the session. The correct setting for the **\*Rn** command is actually **\*R0**.
- With Remote Configuration, responses and echoes from the remote to the local modem are enabled, even when the remote modem is optioned for Quiet Mode and Echo Off.
- The following commands are invalid during a Remote Configuration session and will cause an error response:
  - **A** (answer call)
  - **Dn** (dial)
  - **Hn** (hookswitch)
  - **On** (on-line)
  - **&Tn** (test mode), except **&T4** and **&T5**

### Remote Configuration Procedure (AT Commands)

1. To initiate a Remote Configuration session, enter **\*W1** at the local modem. (In switched network mode, you must place the call to the remote modem.)
2. Upon connection, the local modem displays one of the following:  
**OK REMOTE CONFIG SESSION VIEW** (when write access is disabled)  
**OK REMOTE CONFIG SESSION EDIT** (with write access is enabled)
3. If write access is enabled, edit the remote modem's current user configuration profile in the same way you would the local modem. These changes become part of the configuration profile, but do not take effect at this point.
4. Once you have made your changes, terminate the session according to the following options:
  - To terminate the session without saving or using the new profile, enter **\*X0**.
  - To terminate the session and put the new profile into use temporarily, enter **\*X1**. The modem will use the new configuration only until it is reset or power is cycled.
  - To terminate the session and save the new configuration as a user defined profile that can be recalled and loaded at a later time, use the **&Wn** command and then **\*X1** to terminate the session and put the new configuration into use.

### Remote Configuration Using an MMS Controller

Remote Configuration over a link between two V.F 28.8 modems can be performed with SNMP commands from an MMS controller, using the following procedure. The following MMS commands are invalid during a Remote Configuration session:

- Modem reset
- Modem in/out of service
- Make clear/busy
- Diagnostic tests
- Test results
- Remote configuration password
- all dialing operations except Terminate call
- Front panel inhibit/enable

### Remote Configuration Procedure (MMS Controller)

1. At the local site, select the MIB variable **Remote Configuration**, and enable MMS enumeration.
2. Perform normal dialing to establish connection between local and remote modem.
3. Send configuration changes to the remote modem.
4. Terminate the session according to the following options:
  - To save changes made during the session, terminate the session by setting the MIB variable **End Remote Configuration** at the remote modem to **Update**.
  - To end the session without saving changes, set the MIB variable to **No Update**.



## Asynchronous Operation

When you select Operating Mode 0 (**&M0**) the V.F 28.8 modem will operate asynchronously both while on-line (data mode - connected to the telephone line) and while off-line (Command Mode - disconnected from the telephone line).

The V.F 28.8 modem can employ error correction (reliable) protocols to ensure error-free delivery of asynchronous data sent between computers. The error control methods are based on grouping data into frames with checksums determined by the contents of each frame. The receiving modem checks the frames and sends acknowledgments to the transmitting modem. When it detects a faulty frame, the receiving modem requests a retransmission. Frame length varies according to the amount of data transmitted or the number of retransmissions requested from the DTE.

The modem can achieve DTE speeds greater than the maximum VF speed through the use of a data compression protocol. Two asynchronous compression protocols are available in the V.F 28.8: ITU-T V.42 *bis* and MNP Level 5. They attempt to increase throughput by compressing the information to be sent before actually sending it. The modem is thus able to transmit more data in a given period of time. Characteristics of the individual compression techniques are discussed below.

The V.F 28.8 supports the following asynchronous DTE speeds:

128,000 bps	115,200 bps	112,000 bps	96,000 bps
76,800 bps	72,000 bps	64,000 bps	57,600 bps
56,000 bps	48,000 bps	38,400 bps	33,600 bps
32,000 bps	31,200 bps	28,800 bps	26,400 bps
24,000 bps	21,600 bps	19,200 bps	16,800 bps
14,400 bps	12,000 bps	9600 bps	7200 bps
4800 bps	2400 bps	1200 bps	300 bps

The V.F 28.8 supports the following VF data speeds:

33,600 bps	31,200 bps	28,800 bps	26,400 bps
24,000 bps	21,600 bps	19,200 bps	16,800 bps
14,400 bps	12,000 bps	9600 bps	7200 bps
4800 bps	2400 bps	1200 bps	300 bps

## Error Correcting Modes

The `\N` command selects one of five error correcting modes which use bidirectional data buffering and flow control. This permits the modem to operate with different data rates set at the computer serial port and the modem port. For each mode, the modem interprets `\N` in combination with the `%C` command to determine what data compression protocol (if any) is available. Each mode is described below. [Table 3-4](#) list the command combinations that set the various mode characteristics.

---

**Note** *V.42 (LAPM)/MNP Auto-reliable Mode or V.42 (LAPM)/MNP Reliable Mode will probably be the configuration used most often. Experimentation along with careful study of the command language will indicate what works best for your application.*

---

### MNP Operation Overview

When you enable the modem for MNP operation, you configure it to be compatible with a range of MNP levels: MNP Levels 2 - 5 and MNP Levels 2 - 4. The range of levels or service classes or levels allow its use with older equipment and recent equipment. The `\N` command determines whether the modem can use MNP Levels 2 - 4. (The V.F 28.8 modem is compatible with MNP Levels 2 - 4.) Once MNP Levels 2 - 4 are enabled, the `&C` command determines whether Level 5 is available.

When attempting an MNP reliable connection, modems will negotiate the connection for the highest common MNP service level permitted by their configuration. The following list briefly describes characteristics of the MNP levels that provide only correction.

Level 2	is an asynchronous full-duplex protocol. Data frames and acknowledgments can be transmitted simultaneously. The maximum frame size is 256 bytes.
Level 3	is a synchronous full-duplex protocol. The modem sends the call setup asynchronously and switches to synchronous mode when sending the data. The maximum frame size is 256 bytes.
Level 4	provides synchronous framing with adaptive frame lengths. The frame length is automatically adjusted according to the line quality (based on number of retransmissions). The frame header in Level 4 is shorter than in Level 3, which results in a slight improvement in throughput - about 20% improvement in comparison to nominal data rate.

---

**Note** *Asynchronous DTE must be used for all levels of MNP error control.*

---

### MNP Reliable Mode Error Correction (Levels 2 - 4)

In MNP Reliable Mode (**\N2**), the V.F 28.8 will only connect with another modem that has an error correction system capable of establishing an MNP reliable link. When the connection is made, the modem immediately attempts to establish an MNP reliable link. If the attempt fails, the V.F 28.8 disconnects. A failed attempt might be caused by:

- a. Remote modem does not support an MNP reliable link.
- b. Remote modem is an MNP modem, but is not in the proper mode.
- c. Telephone connection is so poor and noisy that even an MNP reliable link connection would not be able to assure dependable communications.

You may not want to use certain software error-correcting protocols with an MNP reliable link because redundant error checking will reduce the link's file transfer efficiency. Some file transfer protocols are designed for use with hardware error-correcting modems, such as **IMODEM** and **YMODEM-G**. (ZMODEM has been shown to perform within a few percentage points of the other protocols.)

When using MNP reliable mode, it is important that you know the remote system's capabilities and status. If you call a non-MNP or V.42 modem while in MNP reliable mode, your connection will fail. If you cannot obtain the appropriate information about the remote system, you should probably use V.42 (LAPM)/MNP auto-reliable mode.

### MNP Reliable Mode with Data Compression (Level 5)

MNP Level 5 provides error correction and data compression for improved throughput. Level 5 error correction provides synchronous framing with adaptive frame lengths. The sending modem performs data compression by detecting redundant data and re-coding it into fewer bits. The receiving modem decompresses the data before passing it to the receiving computer.

MNP Level 5 throughput is very sensitive to the data structure being transmitted. ASCII text files will produce the greatest throughput gains, about 70% improvement in comparison to nominal VF data rate. Files with **.EXE**, **.COM** and **.ARC** extensions may show as little as 60% of the throughput benefits accorded ASCII files.

### V.42 (LAPM) Reliable Mode Error Correction

The V.42 (LAPM) reliable error correction mode (**\N4**) is very similar to the MNP reliable mode (**\N2**), except that, during the handshake, it first looks for the LAPM character. The modem transmits a Link Access Protocol (LAPM) character as part of the handshake when it attempts to negotiate a V.42 link. The V.42 protocol provides error correction compliant with the ITU-T V.42 error correction scheme and supports the ITU-T V.42 bis data compression algorithm.

In addition to its own error correction technique, the V.42 specification includes MNP-2 through MNP-5 capability. It is backward compatible with the current GDC MNP-5 FEM. Since the V.42 protocol also includes the MNP protocols, if the V.42 (LAPM) connection attempt fails, the modem will drop the call.

Due to increased complexities during the handshaking procedures, the V.42 (LAPM) reliable mode is recommended for use only with other V.42 modems when data integrity is critical. All V.42/MNP options use AT commands only for set up.

### V.42 *bis* Data Compression

V.42 *bis* data compression is only possible when the modem has established a V.42 (LAPM) error correcting connection. V.42 *bis* compression generally gives improved throughput results versus MNP 5 compression, particularly when transferring previously compressed files. V.42 *bis* only compresses files where it can improve performance. MNP 5 attempts to compress every file, even if doing so can't improve the throughput and results in degraded performance.

Many "bulletin boards" use a file compressor, such as **PKZip**, to store and send files. V.42 *bis* provides greater efficiency than MNP 5 for such files. V.42 *bis* advantages are only available using the V.42 (LAPM)/MNP reliable (\N5), V.42 (LAPM) reliable (\N4), or V.42 (LAPM)/MNP auto-reliable (\N3) operating modes.

### V.42 (LAPM)/MNP Auto-reliable Mode

When the type and status of the remote modem is not known, the V.F 28.8 can use V.42 (LAPM)/MNP Auto-reliable Mode (\N3) to make an initial connection and then look at the remote's data stream for incoming V.42 or MNP characters. If the appropriate characters are detected, the V.F 28.8 establishes a reliable link. If the modem cannot establish a reliable link, it falls back to Wire Mode or direct V.14 mode (see [Non-Error Correcting Modes](#), below).

The AT command \C*n* determines what mode the modem will fall back to and how it will handle data it receives before its mode is established. The handshake sequence that occurs when a V.F 28.8 modem auto-answers a call in V.42 (LAPM)/MNP Auto-reliable Mode can have one of three outcomes:

- success, resulting in a negotiated error correcting link
- failure, resulting in a fallback to the mode specified by \C*n*
- reception of two successive fallback characters, if enabled by \C*n*, resulting in an immediate fallback to the specified mode. The %A*n* command defines the modem's fallback character.

Use of a fallback character permits the 4-second handshake sequence to be cut short when there is no chance it will succeed.

### V.42/MNP Reliable Mode

The V.42/MNP reliable mode (\N5) is very similar in performance to the V.42/MNP auto-reliable mode (\N3). The difference is that failure to establish an error correcting link will cause the modem to disconnect rather than to fall back to a non-error correcting mode.

### MNP-10 Mode for Cellular Phones

This mode (-**M*n***) enables or disables cellular phone mode. **M*n*** enables or disables automatic power levels, and @**M*n*** sets the initial transmit power level for a cellular phone. When using cellular phones, \***H*n*** establishes the negotiation speed of two MNP-10 modems.

## Non-Error Correcting Modes

The V.F 28.8 modem also employs the following non-error correcting modes:

- wire mode
- direct V.14 asynchronous mode
- V.13 mode

Like the MNP and V.42 protocols, these modes are configured using the `\N` command.

### Wire Mode

Wire mode (`\NO`) is used to communicate with standard, non-error correcting modems. The V.F 28.8 will fall back to wire mode if it fails in an attempt to negotiate an auto-reliable link with the remote modem. Error correction is not active in wire mode.

Wire mode provides data buffering so that the modem's DTE and VF interfaces can operate at different speeds. For example, the local DTE can exchange data with the local modem at 19,200 bps while the modem communicates at 2400 bps with the remote modem. To do this, however, the local terminal emulation software must allow its autobaud feature to be turned off and allow flow control.

### Direct V.14 Asynchronous Mode

In direct V.14 mode (`\N1`) there is no error correction, data compression, or data buffering. The modem's DTE data rate and VF line speed must be set to the same value. If, for example, the link between the V.F 28.8 and the remote modem operates at 9600 bps, then the local DTE must exchange data with the V.F 28.8 at 9600 bps.

### V.13 Mode

V.13 mode (`\N6`) is a simulated controlled carrier mode designed for polling applications. It uses the ITU-T V.13 RTS/DCD signaling method to control the remote modem's DCD lead via the local modem's RTS lead. It can be used for both synchronous and asynchronous data. The RTS/DCD signaling can be configured for either bi-directional or unidirectional control by the `&E` command.

## Flow Control

Flow control and buffering compensate for the rate differences of error correction and data compression. In combination with internal data buffering, flow control permits portions of a data link to operate at different speeds. For example, the rate of transfer between the local DTE and modem can be greater than the VF line speed negotiated between the local and remote modems, while the modem-to-DTE transfer rate at the remote site can differ from both.

The V.28.8 modems' buffers compensate for such differences to a large degree, but flow control comes into play when data traffic approaches the limits of buffer capacity. Flow control meters incoming data and can stop it from coming in when there is not enough room available in the modem's internal buffer. Without flow control, data will be lost if the modem port and the VF line interface don't operate at the same bps rate.

Flow control can be achieved either by software or by hardware. Software flow control involves control characters inserted within the transmitted data. Hardware flow control is achieved by altering the voltage level of various signal lines at the interface between the computer's serial port and the modem. The V.F 28.8 supports three forms of hardware flow control: one (described below) that is compatible with asynchronous operation, and two that are only for use with synchronous data compression.

### Software Flow Control

Software flow control uses the **XON** (Control-Q) and the **XOFF** (Control-S) characters. The characters are inserted in the transferred data. When using **XON/XOFF** software flow control, make sure that only the desired element in the system responds to the flow control characters. If you are using **XON/XOFF** to control the local serial port, you may not want the flow control characters to be passed along to the remote modem with the data.

The **\G** command is used to determine whether the V.F 28.8 processes the flow control characters and passes them to the remote modem along with the data, or simply processes them and deletes them from the data stream.

### Hardware Flow Control

Hardware flow control can be either unidirectional or bi-directional. Exactly how you set the flow control commands depends on your application. Bi-directional hardware flow control is recommended if your application demands both file uploads and downloads and the transfer protocol does not support any form of XON/XOFF.

Hardware flow control for asynchronous operation usually uses the signals RTS (request to send) and CTS (clear to send). Study the commands **\G** and **\Q** in the Extended AT Command Set in Chapter 4 for further information on this topic. In MNP Reliable Mode or V.42 Mode the protocol itself controls data flow on the modem port. Retransmissions due to a very noisy phone line may cause the buffer to fill, however, so the use of flow control on the serial port is still important.

[Table 3-4](#) lists the AT commands used to enable the different types of data compression and error correction.

**Table 3-4** Enabling Error Correction/Data Compression

To Enable	Use AT Commands
V.42 Auto Reliable	
V.42 <i>bis</i>	
MNP 2-5	
Wire	
\N3 and %C1	
V.42 (LAPM) and V.42 <i>bis</i> only	\N4 and %C1
V.42 only	\N4 and %C0
MNP Level 2-5 only	\N2 and %C1
MNP Level 2-4 only	\N2 and %C0
V.42, V.42 <i>bis</i> or MNP 2-5 only	\N5 and %C1
V.42 or MNP 2-4 only	\N5 and %C0
No data compression and no error correction	\N0 or \N1, and %C0
MNP-10	-Mn -M0 - disables MNP19 -M1 - enables MNP10 Auto Reliable mode (Recommended setting) -M2 - enable MNP10 reliable mode (will not fallback to V.42/V.42bis)
)Mn Cellular Phone Power Level Adjustment - enables or disables automatic power adjustment of the transmit power level to accommodate the signaling requirements of cellular telephone equipment	)M0 - disables transmit power level adjustment during MNP10 link negotiation. The )M0 command allows the transmitter adjustment if cellular operation is requested by the remote modem (recommended). )M1 - enables transmit power level adjustment during MNP10 link negotiation. Uses the @Mn value to establish initial cellular connection. After connection, the optimal power level is determined by the modem. Note: For both cellular and land based modems in both originate or answer modes, if )M1 is set, the transmit power level used for non-MNP10 or fax connections is the @Mn value. Also, the )M1 setting should not be used when *H2 is selected.
*Hn MNP Link Negotiation Speed - controls the connection speed for link negotiations before up-shift occurs between two MNP10 modems.	*H0 - link negotiations occurs at the highest supported speed. *H1 - link negotiations occurs at 1200 bps; used primarily for establishing cellular connections. *H2 - link negotiation occurs at 4800 bps primarily to negotiate an MNP10 connection on less-than-average quality telephone lines. Note: For both cellular and land based modems in both originate or answer modes, if )M1 is set, the transmit power level used for non-MNP10 or fax connections is the @Mn value
@Mn Initial Cellular Power Level Settings - sets the initial transmit power level for up-shift at connect until line conditions can be determined. Levels can be set from -10 dbm to -31 dbm.	@M0 - initial transmit power level of -26 dBm. @M1 - initial transmit power level of -30 dBm (Recommended setting) @M2 - @M10 - initial power level of -10 dBm @M11-@M31 - initial power level of -11 dBm to -31 dBm, respectively.
Dial Modifiers	J - perform MNP10 link negotiations at 1200 bps (this call only). See *H1 command. K - enable power level adjustment during MNP10 link negotiation (this call only). See )M1 command.

## Synchronous Operation

### Synchronous Operating Modes

The &Mn (Operating Mode) command selects between asynchronous and synchronous Data Mode operation. Its synchronous mode setting, &M1, supports asynchronous dialing with synchronous transmission. The \Mn command also selects the protocol that the modem will follow while it is in synchronous Data Mode. The V.F 28.8 modem can be configured for synchronous operation by selecting one of the above synchronous operating modes from the front panel.

### Asynchronous Dialing with Synchronous Transmission

The &M1 mode, Asynchronous Dialing with Synchronous Transmission, supports DTE that are capable of communicating synchronously or asynchronously over the same RS-232 port.

Your call is placed using the asynchronous command set. Once the call connection is established, the V.F 28.8 modem will automatically switch to synchronous operation.

The &M1 mode also permits you to use an asynchronous DTE to dial and then switch to a synchronous-only DTE once the call is connected. If the &D setting is other than &D0, the S25 register will determine the length of time permitted to switch DTE before the call is disconnected.

### Direct Dialing in Synchronous Mode

Direct dialing in synchronous data mode can be accomplished in either of two ways:

- DTR dialing, selected by %Zn
- V.25 bis commands

When DTR dialing is enabled (%Z1), the V.F 28.8 modem will automatically dial the previously stored number (stored using the &Zn=nnn command) when it detects an OFF to ON transition on DTR.

If you wish to save this profile, issue the &W command. The modem will then come up in this mode any time power is applied.

---

**Note** *Once DTR dialing has been selected, you may find that the modem goes off-hook and begins dialing the stored number the moment you connect your DTE. To prevent this, turn off your modem before you connect the DTE to the modem. When the connection is complete, turn the modem back on.*

---

The V.25 bis command set is described in detail in Chapter 5.

### Normal Synchronous Mode

The \M0 command selects the Synchronous Protocol for normal synchronous operation. The modem employs a constant carrier on the VF line. The DTE-to-VF speed relationship is direct, that is the two speeds must match. The following DTE data rates are available (\Tn command) when the modem operates in normal synchronous mode:

28,800 bps	26,400 bps	24,000 bps	21,600 bps	19,200 bps
16,800 bps	14,400 bps	12,000 bps	9600 bps	7200 bps
4800 bps	2400 bps	1200 bps		



## V.13 Synchronous Mode

The \M1 command selects the Synchronous V.13 Protocol. V.13 mode is a simulated controlled carrier mode designed for polling applications. It uses the ITU-T V.13 RTS/DCD signaling method to control the remote modem's DCD lead via the local modem's RTS lead.

The RTS/DCD signaling can be configured for either bi-directional or unidirectional control by the &E command. The following DTE data rates are available (\Tn command) when the modem operates in V.13 synchronous mode:

28,800 bps	26,400 bps	24,000 bps	21,600 bps	19,200 bps
16,800 bps	14,400 bps	12,000 bps	9600 bps	7200 bps
4800 bps	2400 bps	1200 bps		

## Synchronous Compression Mode

The \M2 command selects the Synchronous Compression Protocol. The modem can compress synchronous DTE data framed in HDLC/SDLC format, with a maximum frame length of 2048 bytes. Synchronous compression supports the following DTE data rates (\Tn command):

128,000 bps	115,200 bps	112,000 bps	96,000 bps	76,800s
72,000 bps	64,000 bps	57,600 bps	56,000 bps	48,000 bps
38,400 bps	32,000 bps	28,800 bps	26,400 bps	24,000 bps
21,600 bps	19,200 bps			

Two techniques for modem-to-DTE hardware flow control are available for use with synchronous compression. Both require that the modem be configured for internal timing (see below). Flow control for synchronous compression can be accomplished by:

- Clock Stopping (\Q5) in which the modem prevents buffer overflow by sharply reducing the frequency of the transmit clock signal it outputs to the DTE.
- Clock Throttling (\Q6) in which the modem prevents buffer overflow by varying the rate at which it outputs the transmit clock signal to the DTE

---

**Note** *Synchronous Compression is an optional feature that is not included in all V.F 28.8 modems. To check the presence of the feature in your modem, use AT command I5 to display a list of information concerning the modem. Sync Compression On/Off is included in that list.*

---

## Clock Selection

The synchronous format relies on transmit and receive clocks to maintain character timing, so it does not need start and stop bits for each character. The V.F 28.8 modem can be configured to use one of the following three clock sources to transmit synchronous data:

- Internal (&X0) - transmit clock generated by the V.F 28.8 modem.
- External (&X1) - transmit clock signal generated by the DTE is passed to the modem with data.
- Receiver (&X2) - transmit clock derived by the local modem from the data it is receiving from the remote modem (also called wrap timing).

The preferred clock source varies for different computer systems. Consult your computer's manual for its particular specifications. Regardless of which transmit clock source it is using, the V.F 28.8 modem always outputs its transmit clock signal to the DTE on pin 15 of the EIA interface. Pin 17 always provides the receive clock signal derived from the incoming data. When the DTE provides external transmit clock it does so on Pin 24.

---

**Note** *The receive clock is always controlled by the remote modem that sends the data being received. It is not recommended to have the local and remote modems both configured to derive transmit clock from received data.*

---

## Switched Network Operation

To establish a connection with another modem, you use the auto-dial facility of the V.F 28.8 modem.

### Telephone Lines

If the V.F 28.8 modem is connected to a business telephone system, such as a multi-line key system or PBX, there can be noise generated by the system that can affect telephone quality. For optimal throughput, connect the V.F 28.8 modem to a single switched line that only it uses.

Many telephone companies offer "call waiting" service that alerts you to another call coming in while you are on the line. Call waiting service can interfere with modem data calls or even disconnect the modem. In error correction mode the modem will correct data interference caused by call-waiting, but doing so degrades throughput. If you have call-waiting, you should disable it while you are on the line to prevent loss of throughput. In some areas, for example, you can disable call waiting by dialing 70# or \*70 on your pushbutton telephone. Verify the call-waiting numbers with your local telephone company.

The following are examples of commands to send to the modem to disable call waiting for the duration of a call (the telephone number 555-1234 is provided for example only)  
For Touch-Tone dialing:

```
ATDT*70W5551234
```

For Both Pulse and Touch-Tone Dialing:

```
ATD1170W5551234)
```

---

**Note** *After the \*70 or 1170 number is dialed, your PSTN should respond with dial tone. Call-waiting will be disabled for the duration of that call. Once the call is disconnected, call-waiting will be enabled again. Verify the numbers and their effects with your local telephone company.*

---

Another method is to set your modem to S10=150. This setting lets your modem ignore a brief cut-off caused by call-waiting, and prevents it from hanging up while on-line.

## V.34 4-Port Operation

The V.34 4-Port model of the V.F 28.8/33.6 modem allows an authorized user to communicate with and configure compatible equipment connected to its DTE ports. Refer to [SpectraComm V.F 28.8/33.6 Modem Models](#) to determine if your modem is capable of 4-Port operation.

### Typical 4-Port Connectivity

The V.34 4-Port modem provides a EIA-561 interface at its external 4-port adapter. Cables from these ports connect to **Control**, **Terminal**, or **Console** ports on compatible DTEs/DCEs. When the DTE happens to be a SCM card, the connection port can be the SCM's **WAN**, **DBU WAN**, or Front Panel **CTRL** port.

[Table 3-5](#) and [Figure 3-1](#) describe recommended cables for typical deployments of the V.34 4-Port modem via the EIA-561 interface. Refer to *Chapter 2, Installation -Cable Connections* for other interfaces.

### Security Requirements

Access to the 4-Port function is security protected by means of modem cell passwords or by RADIUS Authentication, if the modem was ordered with RADIUS. If Online Security or RADIUS Security is not enabled and operational, the 4-Port function will be disabled; only Port 1 (default) will be available to dial-in users. For detailed information on configuring the modem for any of these security methods, refer to [Password Security Overview](#) in this chapter.

### Communicating with GCD Product Cards

The V.34 4-Port modem allows dial-in users to select one of its four ports to connect to certain GDC product cards residing in various types of GDC shelves or enclosures ([Figure 3-1](#)). A dial-in user can select Ports **1** through **4** to connect to a SC 521A, a SC 800 T3, a SC 553, or a SCM card. Making cable connections to these product cards depends on the type of shelf/enclosure involved:

- GDC product cards residing in a SC 2000 shelf or a RA 1000 shelf will require a EIA-561 crossover cable from the shelf's rear panel **Terminal** port to one of the four DTE ports of the V.34 4-Port modem. Refer to [Table 3-5](#).
- GDC product cards residing in a SpectraComm/UAS shelf or Multi-Pak enclosure will require a EIA-561 crossover cable connects Front Panel **CTRL** port of an SCM in that shelf/enclosure to one of the DTE ports of the V.34 4-Port modem. Refer to [Table 3-5](#).

### Communicating with Other Customer Equipment

Through any one of the four ports of the V.34 4-Port modem, dial in users can connect with customer equipment such as a router, a Telco switch or an ATM console. An EIA-561 straight thru cable is required. Refer to [Figure 3-1](#) for typical deployments of the modem with these types of customer equipment. [Table 3-5](#) lists cable recommendations.

**Table 3-5** V.34 4-Port Cable Connections

<i>From <a href="#">Figure 3-1</a>:</i>	<b>EIA-561 Modem Cable Description</b>	<b>Destination</b>	<b>Part Number</b>
<i>Location A</i>	Customer-supplied cable	To Craft, CTRL or TERM port	Custom cable
<i>Location B</i>	EIA-561 RJ45 to RJ45 crossover 3-wire unkeyed	To shelf/enclosure TERM port	021H104-XXX
<i>Location C</i>	EIA-561 RJ45 to RJ45 crossover 3-wire unkeyed	To SCM WAN port	021H104-XXX
<i>Location D</i>	EIA-561 RJ45 to RJ45 straight-thru 8-wire unkeyed	To SCM DBU WAN port	830-128-807
<i>Location E</i>	EIA-561 RJ45 to RJ45 crossover 3-wire unkeyed	To SCM CTRL port	021H104-XXX

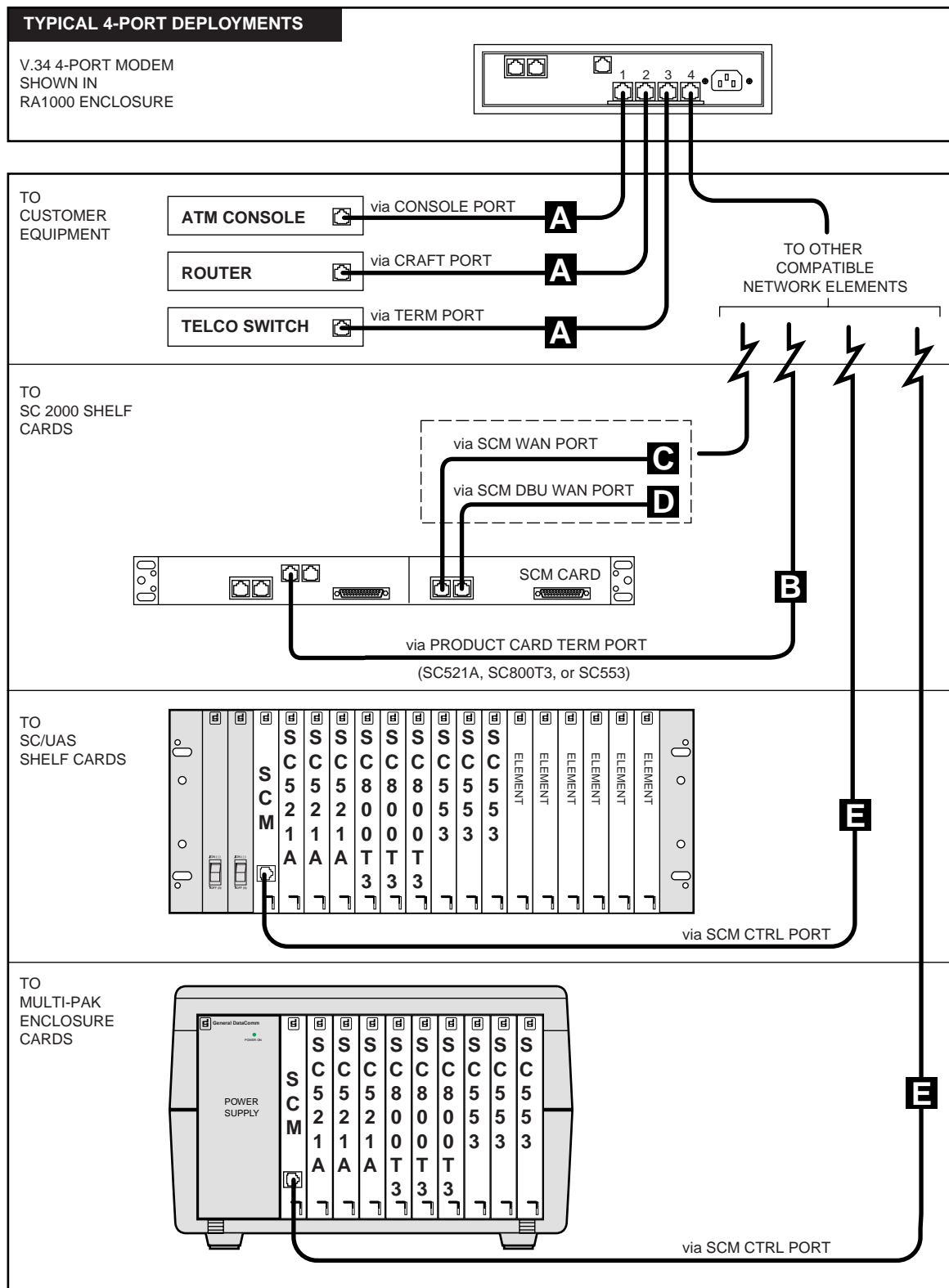

Figure 3-1 Typical Deployments of the V.34 4-Port Modem

### 4-Port Operation Guidelines

- Ensure that the proper cables/adapters have been used to connect the V.34 4-Port modem in your network. Refer to paragraphs on [Cable Connections](#) in *Chapter 2, Installation*.
- Online Security or (if so equipped) RADIUS Security must be enabled and operational in order for the user to make DTE port selections. Refer to [Password Security Overview](#) in this chapter.
- The following modem configurations are strongly recommended:
  - **ATE0** Local Echo Off
  - **ATQ1** Quiet Mode
  - **S2=128** Escape Code Characters Off
  - **%K1** Abort Character Off
- After setting the modem to the desired speed and character format, ensure that all devices that connect to the modem's 4-Port adapter use the same speed and character format.
- If you need to download new firmware to the modem through the DTE, remove the external 4-port adapter from the shelf/enclosure. Use the cable from the computer to make a direct connection to the shelf/enclosure DB25 connector. After download is complete, replace the modem's 4-port external adapter.

### Terminal Setup

[Figure 3-2](#) demonstrates two ways of connecting the modem to a computer terminal or other DTE device for the purpose of initially configuring the modem or for downloading new firmware.

- Example 1 shows how to make the connections from a computer terminal's serial port to **Port 1** of the modem's external 4-port adapter. This connection uses a GDC cable and cable adapter as detailed in [Table 3-6](#).
- Example 2 shows how to make the connection without the modem's external 4-port adapter attached. This connection uses a customer-supplied DB25M straight-thru serial cable from the modem's DTE port to a computer terminal's serial port. With the adapter temporarily removed, the modem's DTE port defaults to **Port 1**.

**Table 3-6**

Connector	Description	Part Number
A in <a href="#">Figure 3-2</a>	Cable Adapter, IBMPC RS-561 DB9F to RJ45	029H211-001
B in <a href="#">Figure 3-2</a>	Cable, EIA-561 RJ45 to RJ45 straight-thru 8-wire unkeyed	830-128-807
C in <a href="#">Figure 3-2</a>	Customer-supplied cable	-

**Note** The 4-Port modem can also be configured remotely across the switched network by using AT Commands, an MMS Controller, or SNMP commands from any GDC modem.

For more information, refer to sections in this chapter ([Remote Configuration Using the AT Commands](#) or [Remote Configuration Using an MMS Controller](#)). To configure and control the modem with a MIB browser, refer to the GDC website at <http://www.gdc.com> to download the SpectraComm V.4 28.8/33.6 MIBs and the associated MIB tables.

**Note** To configure the 4-Port modem through an SCM card in the same shelf, refer to the SCM documentation.

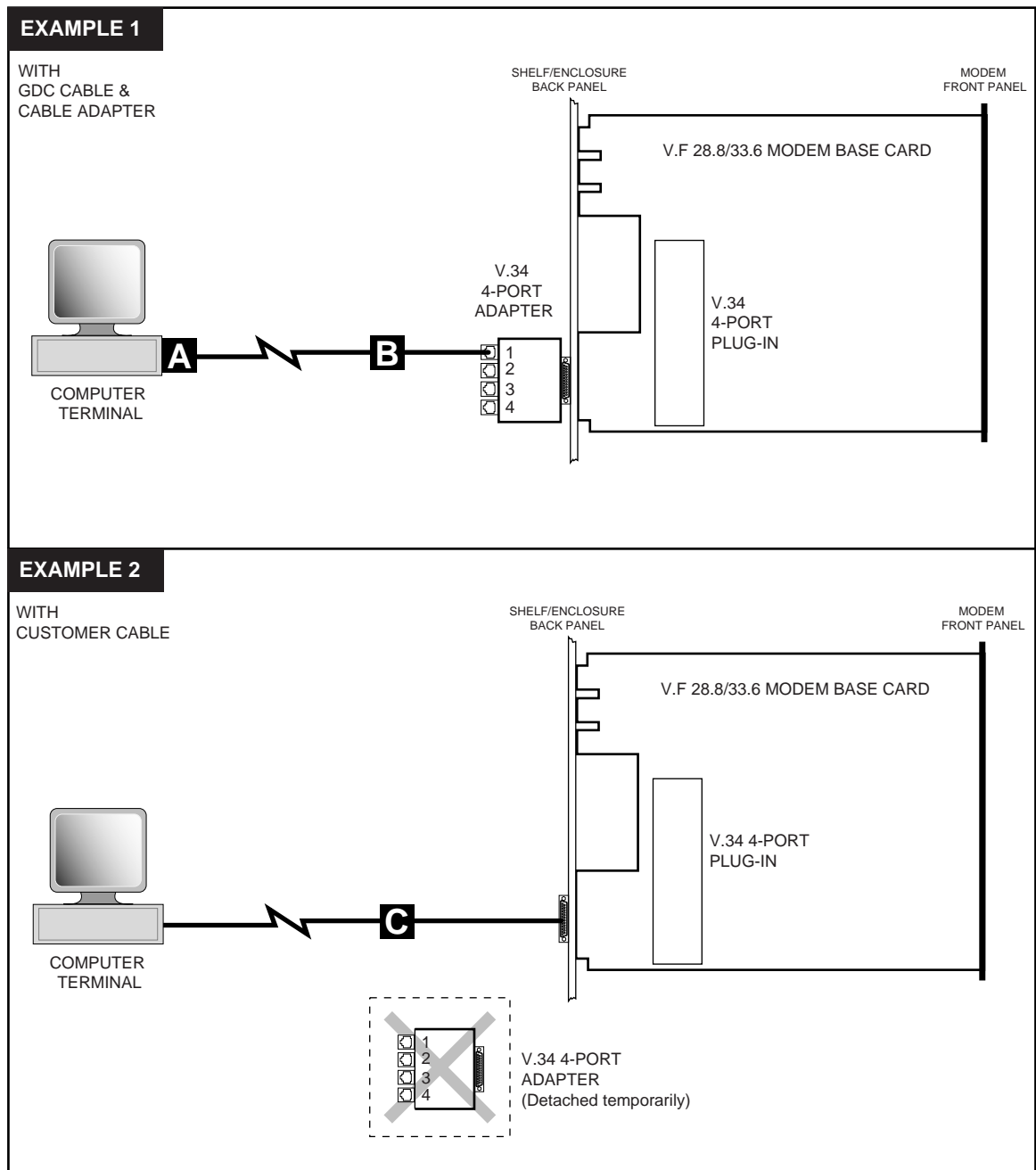

Figure 3-2 Examples: Terminal Connections to the V.34 4-Port Modem

#### 4-Port Configuration Procedure

1. Set up the modem for local or remote configuration as described above using the V.34 4-Port modem's **Port 1**.
2. Set the computer terminal's speed and the character format to match the equipment that will be connected to the modem's external 4-Port adapter, i.e., 9600bps, 8 Data, 1 Stop Bit, No Parity.
3. Type **AT%S2** to enable Online or RADIUS security.
4. Type **AT&W** then press **Enter** to save the security, configuration and DTE speed settings.

---

**Note** *If RADIUS Security is to be used with or instead of Online Security, perform the entire RADIUS setup for the modem, the SCM card and the customer-supplied RADIUS server. Refer to paragraphs on [RADIUS Security \(Remote Authentication for Dial-In Users\)](#) in this chapter.*

---

5. Type **AT%Pn=XXX** to store at least one cell password in the modem for Online Security where *n* is the cell number and *XXX* is the password.
6. Type **S2=128** to option the modem for Escape Code Characters Off.
7. Type **%K1** to option the modem for Abort Character Off.
8. Type **ATE0** to option the modem for Local Echo Off.
9. Type **ATQ1** to option the modem for Quiet Mode.
10. Type **AT&W** then press **Enter** to save the settings.
11. If the modem's external 4-port adapter was removed for this procedure, replace it now.
12. Connect the desired equipment to the modem's 4-port adapter using appropriate cables.

#### 4-Port Dial-In Procedure

1. Dial into the shelf or enclosure via the V.34 4-Port modem.
2. At the prompt, enter the cell password.  
If RADIUS is installed and enabled at the SCM and modem, enter the RADIUS username and password. At the next prompt, enter the Challenge reply if supported by the RADIUS server.
3. When access is granted, the V.34 4-Port prompt appears as follows:

**ENTER DTE NUMBER 1 TO 4**

4. You have 20 seconds to type a valid port number (1, 2, 3, or 4) and then press **Enter**.

If you make an invalid entry, or if the 20-second interval lapses, the V.34 4-Port prompt appears again as follows:

**ENTER DTE NUMBER 1 TO 4**

After the third re-prompt or after 60 seconds, the call will be disconnected with the following message displayed:

**USER TIME OUT OR NO DTE NUMBER**

5. A successful port number entry will cause the modem to display an **OK** confirmation. You are now able to pass data to whatever equipment is connected to that port.
6. To switch to a different port, disconnect the call, then repeat this procedure and select the desired port number.



## Private Line Operation

The V.F 28.8 modem can be configured to operate over a point-to-point, unconditioned, voice grade private line (speech band leased line). Point-to-point private lines rented from the telephone company are dedicated, direct, semi-permanent phone line connections between two locations. In applications that require a continuous data transfer between fixed points, it may be more economical to rent a private line at a fixed rate, than to pay monthly long distance charges for dial up calls. The communication link between two multiplexers will generally involve a modem operating over private lines.

---

**Note** *Speeds below V.32 4800 bps are not supported in private line operation.*

---

### Two-wire or Four-wire Selection

The V.F 28.8 modem is capable of operation on private line networks, using either 4-wire or 2-wire circuits.

- Use &L1 to select 2-wire operation or &L2 to select 4-wire operation.
- For proper private line connection, the 8-pin cable should be used to connect the modem's jack marked PL to the JM8 wall outlet supplied by your service provider.
- When using Factory Default 0 (&F0) to set up a private line connection, make all other option settings before issuing the &L1 or &L2 command. The modem will begin its training sequence at once when it is given the &L command.
- To abort training sequence and return to Command mode you can either press the SEL button three times or press the AL button.

### Other Configurations

In any private line connection, first designate one modem as the originate modem (%O0) and the other as the answer modem (%O1). Next, configure both modems for the type of communication they are intended to perform: normal or reliable modes (\N command), synchronous or asynchronous modes (&M command), DTE and VF modulation (\T and &P commands), etc.

Select &P0 (V.34 only), &P1 (V.32 bis only) or &P2 (V.32 only) to establish the desired modulation in private line.

---

**Note** *If an error-corrected link is desired, configure the modem for \N2 (MNP reliable mode) or \N4 (V.42 (LAPM) reliable mode) rather than \N3 (V.42/MNP auto-reliable mode).*

---

It is also possible to configure the modem for private line operation as above from the front panel.

### Transmit Level

It is possible in private line operation for the transmit levels of the modems to be either too low or too high. When that is the case the connection usually will not be dependable and will be filled with errors. To correct such situations, the transmit level of the V.F 28.8 for private line operation can be configured in 1 dBm increments between 0 dBm and -15 dBm. This selection is done with the :T command. See Chapter 4 for details.

---

**Note** *It is recommended that you permanently store the above settings by entering the &W command. The modems are now ready for private line communications.*

---

## Automatic and Manual Handshaking

The V.F 28.8 modems utilize a private line "idle" mode to facilitate the use of the AT command set for private line set up. The modems can be put into private line idle via the front panel talk/data switch (SEL key), AT command H, or the MMS command Private Line Talk/Data. If the modems are already trained and option changes are desired, a "+++" sequence can be used to enter command mode. After the changes are complete, an **O** command can be used to go back on line or an **H** command can be issued to go to idle. From idle, either the talk/data switch or **O** can be used to initiate a new connection. Once told to handshake, the modems will continuously try to complete a handshake. When this process is complete, the modem will display a **CONNECT** message on the DTE.

When communicating with a different modem in private line operations, the following steps outline how to configure the modems:

1. Configure both modems for the type of communications they are intended to perform.
2. Configure the V.F 28.8 modem as the ORIGINATE modem, using the %O0 command.
3. Again, use the &W command to permanently store the current configurations for both modems.

## Auto Dial Restoral

Auto Dial Restoral (ADR) allows the V.F 28.8 modem to attempt automatic restoration of the data link over a switched network line if the private line fails. Refer to Chapter 1, paragraphs: [SpectraComm V.F 28.8/33.6 Modem Models](#) to determine if your modem is capable of ADR operation.

When the originate modem goes into a retrain (because of poor signal quality or a line interruption), the private line down timer (S-Register 40) is activated. The modem will continue retrains until successful or until the timer expires. When a retrain is successful, the timer is reset. If the timer expires before there is a successful retrain, the modem will attempt a switched network connection by dialing the number stored in cell 0. (This number may have dial modifiers to link to another cell or redial as many times as desired.) The modem stays in switched network mode until the lookback function returns it to private line mode or until you manually disconnect the call. If the modem cannot establish the switched network connection, it reverts to private line mode and starts the process over.

The originate modem's private line lookback timer (S-Register 41) determines how long the modem will operate on the switched network connection before it tries to return to private line mode. When the private line lookback timer expires, the modem will attempt a private line handshake. When the private line connection is made, the modem will drop the switched network call. If the private line connection cannot be made, the modem will reset the timer and try again when the timer expires. (If the timer is disabled, the modem makes no attempts to return to the private line.)

There are two configurations for Auto Dial Restoral: restore the data link with a switched network connection to the same modem used in private line mode, or restore the data link with a switched network connection to a different modem (usually one in a modem pool).

---

**Note** *Character Abort should be disabled (Command %K1) in modems that will perform Auto Dial Restoral. If this is not done, data on the modem's interface leads can cause dialing to abort.*

---

### Auto Dial Restoral Guidelines

To restore the data link with a switched network connection to the same modem, ensure that:

- Both modems (originate and answer) must have Auto Dial Restoral enabled (**&Bn** command). Use **&B2** when dial restoral is expected to appear as a retrain. This is typical when the modem being dialed is the one on the answer end of the failed private line.
- Cell 0 of the originate modem must contain the phone number of the answer modem.
- The private line down timer for the originate modem must be enabled (S-Register 40 must be non-zero).
- Automatic answer for the answer modem must be enabled (S-Register 0 must be non-zero).
- The private line answer modem must be in a retrain or be idle to be able to answer a call.

To restore the data link with a switched network connection to a different modem, ensure that:

- The originate modem must have Auto Dial Restoral enabled (**&Bn** command). Use **&B1** when a line failure indication is required at the DTE (the DSR, CD and CTS signals operate according to their options between dial restoral and successful lookback operations). This is typical when the dial-back answer modem is in a modem pool.
- Cell 0 of the originate modem must contain the phone number of the answer modem.
- The private line down timer for the originate modem must be enabled (S-Register 40 must be non-zero).
- The answer modem can be any compatible switched network modem.

## Terminal Interface Function

GDC V.34 products housed in a SpectraComm shelf support a terminal interface for monitoring and configuration. Access to the terminal interface functions takes place through a SpectraComm Manager (SCM) card installed in the same shelf (or pair of shelves connected by daisy chain cables) with the V.F 28.8 unit. One SCM card can support interface functions for up to 15 units in a single shelf or up to 31 units in a pair of shelves.

### Initiating a Terminal Interface Session

The first portion of a terminal interface session varies depending on whether you're using a VT100-compatible terminal connected directly to the SCM front panel or a computer with a Telnet connection to the SCM LAN port.

#### VT100-compatible Terminal Connection

1. When you connect a terminal to the SCM front panel, the SCM Terminal Interface Main Menu is the first to appear, as shown below.

```

Main Menu
1. IP Address
2. Passwords
3. Element Access
4. Test
Next Selection:
  
```

2. Type **3** and press **Enter**. The screen then displays the Shelf Inventory screen.
3. To select a unit, proceed to the Shelf Inventory Screen paragraphs below.

---

**Note** *The other selections in this menu concern the SCM and are discussed in the SpectraComm Manager Card Installation and Operation Manual, GDC Publication Number 048R303-000.*

---

#### Telnet Connection

1. When you establish a Telnet connection to the SCM LAN port, the SCM Telnet Login screen is the first to appear, as shown below. (Refer to the *SpectraComm Manager Card Installation and Operation Manual*, GDC Publication Number 048R303-000 for instructions.)

```

Copyright (c) 1993-1999 General DataComm Industries
Inc.
All rights reserved
SCM Application Version 3.2

login:
  
```

2. After you enter the login password, the screen displays the Shelf Inventory screen.
3. Refer to the Shelf Inventory Screen procedures paragraphs below to select a unit.

---

**Note** *There is a 10-minute timeout on the terminal interface. If 10 minutes lapse without any keypresses, the unit terminates the session. The SCM Main Menu displays if you are using a terminal connected to the SCM front panel. The SCM login screen displays if you are using a Telnet connection.*

---

## Selecting a Unit (Shelf Inventory Screen)

From this point, procedures are the same for both types of connection. The Shelf Inventory screen below is for a typical two-shelf installation. The two columns for Slots 17 through 32 do not appear when there is only one shelf.

Slot	Card	Slot	Card
[1]	SCM	[17]	DUAL V.34
[2]	SC5001	[18]	DUAL V.34
[3]	SC5034	[19]	DUAL V.34
[4]	SC5034	[20]	DUAL V.34
[5]	SC5034	[21]	DUAL V.34
[6]	SC5034	[22]	DUAL V.34
[7]	SC5034	[23]	DUAL V.34
[8]	SC5034	[24]	DUAL V.34
[9]	SC5034	[25]	VF288
[10]	SC5034	[26]	VF288
[11]	SC5034	[27]	VF288
[12]	SC5034	[28]	VF288
[13]	SC5034	[29]	VF288
[14]	SC5034	[30]	VF288
[15]		[31]	VF288
[16]		[32]	
[0]	Close Session	[C]	Circuit Identification
Enter selection:			

**Figure 3-3** SCM Terminal Interface Shelf Inventory

The Shelf Inventory displays the word "alarm" in parentheses next to the name of any unit that currently has an active alarm condition.

Type the slot number of the unit you intend to work with, and press the Enter key. If the selected unit is a V.F 28.8 modem, it displays the Main Menu that is shown in [Figure 3-4](#).

**Note** You can return directly to the Shelf Inventory screen from any V.34 terminal interface screen by pressing the Control (Ctrl) key and the letter C at the same time.

SPECTRACOMM VF 28.8	
SLOT: 04 LINE: 1	
[1] AT SESSION	[2] ALARMS
[3] DTE STATUS	[4] CALL STATISTICS
[0] RETURN TO SHELF INVENTORY	
Select:[ ]	

**Figure 3-4** V.34 Terminal Interface Main Menu

## AT Session

The AT Session selection from the Main Menu enables you to perform configuration by means of the terminal interface. Making this selection prepares the unit to accept a subset of the AT commands that includes the configuration commands and commands that query the unit for information, such as set help, identification or checksum. The following commands cannot be used during a terminal interface AT Session:

- Remote configuration
- Call control (dialing or answering)
- Test functions
- Repeat last command (**A/**)
- Escape sequence (**+++**) to place a unit configured for private line operation into command mode

---

### Note

*The unit can be configured via the **%Vn** command to accept configuration commands in the AT format or in any one of three V.25 bis formats. Selecting AT Session through the terminal interface automatically forces the unit into the AT command mode.*

*If you intend the unit to accept V.25 bis commands, be sure to make the **%V** setting at the end of the AT Session. If you need to save a User Configuration Profile with **%V** set for V.25 bis commands, you must include that command (**&Wn**) on the same line with the **%V** command. Once you press the Enter key to put the command line into effect, the unit cannot accept any further standard AT commands.*

---

The AT parser that acts on the commands is located in DTE interface circuitry. Therefore, the unit can only accept AT commands while it is off-line (idle mode). If you attempt an AT session while the unit is in data mode, it responds with the message:

**WARNING: THE MODEM IS ON LINE. Do you wish to Continue? (Y/N):**

If you do not want to interrupt the connection, type **N** and press **Enter**. The terminal interface display returns to the Main Menu.

## Switched Line Units

Perform the following steps for a terminal interface AT Session when the selected unit is configured for switched line operation:

1. At the Main Menu screen, type **1** and press **Enter**.
2. If the selected unit is on-line, the screen displays the message:
 

**WARNING: THE MODEM IS ON LINE. Do you wish to Continue? (Y/N):**
3. Type **Y** and press **Enter** to make the unit disconnect and enter the AT Session. If you choose not to interrupt communications, type **N** and press **Enter**.
4. When you're in the AT Session, either because the selected unit was not on-line or because you had it disconnect, the screen displays the message:

**To Exit AT Mode and Return to Main Menu, use the "AT<" Command !**

5. Type AT commands to the unit just as you would from the DTE.
6. When you are done entering commands, type **AT<** and press **Enter**. The display returns to the Main Menu screen.

### Private Line Units

Perform the following steps for a terminal interface AT Session when the selected unit is configured for private line operation.

1. At the Main Menu screen, type **1** and press **Enter**. The screen displays the message:  
**WARNING: THE MODEM IS ON LINE. Do you wish to Continue? (Y/N):**
2. Type **Y** and press **Enter** key to make the unit disconnect and enter the AT Session. The screen then displays the message:  
**To Exit AT Mode and Return to Main Menu, use the "AT<" Command !**
3. Because it is configured for private line operation, the unit immediately begins retraining to return on-line. The retrain process takes about 20 seconds, during which the unit can accept AT commands. The procedure that follows extends the time available for inputting AT commands.
4. Begin the AT Session by checking and recording two details from AT help screens so you can be sure to restore the settings correctly at the end of the AT Session:
5. Type **AT &\$** and press **Enter** to display the current settings of the AT & options. Write down the setting of the &L option that determines what network type (switched, 2-wire private, or 4-wire private) the unit operates in.
6. Type **AT %\$** and press **Enter** to display the current settings of the AT % options. Write down the setting of the %O option that determines which band (originate or answer) the unit transmits on.
7. Type **AT &L0** and press **Enter** to place the unit into switched line mode so that it does not retrain. As long as the unit you are working with remains in switched line mode, the modem at the far end of the private line continues unsuccessful attempts to retrain.
8. Proceed to perform whatever configuration you need to on the unit, typing AT commands just as you would from the DTE. When complete, check the **AT %** option settings again to be sure that %O is set correctly.
9. Type the **&L** command to restore the unit to its original private line mode.
10. If you intend to save the configuration as a User Profile (**&W** command) do so immediately after you restore the unit to private line mode.
11. Type **AT<** and press **Enter**. If the unit has not completed retraining it returns to the Main Menu screen. If it has reconnected and there is no response, type **AT<** and press **Enter** to return to the Main Menu.

## Alarms

The terminal interface Alarms screen, shown below, displays the status of alarm conditions (**ON** or **OFF**) for each alarm condition, indicating whether the condition currently exists. Definitions of the alarm conditions are provided below. To dismiss the screen, press **Enter**.

Screen data reflects conditions at the moment you accessed the screen. To update the display, dismiss the screen and then selecting it again from the Main Menu by pressing the **Enter** key.

```

SPECTRACOMM VF 28.8
SLOT: 04  LINE: 1
ALARMS

ALARM      STATUS      ALARM      STATUS
-----
NO DTR:    OFF        CONFIG CKSUM ERR:  OFF
NO TXD:    ON         CALL FAILED:       OFF
NO RXD:    ON         CALL LENGTH:       OFF
ON DBU:    OFF        RING NO ANSWER:   OFF
DCD LOSS:  ON         TEST TIMED OUT:   OFF
RETRAIN:   OFF

Hit a <CR> to Continue:

```

**Figure 3-5** Terminal Interface Alarms Screen

## Alarms

No DTR – indicates the unit is not receiving Data Terminal Ready from the DTE

No TXD – occurs when a unit configured for constant TX carrier experiences one minute without transitions in the Transmit Data

No RXD – occurs when a unit configured for constant RX carrier experiences one minute without transitions in the Receive Data

On DBU – occurs when a modem that normally operates on a dedicated line connection has initiated a switched network connection due to problems with the dedicated line

DCD Loss – indicates loss of incoming data

Retrain – occurs when the number of retrains exceeds the configured retrain count threshold

Config Checksum Err – indicates that the non-volatile memory that stores configuration has become corrupted

Call Failed – can occur for a variety of reasons; check the Call Statistics screen for more detailed information when a Call Failed alarm occurs

Call Length – occurs when the duration of a call exceeds the configured call length threshold

Ring No Answer – occurs when an incoming call rings but the modem does not answer

Test Timed Out – occurs when a diagnostic test is ended automatically by the configured Test Time limit



## Call Statistics

The terminal interface Call Statistics screen, shown below, displays statistics on the current or most recent connection by the unit. If the unit is on-line when you display the screen, the statistics are those for the current connection. If it isn't on-line, it displays the statistics of the most recently completed connection. To dismiss the screen, press **Enter**.

Screen data reflects conditions at the moment you accessed the screen. To update the display, dismiss the screen and then selecting it again from the Main Menu by pressing the **Enter** key.

```

SPECTRACOMM VF 28.8
SLOT: 04  LINE: 1
CALL STATISTICS

DTE RATE:           9600
DCE TX RATE:        00000
DCE RX RATE:        00000
CALL LENGTH (Sec):  00000
RETRAIN COUNT:      00
FALLBACK COUNT:     00
FALLFORWARD COUNT:  00
RX SIGNAL LEVEL(dB): -00
SNR(dB):            00
CONNECT PROTOCOL:   NONE
CONNECT MODE:       ORG

Hit a <CR> to Continue:

```

**Figure 3-6** Terminal Interface Call Statistics Screen

The Call Statistics window displays the following information:

DTE Rate – the speed, in bps, of the data exchange between the unit and its DTE

DCE Tx Rate – the speed, in bps, at which the transmitter connected to the remote modem

DCE Rx Rate – the speed, in bps, at which the receiver connected to the remote modem

Call Length (Sec) – up to 65535 seconds. During a current call, displays duration at the time the screen was accessed.

Retrain Count – number of times the unit had to perform a retrain sequence during the call (0 to 127)

Fallback Count – number of times the unit performed fallback to a lower connection speed during the call (0 to 127)

Fall Forward Count – number of times the unit performed fall forward to a higher connection speed during the call (0 to 127)

RX Signal Level – 0 to -48dBm

Signal-to-Noise Ratio – 0 to 40dB

Connect Protocol – protocol used to manage the connection, determined by the modems during handshake. When this displays NONE the modem is off-line and the statistics being displayed are from the last completed call.

Connect Mode – mode, Originate or Answer, in which local unit performed handshake to initiate connection

## DTE Status

The terminal interface DTE Status screen, shown below, displays the current status of eight DTE interface signals (**OFF** or **ON**). To dismiss the DTE Status screen and return to the Main Menu, press **Enter**.

Screen data reflects conditions at the moment you accessed the screen. To update the display, dismiss the screen and then selecting it again from the Main Menu by pressing the **Enter** key.

```
SPECTRACOMM VF 28.8
SLOT: 04  LINE: 1
DTE STATUS

RTS:      OFF          CTS:      ON
DTR:      ON           DSR:      OFF
RING:     OFF          DCD:      OFF
CLK:      ON           TM:        OFF

Hit a <CR> to Continue:
```

**Figure 3-7** DTE Status Screen

---

# Chapter 4: AT Command Set Operation

---

## AT Command Overview

The V.F28.8/33.6 modem supports the **AT** (**AT**tention) command set, which includes the basic **AT** command set and the extended commands sets: **AT&**, **AT%**, **AT\**, **AT:**, and **AT\***. These commands allow the user to obtain information from the modem, configure the modem, establish data communications, test the modem and data communications system

In this chapter, a description of each command is provided in [AT Command Reference Tables](#) which lists each command in alphabetical order along with its available options. Additional information such as procedures and special considerations is provided for certain commands at the end of this chapter in [AT Command Details](#).

## AT Command Guidelines

Upon installation and/or powerup, the modem will be in the command mode and able to accept **AT** commands from the terminal. The following guidelines should be understood by the user when issuing **AT** commands to the modem:

- Each command line must be preceded by the letters **AT** and followed by a carriage return (**Enter**). The only exception to this rule is the **A/** command.
- The **A/** is used to repeat the last command entered. This is the only command that can be issued without the **AT** prefix.
- The modem acts on the command line only. The **AT** prefix, space, carriage return and line feed characters are not considered as part of the command line.
- When **AT** is entered, the modem detects the data rate and parity used by the terminal and begins operating at that same data rate and parity until it gets changed.
- Up to 40 **AT** command characters may be entered. Command lines that exceed 40 characters will not be executed.
- A carriage return character (**Enter**) must be entered at the end of the command line in order for the modem to process the command(s).
- Mistakes in the command line may be corrected by using the backspace key to move the cursor over the character to be corrected. The **AT** prefix cannot be deleted in this manner.
- After a command line is entered, the modem responds by sending a result code back to the terminal. The terminal displays **OK** for a valid command return, and displays **ERROR** for invalid return. Result codes will be ignored if the result code function is disabled or if the communications software running on a computer emulating a terminal ignores result codes. New commands cannot be issued until a response to the previous command is received. If there is no response, a wait of three character times is required before the next command. If the DTE rate is changed, then 1 second must elapse.

### AT Command Procedures

#### AT Command Setup

1. Install the V.F 28.8/33.6 modem as described in Chapter 2.
2. Select the proper communications port on the terminal or terminal emulator program and ensure 10 bit ASCII is selected.
3. If a communications software package is being used, it will interface with the modem and no further setup is required. Refer to the documentation for the communication software package.
4. If the modem is being used interactively on a terminal or with a terminal emulation package, issue **AT\$** and then press **Enter**.
5. If the V.F 28.8/33.6 modem is connected properly, it will respond to the command by displaying the basic AT command set help menu.
6. Use the commands as described in this Chapter to configure and operate the modem as required.

---

**Note** *ITU-T V.13 simulated carrier (&En) and flow control (\Qn) options override the &Rn settings for CTS in data mode.*

---

#### S-Register Command Examples

*Example:* To view the value of S-Register 2, type:

```
ATS2?<cr>
```

The response might be:

```
005<cr><lf>
```

```
OK<cr><lf>
```

*Example:* To set the value of S-Register 2 to equal 5, type:

```
ATS2=5<cr>
```

*Example:* To view the value of the last S-Register that was queried, type:

```
AT?<cr>
```

## AT Command Reference Tables

This section provides a description of the basic and extended **AT** commands. They are in alphabetical order, grouped with command variations, if any. All commands are assumed to be preceded by an **AT** and followed by a carriage return. The only exception is the **A/** command, which is used to repeat the last **AT** command that was entered.

<b>\$</b>	AT command set help	Displays the help menu for the basic AT command set.
<b>&amp;\$</b>	AT& command set help	Displays the help menu for the extended AT& command set.
<b>;%</b>	AT% command set help	Displays the help menu for the extended AT% command set.
<b>\\$</b>	AT\ command set help	Displays the help menu for the extended AT\ command set.
<b>: \$</b>	AT: command set help	Displays the help menu for the extended AT: command set.
<b>* \$</b>	AT* command set help	Displays the help menu for the extended AT* command set.
<b>S\$</b>	S-Register help	Display the S-Register help menu. Only S-Registers not containing bit mapped options will be displayed.
<b>A</b>	Answer call	Instructs the modem to answer an incoming call. It is used to go off-hook and generate the proper answer sequence.
<b>&amp;An</b>	Automatic fallback/ fallforward	Controls the automatic fallback and fallforward capabilities.
		<b>&amp;A0</b> Disables the fallforward/fallback feature.
		<b>&amp;A1</b> Enables the fallforward/fallback feature. Only functions when the modem is optioned for synchronous data mode or for asynchronous with speed buffering, and only for V.34, V.32, and V.32 bis modes.
<b>%An</b>	Auto-reliable fallback character	Selects the ASCII character number (0 - 127) that the modem uses with auto-answer to negotiate an auto-reliable (N3) error correcting link on the VF line. If the modem detects two successive fallback characters, it will terminate the negotiation process and go directly to a non-error correcting mode. The <b>\C</b> command determines which non-error correcting mode (wire or direct) the modem will fall back to, and what will become of data transferred to the modem during the negotiation process. Refer to Appendix A: <a href="#">ASCII Character Set</a> for a listing of the ASCII characters.
<b>An</b>	Overspeed correction	Selects overspeed correction for V.14 asynchronous data modes.
		<b>\A0</b> Selects 1.25% (nominal) overspeed correction.
		<b>\A1</b> Selects 2.5% (extended) overspeed correction.
<b>A/</b>	Repeat command	Re-executes the most recent AT command line sent to the modem. This command can instruct the modem to redial a previous number when a handshake attempt fails.
<b>&amp;Bn</b>	Auto Dial Restoral	Controls Auto Dial Restoral.
		<b>&amp;B0</b> Disables Auto Dial Restoral.
		<b>&amp;B1</b> Enables Auto Dial Restoral, with line failure indicator.
		<b>&amp;B2</b> Enables Auto Dial Restoral, without line failure indicator.
<b>%Bn</b>	Make busy	Controls the Make Busy option.
		<b>%B0</b> Make busy disabled.
		<b>%B1</b> Make busy on loss of DTR.
		<b>%B2</b> Make busy in ANALOOP (ITU-T V.54 Loop 3 test)
		<b>%B3</b> Make busy on loss of RTS, loss of DTR, or in ANALOOP (ITU-T V.54 Loop 3 test).
		<b>%B4</b> Make busy on loss of RTS.

\Bn	Character length	Sets up the character length and format used by the modem in data mode for front ends that do not send AT commands. The character length includes start, data, parity, and stop bits.
		\B0 6N1; Character length = 8 bits (6 data)
		\B1 7N1; Character length = 9 bits (7 data)
		\B2 7P1; DEFAULT Character length = 10 bits (7 data, 1 parity). With automatic parity enabled (\P4), this also accommodates 8 data bits with no parity.
		\B3 8N1; Character length = 10 bits (8 data)
		\B4 7P2; Character length = 11 bits (7 data, parity, 2 stop) Not supported by the V.42 and MNP protocols (\N2 through \N5).
		\B5 8P1; Character length = 11 bits (8 data, parity). Not supported by the V.42 and MNP protocols (\N2 through \N5).
&Cn	DCD operation	Controls the EIA Data Carrier Detect signal.
		&C0 Selects DCD to be forced On.
		&C1 Selects DCD to be On after link established.
		&C2 Selects DCD to be forced On; Toggle Carrier On disconnect.
		&C3 Selects Real mode (follows modem energy detection).
%Cn	Data compression	Controls the selection of data compression for MNP-5 reliable, V.42 <i>bis</i> reliable, and synchronous data links.
		%C0 Disables data compression.
		%C1 Enables data compression in both directions.
		%C2 In V.42 <i>bis</i> or synchronous, enables data compression in the transmitter path. In MNP 5, enables data compression in both directions.
		%C3 In V.42 <i>bis</i> or synchronous, enables data compression in the receiver path. In MNP 5, enables data compression in both directions.
\Cn	Fallback selection and pre-link data buffer	Determines fallback selection. If an error correcting protocol is enabled, this command determines whether incoming data from the remote modem will be buffered while the receiver modem waits for establishment of the error correction link.
		\C0 Receiver modem discards all incoming VF data from the remote modem until it has sent a <b>PROTOCOL: NONE</b> message to its DTE. Receiver modem then passes data through.
		\C1 Receiver modem buffers incoming VF data (up to 200 characters) until it has sent a <b>PROTOCOL: NONE</b> message to its DTE. It then passes the buffered data through to the DTE. The modem will fall back to wire mode if more than 200 characters are received before an error correction link is established.
		\C2 Receiver modem discards all incoming VF data until it detects two consecutive fallback characters (%An), and then falls back to wire mode. The receiver modem passes one fallback character through to its DTE as data.
		\C3 Same as \C1, except that with no link the modem falls back to V.14 (direct) mode.
		\C4 Same as \C2, except that with no link the modem falls back to V.14 (direct) mode.

<b>Dn</b>	Dial	This command, followed by the phone number to be dialed, directs the modem to go off-hook and dial the number. Commands other than dial modifiers must not be placed after the D command. Any command that is placed after the D is either ignored or interpreted as a dial command modifier.
		<b>T</b> Selects the numbers to be tone dialed.
		<b>P</b> Selects the numbers to be pulse dialed (if permitted by country code).
		<b>Sn</b> Selects a stored phone number to be recalled and dialed. The modem's default when the AT command DS is issued is to dial the phone number stored in cell 0. ( <i>n</i> = 0 to 9)
		<b>R</b> Switches modem operation to handshake in the answer mode when this command appears as the last character in the dial string.
		<b>, or &lt;</b> Pauses dialing for a programmable length of time determined by S-Register 8. Default is 2 seconds.
		<b>W</b> Directs the dialer to wait for a dial tone before continuing the dial string.
		<b>@</b> Directs the dialer to wait for a quiet answer before continuing the dial string.
		<b>!</b> Directs the dialer to place a 1/2 second hook-switch flash in the dial string.
		<b>;</b> Directs the dialer to return the modem to command mode.
		<b>:n</b> Directs the dialer to redial the attempted dial string up to <i>n</i> times if the modem does not achieve data mode.
		<b>Ln</b> Directs the dialer to dial phone cell <i>n</i> if the modem fails to achieve data mode with the current dial string.
		<b>\n</b> Remote modem uses cell <i>n</i> for Security Callback.
		<b>A</b> Causes the DTMF A tone to be generated.
		<b>B</b> Causes the DTMF B tone to be generated.
		<b>C</b> Causes the DTMF C tone to be generated.
		<b>D</b> Causes the DTMF D tone to be generated.
		<b>0 - 9</b> Tone or pulse dials the number. (A, B, C, and D are ignored in Pulse mode.)
		<b>J</b> Performs MNP10 link negotiations at 1200 bps (this call only). See *H.
		<b>K</b> Enables power level adjustment during MNP10 link negotiation (this call only). Refer to <b>)M</b> command.
<b>&amp;Dn</b>	DTR On-to-Off transition	Controls the result of On-to-Off transitions of Data Terminal Ready.
		<b>&amp;D0</b> Causes the modem to ignore Off transitions and forces internal DTR On.
		<b>&amp;D1</b> Causes the modem to change to command mode when it senses an Off transition during an established data link.
		<b>&amp;D2</b> Causes the modem to recognize Off transitions of DTR and respond by hanging up.
		<b>&amp;D3</b> Same as <b>&amp;D2</b> , and also causes the modem to perform AT command <b>Z</b> .
<b>%Dn</b>	DSR operation in test mode	Specifies whether Data Set Ready (DSR) will be On or Off during an ANALOOP test.
		<b>%D0</b> DSR will turn On whenever the modem is operating an ANALOOP test.
		<b>%D1</b> DSR forced Off when in an ANALOOP test.
<b>En</b>	Local DTE echo	Controls the status of local echo.
		<b>E0</b> Turns the local echo Off.
		<b>E1</b> Turns the local echo On.

<b>&amp;E<math>n</math></b>	Simulated controlled carrier	Controls the selection of V.13 modes.
		<b>&amp;E0</b> Selects Bi-directional V.13.
		<b>&amp;E1</b> Selects V.13 TX side enabled.
		<b>&amp;E2</b> Selects V.13 RX side enabled.
<b>%E<math>n</math></b>	DTE interface-controlled tests	Determines whether tests can be controlled by DTE interface leads.
		<b>%E0</b> Tests cannot be commanded by signals on the DTE interface. <b>%E1</b> The modem will perform the ANALOOP (AL) test under command of Pin 18, and the remote digital loop (RDL) test under command of Pin 21 of the DTE interface.
<b>&amp;F<math>n</math></b>	Load fixed configuration profile	Loads the modem with factory-defined settings for a fixed configuration profile. Refer to <a href="#">Table 4-1</a> for a detailed list of settings for the four fixed configuration profiles.
		<b>&amp;F0</b> Selects asynchronous switched network operation, with V.42 error correction and V.42 <i>bis</i> data compression.
		<b>&amp;F1</b> Selects synchronous switched network operation.
		<b>&amp;F2</b> Selects asynchronous two-wire private line operation.
		<b>&amp;F3</b> Selects synchronous two-wire private line operation.
<b>%F<math>n</math>=<math>x</math></b>	Password cell qualifier	Determines which callback extensions, if any, can be used with the password stored in a specified memory cell, where $n$ represents the memory cell (0-9). This command does not affect use of the fixed callback extension <b>,F</b> which is administered by an MMS controller.
		<b>%F<math>n</math>=0</b> Disables the callback extensions stored with the password in cell $n$ . The modem will terminate any call which sends that password with a callback extension attached.
		<b>%F<math>n</math>=1</b> Permits the roving callback extension <b>,R</b> to be used with the password stored in cell $n$ . The password can be used without an extension, but the use of any extension other than <b>,R</b> will cause the modem to terminate the connection.
		<b>%F<math>n</math>=2</b> Permits the phone cell callback extension <b>,C</b> to be used with the password stored in cell $n$ . The password can be used without an extension, but the use of any extension other than <b>,C</b> will cause the modem to terminate the connection.
		<b>%F<math>n</math>=3</b> Permits the use of either the roving <b>,R</b> or phone cell <b>,C</b> callback extension with the password stored in cell $n$ . The password can be used without an extension.



<b>&amp;G<math>n</math></b>	DCE rate limit	Sets the maximum rate for the modem to make a VF connection to a remote modem. The allowable rates are: 2.4 to 28.8 kbps for V.34, 4.8 or 9.6 kbps for V.32 only, and 4.8 to 14.4 kbps for V.32 <i>bis</i> only. If you set a rate that is outside the range of rates available for the modulation in use, the modem will use the closest available rate.
		<b>&amp;G5</b> 4.8 kbps, maximum rate
		<b>&amp;G6</b> 7.2 kbps, maximum rate
		<b>&amp;G7</b> 9.6 kbps, maximum rate
		<b>&amp;G8</b> 12 kbps, maximum rate
		<b>&amp;G9</b> 14.4 kbps, maximum rate
		<b>&amp;G10</b> 16.8 kbps, maximum rate
		<b>&amp;G11</b> 19.2 kbps, maximum rate
		<b>&amp;G12</b> 21.6 kbps, maximum rate
		<b>&amp;G13</b> 24 kbps, maximum rate
		<b>&amp;G14</b> 26.4 kbps, maximum rate
		<b>&amp;G15</b> 28.8 kbps, maximum rate
		<b>&amp;G16</b> 31.2 kbps, maximum rate
		<b>&amp;G17</b> 33.6 kbps, maximum rate (DEFAULT)
<b>\G<math>n</math></b>	Modem-to-modem flow control	Provides modem-to-modem flow control for non-error corrected data links that require a constant speed DTE interface (Wire Mode).
		<b>\G0</b> Disables flow control between the two modems.
		<b>\G1</b> Enables bidirectional modem flow control based on XON/XOFF signaling. The XON/XOFF signals are detected, acted on, and deleted from the data stream.
		<b>\G2</b> Provides unidirectional flow control: the modem may send XON/XOFF signals to the remote modem, yet ignore and pass through to its DTE any that it receives as VF signals.
		<b>\G3</b> Same as <b>\G1</b> , except after they are acted upon, XON/XOFF signals are passed through to the DTE instead of being deleted.
<b>H<math>n</math></b>	Hookswitch	Controls the off-hook relay.
		<b>H0</b> Opens the relay for on-hook condition (modem hang-up).
		<b>H1</b> Closes the relay for off-hook condition. Modem remains off-hook until termination of on-line status, or until the <b>H0</b> command is issued.

<b>&amp;Hn</b>	Switched network handshake mode	Controls the selection of the switched network hand-shake mode. When the modem is optioned for an external transmit clock source <b>&amp;X1</b> the modem should be optioned for a fixed hand-shake mode, not an automatic hand-shake mode (e.g., select V.32 bis only [ <b>&amp;H3</b> ] instead of V.32 bis automatic [ <b>&amp;H2</b> ]). The modem will then handshake only at the speed given to it by the DTE. For 1200 bps V.22 operation, select <b>&amp;H7</b> . <b>&amp;H6</b> is an auto mode, so setting the DTE to 1200 bps <b>\T3</b> will not force the connection to 1200 bps.
		<b>&amp;H0</b> Selects V.34 auto (28.8 - 300)
		<b>&amp;H1</b> selects V.34 only (28.8 - 2400)
		<b>&amp;H2</b> selects V.32 <i>bis</i> automatic (14.4 - 300)
		<b>&amp;H3</b> selects V.32 <i>bis</i> only (14.4 - 4800)
		<b>&amp;H4</b> selects V.32 automatic (9600 - 300)
		<b>&amp;H5</b> selects V.32 only (9600 - 4800)
		<b>&amp;H6</b> selects V.22 <i>bis</i> only (2400 - 1200)
		<b>&amp;H7</b> selects V.22 only (1200)
		<b>&amp;H8</b> selects 212 only (1200)
		<b>&amp;H9</b> selects 103 only (300)
<b>&amp;H10</b> selects V.21 only (300)		
<b>%Hn</b>	Private line heartbeat	Sets the value, in half minute intervals, for transmissions of the <b>H &lt;CR&gt;</b> heartbeat on an idle line, where <i>n</i> = 0 to 255.
<b>*Hn</b>	MNP10 Link Negotiation Speed	Controls the connection speed for link negotiations before up-shift occurs.
		<b>*H0</b> Link negotiations occurs at the highest supported speed.
		<b>*H1</b> Link negotiations occurs at 1200 bps; used primarily for establishing cellular connections.
		<b>*H2</b> Link negotiations occurs at 4800 bps; used primarily to negotiate an MNP10 connection on less-than average quality telephone lines.
<b>In</b>	Identification and checksum	Requests modem identification and checksum codes to be transmitted to the DTE.
		<b>I0</b> Displays the modem product code. The V.F 28.8/33.6 product code is 288.
		<b>I1</b> Displays the stored checksum calculated for the modem's configuration.
		<b>I2</b> (reserved for future use)
		<b>I3</b> Displays the revision level of the modem's firmware (an alphabetical character) followed by the OK message.
		<b>I4</b> Displays the following modem feature information: <b>Firmware Level</b> - Displays revision level by <b>I3</b> <b>Product Type</b> - Displays product code by <b>I0</b> <b>Management System</b> - Displays On/Off status of MMS control <b>Sync Compression</b> - Displays On/Off status <b>Leased Line</b> - Displays On/Off status. When OFF, modem is configured for switched network only operation
		<b>I5</b> Displays modem serial number.
<b>&amp;I</b>	Front Panel Lockout	Controls the modem's front panel switches.
		<b>&amp;I0</b> enables front panel.
		<b>&amp;I1</b> disables front panel.

%K <i>n</i>	Character abort	Controls the character abort option. It is only available when the modem is in AT operation and asynchronous mode.
		%K0 Enables character abort: any character typed at the DTE within 2 seconds after the modem goes off-hook will abort the dialing process.
		%K1 Disables character abort. With 4-Port operation, it is strongly recommended to option the modem for %K1.
\K <i>n</i>	Break character handling	Determines how the modem will react to break characters received from the DTE during an error corrected data link.
		\K0 Modem will immediately transmit a break character for a fixed time (300 ms) and destroy any currently buffered data.
		\K1 Same as the \K0 option, except all buffered data will be saved.
		\K2 Modem will transmit a fixed time break character in sequence with the rest of the data (default).
		\K3 Modem will ignore all breaks received from the DTE.
		\K4 Modem will transmit break characters in sequence with the rest of the data as long as the DTE is transmitting this character.
		\K5 Same as \K4 - required for compatibility with some communication software.
&L <i>n</i>	Network type	Sets the modem for private line or switched network lines.
		&L0 Switched network mode.
		&L1 2-wire private line mode.
		&L2 4-wire private line mode.
&M <i>n</i>	Operating mode	Selects between asynchronous and synchronous operation in data mode. See the %V <i>n</i> command to select command mode format.
		&M0 Selects asynchronous operation in data mode. See the \N <i>n</i> command to select an asynchronous protocol.
		&M1 Selects synchronous operation in data mode. See the \M <i>n</i> command to select a synchronous protocol.
\M <i>n</i>	Synchronous protocol	Selects the synchronous protocols that are available to the modem.
		\M0 Selects normal synchronous mode.
		\M1 Selects synchronous V.13, simulated controlled carrier, mode. Select transmit, receive, or bidirectional with &E <i>n</i> command.
		\M2 Selects synchronous data compression mode. Modem must be configured for internal transmit timing, and either Clock Stopping (\Q5) or Clock Throttling (\Q6) flow control.
-M <i>n</i>	MNP10 Mode	Controls MNP10 mode.
		-M0 Disables MNP10.
		-M1 Enables MNP10 Auto Reliable mode for central site operations (recommended setting).
		-M2 Enables MNP10 reliable mode (will not fallback to V.42/V.42bis).

<b>)Mn</b>	Cellular Power Level Adjustment	<p>Controls the automatic power adjustment of the transmit power level to accommodate the signaling requirements of cellular telephone equipment.</p> <p>For both cellular and land based originate or answer modes, if <b>)M1</b> is set, the transmit power level used for non-MNP10 or fax connections is the <b>@Mn</b> value. The <b>)M1</b> setting should not be used when *H2 is selected.</p>
	<b>)M0</b>	Disables transmit power level adjustment during MNP10 link negotiation. The <b>)M0</b> command allows the transmitter adjustment if cellular operation is requested by the remote modem (recommended).
	<b>)M1</b>	Enables transmit power level adjustment during MNP10 link negotiation. Uses the <b>@Mn</b> value to establish initial cellular connection. After connection, the optimal power level is determined by the modem.
<b>@Mn</b>	Initial Cellular Power Level Settings	Sets the initial transmit power level for up-shift at connect until line conditions can be determined. Levels can be set from -10 dBm to -31 dBm.
	<b>@M0</b>	Initial transmit power level of -30 dBm (recommended).
	<b>@M1</b>	Initial transmit power level of -26 dBm.
	<b>@M2-@M10</b>	Initial transmit power level of -10 dBm
	<b>@M11-@M31</b>	Initial transmit power level of -11 dBm to -31 dBm, respectively.
	<b>J</b>	Performs MNP10 link negotiation at 1200 bps (this call only). See <b>*H1</b> command.
	<b>K</b>	Enables power level adjustment during MNP10 link negotiation (this call only). See <b>)M1</b> command.
<b>N?</b>	Country code	Displays the current country the modem is configured for. In general, the country code displayed is the country's international calling code.
<b>\Nn</b>	Asynchronous protocol	Selects the various possible asynchronous protocols the modem is allowed to negotiate upon establishing a data link.
	<b>\N0</b>	Options the modem to run in wire mode, performing speed buffering by copying characters from the VF port to the DTE port and vice versa.
	<b>\N1</b>	Options the modem to run in direct mode: the DTE and VF speeds must match, and there is no speed buffering. Direct mode is V.14 asynchronous mode.
	<b>\N2</b>	Limits error correction to MNP links only, or hang up.
	<b>\N3</b>	Options the modem to run in auto reliable mode, and to negotiate V.42 or alternate links. With no link, the modem enters wire mode (speed buffering).
	<b>\N4</b>	Limits error correction to a V.42 (LAPM) link only, or hang up.
	<b>\N5</b>	Options the modem to attempt either a V.42 (LAPM) or MNP link. If either link fails, the modem will hang up.
<b>\N6</b>	Selects the use of V.13 simulated controlled carrier operation.	
<b>On</b>	On-line	Instructs the modem to go on-line (enter data mode) after an escape to local command mode is issued. This command transfers the modem from command mode to data mode.
	<b>O0</b>	Instructs the modem to go on-line.
	<b>O1</b>	Instructs the modem to go on-line and issue a retrain sequence if operating in V.34, V.22 bis, V32, or V32 bis modes.

<b>%On</b>	Answer mode	<p>For a modem on a switched network this command selects the band the modem will use for both automatically and manually answered calls. For a modem on a private line, this command selects the band the modem will use for connections.</p> <p><b>%O0</b> Commands the modem, in switched network mode, to use the presence of a ring to determine the band, regardless if automatic answer is selected. In private line mode, the modem will be in the originate band.</p> <p><b>%O1</b> Commands the modem to answer calls in the answer band in either switched network or private line mode.</p> <p><b>%O2</b> Commands the modem to answer calls in the originate band in either switched network or private line mode.</p>
<b>P</b>	Dialing type	Instructs the modem to use pulse dialing. The command may be used alone or as part of a dial string. When <b>P</b> is used alone, it makes pulse dialing the modem's default dialing method. When <b>P</b> is used in a dial string, it acts as a modifier and affects only the dialing of that string. Pulse dialing is blocked by some country code configurations.
<b>&amp;Pn</b>	Private line handshake mode	<p>Controls the selection of the private line handshake mode.</p> <p><b>&amp;P0</b> Selects V.34 only (28.8 - 2400)</p> <p><b>&amp;P1</b> Selects V.32 bis only (14.4 - 4800)</p> <p><b>&amp;P2</b> Selects V.32 only (9600 and 4800)</p> <p><b>&amp;P3</b> Selects IUT-T 212 (1200)</p> <p><b>&amp;P4</b> Selects IUT-T 103 (300)</p>
<b>%Pn=nnn</b>	Store password	Stores or removes the passwords in the modem's 10 memory cells, where $n = 0 - 9$ and $nnn =$ a password of up to 10 characters. To disable or clear the cell password, enter <b>%P</b> .
<b>\Pn</b>	Parity type	<p>Sets up what parity to use in data mode for front ends that do not send AT commands.</p> <p><b>\P0</b> Even parity</p> <p><b>\P1</b> Space parity</p> <p><b>\P2</b> Odd parity</p> <p><b>\P3</b> Mark parity</p> <p><b>\P4</b> Automatic parity; last AT (default)</p>
<b>:Pn</b>	Switched network transmit type	<p>Selects permissive or programmable mode for switched network operation.</p> <p><b>:P0</b> Selects permissive mode.</p> <p><b>:P1</b> Selects programmable mode.</p>
<b>*Pn</b>	Remote configuration security password	Defines the remote configuration security password, where $n =$ a cell password of 1 to 11 characters. To disable or clear the password, enter <b>*P</b> .
<b>Qn</b>	Response mode	<p>Controls the transmission of result codes.</p> <p><b>Q0</b> Requests non-quiet mode: result codes are transmitted to the DTE as appropriate.</p> <p><b>Q1</b> Requests quiet mode: modem does not send any result codes to the DTE.</p> <p><b>Q2</b> Disables Call Progress Monitor responses in answer mode only. Modem enters this mode on detection of ring signal.</p>

%Qn	Retrain on poor signal quality	Controls retrain initiation.
		%Q0 Disables retrain initiation.
		%Q1 Modem will try up to 3 consecutive retrains upon detection of poor signal quality. If not successful, the modem will disconnect the line.
		%Q2 Modem will retrain on poor signal quality until signal quality is OK.
\Qn	Modem-to-DTE flow control	Selects the type of data mode flow control used on the DTE port.
		\Q0 Disables all flow control.
		\Q1 Enables XON/XOFF signaling between modem and DTE.
		\Q2 Enables the modem to flow control the DTE via CTS.
		\Q3 Operates the same as the \Q2 option, and also allows the DTE to flow control the modem via RTS as a ready to receive signal.
		\Q4 Allows the modem to XON/XOFF the DTE yet ignore these signals when sent by the DTE (unidirectional flow control).
		\Q5 Allows the modem to flow control the DTE by almost stopping the transmit clock (internal transmit timing must be selected). Used with synchronous data compression.
&Rn	CTS operation	Defines the functionality of the Request to Send and Clear to Send EIA interchange circuits. V.13 and flow control options override &R settings for CTS
		&R0 Causes CTS to follow RTS with an interjected delay specified in S-Register 26 when in synchronous mode. In asynchronous command mode, CTS will be On. Upon reaching asynchronous data mode, CTS will follow the applicable ITU-T specification for the modulation chosen during handshake.
		&R1 Causes CTS to follow the applicable ITU-T specification in data mode (in synchronous modes, CTS will not follow RTS). In command mode, CTS will be On.
		&R2 Causes CTS to follow the applicable ITU-T specification. During test modes, CTS will follow V.54 conventions. CTS does not follow RTS in data modes. CTS will go Off after the call is dropped.
		&R3 Forces CTS On in all modes of operation (RTS is ignored).
%Rn	Call Progress Monitor message response speed	Controls the rate at which Call Progress Monitor (CPM) responses are sent to the DTE when the modem is optioned for \T0.
		%R0 Auto speed      %R1 last AT speed      %R2 300 bps
		%R3 1200 bps      %R4 2400 bps      %R5 4800 bps
		%R6 7200 bps      %R7 9600 bps      %R8 12.0 kbps
		%R9 14.4 kbps      %R10 16.8 kbps      %R11 19.2 kbps
		%R12 21.6 kbps      %R13 24.0 kbps      %R14 26.4 kbps
		%R15 28.8 kbps      %R16 31.2 kbps      %R17 33.6 kbps
		%R18 38.4 kbps      %R19 57.6 kbps      %R20 76.8 kbps
		%R21 115.2 kbps      %R22 128.0 kbps      %R23 32.0 kbps
		%R24 48.0 kbps      %R25 56.0 kbps      %R26 64.0 kbps
		%R27 72.0 kbps      %R28 96.0 kbps      %R29 112.0 kbps

<b>*R<i>n</i></b>	Remote configuration write access	Controls remote configuration write access. Refer also to the Remote Configuration feature description.
	<b>*R0</b>	Enables write access (read/write).
	<b>*R1</b>	Disables write access (read only).
<b>\R<i>n</i></b>	Asymmetrical DCE Rates	Enables or disables asymmetrical DCE rates.
	<b>\R0</b>	Disables asymmetrical rates. The transmit and receive DCE rate will be the same..
	<b>\R1</b>	Enables asymmetrical rates. BUFFERED ASYNCHRONOUS MODES ONLY: The transmit and receive DCE rates may be negotiated for different rates based on the line conditions. The modems receiver will select the remote modems transmit rate. For more information, refer to <a href="#">AT Command Details</a> .
<b>S<i>n</i></b>	S-Registers	Controls the S-Registers which store values for functions that are not often changed, (i.e., timers or counters), and the ASCII values of control characters. For more information, refer to <a href="#">AT Command Details</a> .
	<b>S<i>n</i>?</b>	Views the value stored in Register <i>n</i> .
	<b>S<i>n</i>=<i>x</i></b>	Changes an S-Register, where <i>n</i> is the Register and <i>x</i> is the new value.
	Automatic Answer <b>S0</b>	Determines the number of rings detected (1 - 255) before answering a call. If the value is 0, automatic answer is disabled. There is a default value is 2 rings.
	Ring Counter <b>S1</b>	Counts incoming rings detected. Counter is cleared after 8 seconds of ring silence in Idle mode. Counter cannot be cleared in data mode.
	Esc Code character <b>S2</b>	Holds the ASCII equivalent (0 -127) of the Escape Code character. Any value greater than 127 disables the Escape code function. The default is 43 (ASCII <b>+</b> ).
	Carr Return character <b>S3</b>	Holds the ASCII equivalent (0-127) of the Carriage Return character. The default is 13 (ASCII <b>CR</b> ).
	Line Feed character <b>S4</b>	Holds the ASCII equivalent (0-127) of the Line Feed character. The default is 10 (<lf>).
	Backspace character <b>S5</b>	Holds the ASCII equivalent (0-127) of the Backspace character. The default is 08 (ASCII <b>BS</b> ).
	Dialtone wait <b>S6</b>	Stores how many seconds the modem will wait for a dial tone before it starts dialing (0 to 255) The default is 2 seconds. This register is only active only with blind dialing ( <b>X0</b> , <b>X1</b> , or <b>X3</b> ).
	Carrier wait <b>S7</b>	Stores and determines how many seconds (1-60 sec) the modem will wait for carrier detection after dialing has been completed. The default is 60 seconds. Used for the dial command modifiers <b>W</b> (wait for dial tone before dialing) and <b>@</b> (wait for quiet answer before dialing). Sets the number of seconds the modem will wait for ringback when originating a call. This condition only occurs when using extended result code options <b>X3</b> or <b>X4</b> .
	Dial pause <b>S8</b>	Stores and determines how many seconds of pause will occur (0-255) when either of the pause dialing modifiers is used ( <b>,</b> or <b>&lt;</b> ). The default is 2 seconds.
	Carrier presence <b>S9</b>	Stores and determines how many tenths of a second (1 to 255) the carrier signal must be present following a carrier loss before the modem will turn on the EIA DCD signal to the DTE. This is called loss of carrier re-acquire debounce time. The default is 6 (0.6 second).



<i>S<sub>n</sub></i>	S-Registers (Continued)	Controls the S-Registers which store values for functions that are not often changed.
	Carrier loss <b>S10</b>	Stores and determines how many tenths of a second (1 to 254) the remote carrier signal must be lost before the local modem disconnects. The delay permits the carrier to disappear momentarily without causing the modem to hang up. A value of 255 disables disconnect.  The modem will recognize a carrier after the interval specified in <b>S9</b> . Therefore, if the value of <b>S10</b> is less than the value of <b>S9</b> , even a momentary loss of carrier will cause a disconnect. When the modem is in half-duplex asynchronous mode, the value stored in <b>S10</b> is ignored.
	S-Registers (continued)	Controls the S-Registers which store values for functions that are not often changed.
	Esc code guard <b>S12</b>	Determines how many 50ths of a second (1-255) the modem will use to recognize a valid escape sequence in the data stream. A sequence of three consecutive escape code characters ( <b>xxx</b> ) must occur within the specified interval to be detected by the modem. Once detected, the modem will switch from data mode to command mode. The default interval is 50 (1.00 second).
	Test mode <b>S18</b>	Determines how many 10-second intervals (0-60) must occur before an automatically timed test will run. A value of 0 allows no timeout - tests run until ended manually. The default is 0.
	DTR delay <b>S25</b>	When the modem is configured for asynchronous Operating Mode ( <b>&amp;M0</b> ), this value sets the delay for DTR in hundredths of a second (0 to 255). This is the interval used to debounce the DTR signal. The default is 5 (0.05 second).  When the modem is configured for synchronous Operating Mode ( <b>&amp;M1</b> ) and an asynchronous Command Format ( <b>%V0</b> or <b>%V1</b> ), this value is used to initially set the interval (0-255 seconds) for the operator to switch the EIA cable from asynchronous to synchronous equipment. The default is 5 seconds. After the whole-second timer expires, the register is then used to debounce the DTR signal, as above. The same number, stored in the register, is applied to both the whole-second and hundredth-of-a-second counts.
	RTS-to-CTS delay <b>S26</b>	Stores and determines how many milliseconds of delay (0-255) there will be between RTS and CTS. The default value is 0.
	Hang-up delay <b>S38</b>	Stores and determines the maximum delay in seconds (0-255) between a command to the modem to hang up and the disconnect operation. With a value between 0 and 254, the modem will wait up to that number of seconds for the remote modem to acknowledge receipt of all data buffers before hanging up. With a value of 255, the modem does not time-out, and continues to attempt to deliver data in the buffers until the connection is lost, or the data is delivered. The default is 20.  If the modem is configured to follow the DTR signal, an On-to-Off transition acts as a command to hang up. This register is useful for error-control and speed-buffering communications to ensure that data in the modem buffers is sent before the connection is terminated. If all data is transmitted prior to the timeout, the response to the <b>H0</b> command will be <b>OK</b> . If the timeout occurs before all data can be sent, the <b>NO CARRIER (3)</b> result code will be sent, indicating data has been lost.
	Priv line down <b>S40</b>	Stores and determines how many minutes (1-255) the modem will continue private line retrains before it attempts a switched network connection. A value of 0 disables the timer. Refer also to the Auto Dial Restoral feature description.
	Priv line lookback <b>S41</b>	Stores and determines how many 10-minute intervals (1-255) the modem will operate in switched network mode before it automatically attempts to return to private line mode. A value of 0 disables the timer and prevents the modem from automatically returning to the private line. Refer also to the Auto Dial Restoral feature description.
Call failure OOS <b>S42</b>	Only enabled in the modem by special arrangement between the customer and GDC. Sets how many consecutive failed calls (3-15) must occur before the modem will take itself out of service by presenting a busy signal on the telephone line.	



<b>S<sub>n</sub></b>	S-Registers (continued)	Controls the S-Registers which store values for functions that are not often changed.
	Retransmit counter <b>S70</b>	Stores and determines how many times (0-255) the modem will retransmit any one frame when noise is disrupting the reception of a frame and causing data errors. The modem hangs up after it has retransmitted up to the counter limit. The default is 100.  Use higher limits only when telephone lines are extremely noisy. In such conditions, although the connection delay may be undesirable, the modem will not hang up prematurely.
	Transmit level <b>S100</b>	Only configurable in those countries, such as the United States, that do not limit transmit level selections When you issue the command <b>S100?</b> the value displayed in this register is the transmit level configured in the modem.
<b>S\$</b>	S Register Help	Displays the S-Register Help Menu
<b>&amp;S<sub>n</sub></b>	DSR operation	Controls how the Data Set Ready EIA interchange circuit will operate. The <b>%Dn</b> command overrides the functionality of this command during any <b>ANALOOP</b> test.
	<b>&amp;S0</b>	Selects DSR to remain On and glitch Off for disconnect.
	<b>&amp;S1</b>	Causes DSR to be real (per ITU-T).
	<b>&amp;S2</b>	Selects DSR to follow carrier detect.
	<b>&amp;S3</b>	Selects DSR forced On in all modes.
<b>%S<sub>n</sub></b>	Password operation	Selects what type of password security the modem will enforce. Refer to <a href="#">Password Security Overview</a> for detailed information on combining security commands/options.
	<b>%S0</b>	Disables password security.
	<b>%S1</b>	Enables SteadFast security in the modem. During the handshake, the originate GDC modem transmits its cell 0 password; the answer GDC modem attempts a match with its cell 0 password.
	<b>%S2</b>	Enables Online Security in the modem. The answer modem prompts the remote for a cell password and attempts a match with passwords in cells 0 - 9.  If RADIUS Security is used, this command enables RADIUS. The passwords are stored in the RADIUS server. Refer to the SCM Manual, Appendix B for details.  For any modem function that uses %S2, it is strongly recommended to option the modem for <b>S2=128</b> .
	<b>%S3</b>	Enables both SteadFast and Online Security.
	<b>%S4</b>	Enables SteadFast Security with mandatory callback. Pass-through security is disabled.
	<b>%S6</b>	Enables Online Security with mandatory call-back.
	<b>%S7</b>	Enables SteadFast Security and Online Security with mandatory call-back.
<b>T</b>	Dialing type	Instructs the modem to use tone dialing as its selected dialing method. When the <b>T</b> is used alone, it sets the modem default to tone dialing. When the <b>T</b> command is used in a dial string, it acts as a modifier and affects only the dialing of that string.

<b>&amp;Tn</b>	Test mode	Controls the soft operation of test modes. The self-test pattern for speeds of 1200 and 2400 bps is made up of alternate ones and zeros; the 511 pattern is generated for all other speeds. Remote digital loopback and self-tests are not operational when the modems are passing data at 300 bps. All tests operate for the amount of time specified in <b>S18</b> ; pending tests such as <b>DL</b> are not allowed.				
	<b>&amp;T0</b>	Clears any active test and resumes normal data set operation.				
	<b>&amp;T1</b>	Initiates a soft ANALOOP test mode that directs all local data through the transmitter and receiver of the modem. Type <b>+++</b> followed by <b>&amp;T0</b> to terminate this test.				
	<b>&amp;T3</b>	Initiates a soft Digital Loop test mode that directs all received data from the remote modem to be looped back to the transmit data. This will echo on the remote DTE. Any data sent by the remote DTE is returned.				
	<b>&amp;T4</b>	Instructs the modem to accept the in-band request to initiate a remote digital loopback.				
	<b>&amp;T5</b>	Instructs the modem to ignore the in-band request to initiate a remote digital loopback.				
	<b>&amp;T6</b>	Instructs the modem to transmit the in-band request to establish a remote digital loopback with the far modem.				
	<b>&amp;T7</b>	Instructs the modem to transmit the in-band request to establish a remote digital loopback with the far modem, and to run the self-test pattern generator.				
	<b>&amp;T8</b>	Instructs the modem to enter the ANALOOP test mode, and to run the self-test pattern generator.				
	<b>&amp;T9</b>	Instructs the modem to send a self-test pattern to the remote modem while checking the receive data for the same test pattern and checking for errors.				
\Tn	DTE speed	Controls the DTE speed, in conjunction with the switched network handshake mode command ( <b>&amp;Hn</b> ). This command requires several factors to consider. Refer to <a href="#">Special Considerations for \Tn Command</a> .				
	<b>\T0</b>	Auto speed	<b>\T1</b>	last AT speed	<b>\T2</b>	300 bps
	<b>\T3</b>	1200 bps	<b>\T4</b>	2400 bps	<b>\T5</b>	4800 bps
	<b>\T6</b>	7200 bps	<b>\T7</b>	9600 bps	<b>\T8</b>	12.0 kbps
	<b>\T9</b>	14.4 kbps	<b>\T10</b>	16.8 kbps	<b>\T11</b>	19.2 kbps
	<b>\T12</b>	21.6 kbps	<b>\T13</b>	24.0 kbps	<b>\T14</b>	26.4 kbps
	<b>\T15</b>	28.8 kbps	<b>\T16</b>	31.2 kbps	<b>\T17</b>	33.6 kbps
	<b>\T18</b>	38.4 kbps	<b>\T19</b>	57.6 kbps	<b>\T20</b>	76.8 kbps
	<b>\T21</b>	115.2 kbps	<b>\T22</b>	128.0 kbps	<b>\T23</b>	32.0 kbps
	<b>\T24</b>	64.0 kbps	<b>\T25</b>	72.0 kbps	<b>\T26</b>	96.0 kbps
	<b>\T27</b>	72.0 kbps	<b>\T28</b>	96.0 kbps	<b>\T29</b>	112.0 kbps
	<b>:Tn</b>	Private line transmit level	Configures the transmit level of the modem for private line operation (0 dBm thru -15 dBm) in 1 dBm increments. The default is -9 dBm. The range may be limited according to country code. Use this command when private line operation for the transmit levels of the modems are too low or too high, causing an unreliable, error-filled connection.			
		<b>%Tn</b>	Inactivity timer	Sets a timer in minutes (1-255) for disconnecting the line on idle TX or RX data. A value of 0 disables the timer (default).		
<b>&amp;Un</b>	Trellis coding	Controls Trellis coding when the modem is operating in V.32 mode at 9600 bps.				
	<b>&amp;U0</b>	Enables Trellis coding.				
	<b>&amp;U1</b>	Disables Trellis coding.				

<b>Vn</b>	Result code type	Controls the transmission of result codes. Refer to the <code>\Vn</code> command for a list of all possible result codes and refer to <a href="#">\Vn Connect Messages Details</a> for message descriptions.
		<b>V0</b> Selects non-verbal (numeric equivalent) result codes to be transmitted. The connect message is the VF line speed.
		<b>V1</b> Selects verbal result codes. The connect message is the DTE speed, except for V.14 mode.
<b>&amp;V</b>	View stored phone number	Displays the ten stored telephone number cells.
<b>%Vn</b>	Command format	Determines the command format. When the modem is configured in synchronous data mode ( <b>&amp;M1</b> ), the <b>%V0</b> or <b>%V1</b> commands will be affected. Refer to <b>S25</b> for details.
		<b>%V0</b> AT command set
		<b>%V1</b> V.25 bis asynchronous command set
		<b>%V2</b> V.25 bis High Level Data Link Control (HDLC) command set
		<b>%V3</b> V.25 bis IBM Binary Synchronous Communication (BSC) command set
		<b>%V4</b> None
<b>\Vn</b>	Connect message type	Determines the type of connect message sent to the DTE when a data link is established. Refer to <a href="#">\Vn Connect Messages Details</a> as noted below for message details.
		<b>\V0</b> Options the modem to send the standard GDC Connect message upon reaching fata mode plu V.42 messages after the link negotiation. The connect message displays VF line speed. Refer to <a href="#">Table 4-2</a> and <a href="#">Table 4-3</a> for a description of <b>\V0</b> connect messages.
		<b>\V1</b> Options the modem to delay sending the Connect message until an error correction link has been established. The Connect message indicates DTE speed. If a V.14 connection was established, the Connect message will indicate V Fspeed. Refer to <a href="#">Table 4-3</a> and <a href="#">Table 4-4</a> for a description of <b>\V1</b> connect messages.
		<b>\V2</b> Options the modem to delay sending the Connect message until an error correction link has been established. The Connect message indicates DTE speed. If a V.42 error corrected link has been established, <b>/REL</b> will be included at the end of the message. Refer to <a href="#">Table 4-5</a> for a description of <b>\V2</b> connect messages.
		<b>\V3</b> Sends only the Connect message after the link negotiation. The Connect message indicates VF rate for V.13 and V.14 connections, and indicates the DTE rate for all other connections.
		<b>\V4</b> Displays the transmit and receive DCE rate as <b>CONNECT rrrrr tttt</b> , where <i>rrrrr</i> is receive speed, and <i>tttt</i> is transmit speed. (Numeric result codes in asymmetrical mode indicate the receive speed.)
		<b>&amp;Wn</b>
<b>*Wn</b>	Remote config	Controls remote configuration.
		<b>*W0</b> Disables remote configuration.
		<b>*W1</b> Enables remote configuration.

<b>X<sub>n</sub></b>	Call Progress Monitor	Controls which Call Progress Monitor (CPM) signals are monitored and reported to the local DTE. Country configuration definitions can restrict the storage function.
	<b>X0</b>	Forces blind dialing, disables all CPM, and only the CONNECT message is sent for all established links.
	<b>X1</b>	Forces blind dialing, disables all CPM, and the CONNECT message includes the connected speed.
	<b>X2</b>	Enables CPM for pre-dial signals (dialtone) only, and the CONNECT message includes connected speed.
	<b>X3</b>	Forces blind dialing, enables CPM for post-dial signals only (busy, unobtainable number, etc.), and the CONNECT message includes connected speed.
	<b>X4</b>	Enables CPM response codes and monitoring, and the CONNECT message includes connected speed.
	<b>X5</b>	Enables all CPM response codes and monitoring, including ringback detection, CONNECT message includes connected speed.
<b>&amp;X<sub>n</sub></b>	Transmit clock source	Selects the clock source when the modem operates in synchronous Data Mode
	<b>&amp;X0</b>	Directs the modem to use its internally generated clock source.
	<b>&amp;X1</b>	Selects the DTE clock as a source for the modem.
	<b>&amp;X2</b>	Selects the modem's RECEIVER derived timing clock to be used in the transmitter.
<b>*X<sub>n</sub></b>	Remote config exit	Controls remote configuration exit. Before disconnecting, you must use the <b>&amp;Z<sub>n</sub></b> and <b>&amp;Y<sub>n</sub></b> command to save Power ON defaults.
	<b>*X0</b>	Terminates the session without saving changes.
	<b>*X1</b>	Terminates the session and saves changes.
<b>Y<sub>n</sub></b>	Long space disconnect	Controls the long space disconnect option. When the option is enabled, any disconnect request (e.g., <b>ATH0</b> , loss of DTR or DCD) will cause the modem to transmit 4 seconds of continuous space ( <b>BREAK</b> ). A modem with long space disconnect enabled will hang up when it receives more than 1.5 seconds of continuous space ( <b>BREAK</b> ) while on-line.
	<b>Y0</b>	Disables long space disconnect.
	<b>Y1</b>	Enables long space disconnect.
<b>&amp;Y<sub>n</sub></b>	Power-up user profile	Determines which of the stored user configuration profiles ( <b>&amp;W<sub>n</sub></b> ) will be activated at modem power-up, where <i>n</i> is memory cell location <b>0 - 3</b> .
<b>Z<sub>n</sub></b>	Load user profile	Re-initializes the modem with one of the stored user configuration profiles ( <b>&amp;W<sub>n</sub></b> ), where <i>n</i> is memory cell location <b>0 - 3</b> .
<b>&amp;Z<sub>n</sub>= nnn</b>	Store a phone number	Stores a telephone number, where <i>n</i> is one of the ten memory cells ( <b>0 - 9</b> ), and <i>nnn</i> is the dial string which includes the phone number. The dial string can have up to thirty-six characters, including any valid commands.
<b>%Z<sub>n</sub></b>	DTR dialing	Controls the Off-to-On DTR transition options for DTR dialing. The <b>&amp;D0</b> command overrides this option
	<b>%Z0</b>	Modem will ignore the Off-to-On transition of DTR.
	<b>%Z1=x</b>	Modem will dial on transition when a DTR Off-to-On transition occurs and DTR remains On. In the command, <i>x</i> is the memory cell that contains the number to be dialed. The specified cell must be programmed with a valid phone number prior to this operation. When no cell number is provided, the default is Cell <b>0</b> .
	<b>%Z2</b>	Modem will go off-hook and try to handshake on an Off-to-On transition of DTR.
	<b>%Z3=x</b>	Same as <b>%Z1=x</b> except the modem will redial on transition as well as when the connection is broken while the DTR remains On.

## AT Command Details

This section provides special considerations and detailed lookup tables for certain AT commands.

### Special Considerations for \Tn Command

The `\Tn` command controls the DTE speed, in conjunction with the switched network handshake mode command (`&Hn`). There are several factors to consider when setting this value:

- An automatic handshake mode (e.g., V.32 bis auto `&H1`, V.32 auto `&H4`, V.22 bis only `&H6`) takes precedence over the `\Tn` selection. The modem will try for the highest VF speed common to the two commands.
- For 1200 bps V.22 operation, select `&H7`. Since `&H6` is an auto mode, setting the DTE to 1200 bps with the `\T3` command will not force the connection to 1200 bps.
- When the modem is optioned for an automatic handshake mode and direct V.14 asynchronous mode (`\N1`), it sends a connect message to the DTE at the selected `\Tn` speed. In order to pass data, the user must change the DTE's speed to match the displayed connect speed.
- When the modem is optioned for speed buffering (`\N0`) or an error correcting protocol (`\N2` through `\N5`), the `\Tn` command alone selects the DTE speed. The `&Hn` command selects the handshake mode.
- When the modem is optioned either for a fixed handshake mode and direct mode (`\N1`) or for synchronous data mode (`&M1`), the `\Tn` command not only selects the DTE speed, but also forces the VF speed to match it. If this speed is not available, the modem drops the call. This does not apply to V.22 bis only, which handshakes at the highest VF speed.)
- When using the modem in direct mode (`\N1`), if the desired connect speed is known, set the speed to match, using the `\Tn` command. Set the DTE to the same speed and then `AT` the modem so that it will know at what speed to send messages.

### Special Considerations for Asymmetrical DCE Rates

- Asymmetrical rates are disabled by the AT commands: `\N1`, `\N6` and `%M1`
- The `&G` command limits only the rate of the receiver in `\R1` mode.
- The `\V0` and `|V2` command formats remain the same reporting the receivers rate.
- The `\V1` and `\V3` commands report the DTE rate. The `\V4` commands reports the Asymmetrical rate.
- Front Panels report the Receive Rate (single rackmount).

**&Fn - Fixed Configuration Details****Table 4-1** Fixed Configuration Profile Settings

AT Command (Option)		Fixed Profile 0	Fixed Profile 1	Fixed Profile 2	Fixed Profile 3
<b>%O</b>	Answer mode	Ans. mode if ringing	Ans. mode if ringing	Ans. mode if ringing	Ans. mode if ringing
<b>\N</b>	Asynchronous protocol	Auto-reliable	Auto-reliable	Auto-reliable	Auto-reliable
<b>&amp;B</b>	Auto Dial Restoral	Disable	Disable	Disable	Disable
<b>%A</b>	Auto-reliable fallback char.	"CR	""CR	""CR	""CR"
<b>&amp;A</b>	Automatic fallforward/fallback	Disable	Disable	Disable	Disable
<b>\K</b>	Break character handling	See <b>\K5</b>	See <b>\K5</b>	See <b>\K5</b>	See <b>\K5</b>
<b>X</b>	Call Progress Monitor	Ext. results/full CPM	Ext. results/full CPM	Ext. results/full CPM	Ext. results/full CPM
<b>M</b>	Cellular Power Adjust	Disabled )M0	Disabled )M0	Disabled )M0	Disabled )M0
<b>%K</b>	Character abort	2-sec. delay	Disable	2-sec. delay	Disable
<b>\B</b>	Character length	See <b>\B2</b>	See <b>\B2</b>	See <b>\B2</b>	See <b>\B2</b>
<b>\V</b>	Connect message type	See <b>\V3</b>	See <b>\V3</b>	See <b>\V3</b>	See <b>\V3</b>
<b>N</b>	Country code	USA	USA	USA	USA
<b>%R</b>	CPM message response speed	Autobaud speed	Autobaud speed	Autobaud speed	Autobaud speed
<b>&amp;R</b>	CTS operation	See <b>&amp;R1</b>	See <b>&amp;R2</b>	See <b>&amp;R2</b>	See <b>&amp;R2</b>
<b>%C</b>	Data compression	Enable both ways	Enable both ways	Enable both ways	Enable both ways
<b>&amp;C</b>	DCD operation	Real mode	Real mode	Real mode	Real mode
<b>&amp;G</b>	DCE rate limit	33.6 kbps max	33.6 kbps max	33.6 kbps max	33.6 kbps max
<b>P or T</b>	Dialing type	Tone ( <b>T</b> )	Tone ( <b>T</b> )	Tone ( <b>T</b> )	Tone ( <b>T</b> )
<b>&amp;S</b>	DSR operation	Normal	Normal	Normal	Normal
<b>%D</b>	DSR operation in test mode	Forced Off	Forced Off	Forced Off	Forced Off
<b>%E</b>	DTE interface-controlled tests	Disable	Disable	Disable	Disable
<b>\T</b>	DTE speed	Last AT speed	Autobaud	Last AT speed	Autobaud
<b>%Z</b>	DTR dialing	Disable	Disable	Disable	Disable
<b>&amp;D</b>	DTR On-to-Off transition	Ignore	Go on-hook	Go on-hook	Go on-hook
<b>&amp;I</b>	Front panel lockout	Enable	Enable	Enable	Enable
<b>%H</b>	Heart Beat Timer	Disabled	Disabled	Disabled	Disabled
<b>%T</b>	Inactivity Timer	Disabled	Disabled	Disabled	Disabled
<b>@M</b>	Initial Power Level Setting	-26 dBm	-26 dBm	-26 dBm	-26 dBm
<b>E</b>	Local DTE echo	Enable	Enable	Disable	Disable

(Sheet 1 of 3)

**Table 4-1** Fixed Configuration Profile Settings (Continued)

AT Command (Option)		Fixed Profile 0	Fixed Profile 1	Fixed Profile 2	Fixed Profile 3
<b>Y</b>	Long space disconnect	On	On	On	On
<b>%B</b>	Make busy	Disable	Disable	Disable	Disable
<b>-M</b>	MNP 10	Disabled	Disabled	Disabled	Disabled
<b>*H</b>	MNP Link Negotiation Speed	Highest Rate	Highest Rate	Highest Rate	Highest Rate
<b>\Q</b>	Modem-to-DTE flow control	Use CTS	Use CTS	Use CTS	Use CTS
<b>\G</b>	Modem-to-modem flow control	Disable	Disable	Disable	Disable
<b>&amp;L</b>	Network type	Switched network	Switched network	Two-wire private line	Two-wire private line
<b>&amp;M</b>	Operating mode	Async data	Sync data	Async data	Sync data
<b>\A</b>	Overspeed correction	Nominal	Nominal	Nominal	Nominal
<b>\P</b>	Parity type	Auto	Auto	Auto	Auto
<b>\C</b>	Pre-link data buffer	Refer to <b>\C2</b> command			
<b>&amp;P</b>	Private line handshake mode	V.34 only	V.34 only	V.34 only	V.34 only
<b>:T</b>	Private line transmit level	-9 dBm	-9 dBm	-9 dBm	-9 dBm
<b>&amp;T4 , &amp;T5</b>	RDL options	Disable RDL	Disable RDL	Disable RDL	Disable RDL
<b>Q</b>	Response mode	Result codes	Result Codes	Quiet	Quiet
<b>v</b>	Result code type	Verbal	Verbal	Verbal	Verbal
<b>%Q</b>	Retrain on poor signal quality	Until SQ is good	Until SQ is good	Until SQ is good	Until SQ is good
<b>&amp;Sn</b>	DSR operation	Normal	Normal	Normal	Normal
<b>Sn</b>	S-Registers	Decimal (ASCII)	Decimal (ASCII)	Decimal (ASCII)	Decimal (ASCII)
<b>0</b>	Rings to answer on	1	1	1	1
<b>2</b>	Escape code character	43 (+)	43 (+)	43 (+)	43 (+)
<b>3</b>	Carriage return character	13 (CR)	13 (CR)	13 (CR)	13 (CR)
<b>4</b>	Line feed character	10 (LF)	10 (LF)	10 (LF)	10 (LF)
<b>Sn</b>	S-Registers (Continued)	Decimal (ASCII)	Decimal (ASCII)	Decimal (ASCII)	Decimal (ASCII)
<b>5</b>	Back space character	08 (BS)	08 (BS)	08 (BS)	08 (BS)
<b>6</b>	Wait for dial tone	2 sec.	2 sec.	2 sec.	2 sec.
<b>7</b>	Wait for carrier for <b>W</b> and <b>@</b>	60 sec.	60 sec.	60 sec.	60 sec.
<b>8</b>	Pause time for <b>,</b> or <b>&lt;</b>	2 sec.	2 sec.	2 sec.	2 sec.
<b>9</b>	Carrier detect response time	0.6 sec.	0.6 sec.	0.6 sec.	0.6 sec.

(Sheet 2 of 3)

**Table 4-1** Fixed Configuration Profile Settings (Continued)

AT Command (Option)	Fixed Profile 0	Fixed Profile 1	Fixed Profile 2	Fixed Profile 3
<b>10</b> Loss of carrier to hang up delay	1.4 sec.	1.4 sec.	1.4 sec.	1.4 sec.
<b>Sn</b> S-Registers (Continued)	Decimal (ASCII)	Decimal (ASCII)	Decimal (ASCII)	Decimal (ASCII)
<b>12</b> Escape sequence guard time	1 sec.	1 sec.	1 sec.	1 sec.
<b>18</b> Modem test timer	0 sec.	0 sec.	0 sec.	0 sec.
<b>25</b> -Delay to DTR - all modes -%V0 or %V1 with sync data mode	0.05 sec. 5 sec.	0.05 sec. 5 sec.	0.05 sec. 5 sec.	0.05 sec. 5 sec.
<b>26</b> RTS/CTS delay	0 sec.	0 sec.	0 sec.	0 sec.
<b>38</b> Hang-up delay timer	20 sec.	20 sec.	20 sec.	20 sec.
<b>40</b> Private line down timer	1 min.	1 min.	1 min.	1 min.
<b>42</b> Call failures before modem make busy (special feature, implemented only by GDC at a point-of-sale.)	N/A	N/A	N/A	N/A
<b>41</b> Private line lookback timer	1 min.	1 min.	1 min.	1 min.
<b>70</b> Max. no. of re-transmissions	100	100	100	100
<b>&amp;E</b> Simulated controlled carrier	Enable both ways	Enable both ways	Enable both ways	Enable both ways
<b>%P</b> Store password	None	None	None	None
<b>&amp;H</b> Switched network handshake mode	V.34 auto	V.34 auto	V.34 auto	V.34 auto
<b>:P</b> Switched network transmit type	Permissive	Permissive	Permissive	Permissive
<b>\M</b> Synchronous protocol	Normal	Normal	Normal	Normal
<b>&amp;X</b> Transmit clock source	Internal	Internal	Internal	Internal
<b>&amp;U</b> Trellis coding	Enable	Enable	Enable	Enable
<b>&amp;Y</b> Power-up user configuration profile	User Profile 0	User Profile 0	User Profile 0	User Profile 0

(Sheet 3 of 3)



## \Vn Connect Messages Details

The following tables list the messages enabled by the `\Vn` command, including the meaning, the verbal text response and the numeric code response of each connect message. Verbal text responses are terminated by carriage return `<cr>` and line feed `<lf>`. Numeric code responses are terminated by carriage return `<cr>`.

**Table 4-2** \V0 Connect Message Descriptions

NUMERIC	MEANING	VERBAL RESPONSE
0	Command was successful	OK
4	Command failed	ERROR
1	Link established	CONNECT
2	Incoming ring detected	RING
24	Exchange cannot dial number	UN-OBTAINABLE NUMBER
3	Link dropped	NO CARRIER
6	Dial tone not present	NO DIALTONE
8	Remote not answering	NO ANSWER
7	Line busy	BUSY
1	Link established at 300	CONNECT
5	Link established at 1200	CONNECT 1200
10	Link established at 2400	CONNECT 2400
11	Link established at 4800	CONNECT 4800
15	Link established at 7200	CONNECT 7200
12	Link established at 9600	CONNECT 9600
16	Link established at 12000	CONNECT 12000
17	Link established at 14400	CONNECT 14400
18	Link established at 16800	CONNECT 16800
14	Link established at 19200	CONNECT 19200
19	Link established at 21600	CONNECT 21600
20	Link established at 24000	CONNECT 24000
21	Link established at 26400	CONNECT 26400
22	Link established at 28800	CONNECT 28800
23	Link established at 31200	CONNECT 31200
24	Link established at 33600	CONNECT 33600
44	Link established at 31200/REL	CONNECT 31200
45	Link established at 33600/REL	CONNECT 33600/REL
46	Link established at 38400/REL	CONNECT 38400/REL
47	Link established at 57600/REL	CONNECT 57600/REL
48	Link established at 76800/REL	CONNECT 76800/REL
49	Link established at 115200/REL	CONNECT 115200/REL
50	Link established at 128000/REL	CONNECT 128000/REL

**Table 4-3** \W0 and \W1 Connect Message Descriptions

NUMERIC	MEANING	VERBAL RESPONSE
70	No Protocol	PROTOCOL:NONE
77	V.42 Protocol	PROTOCOL:V.42
79	V.42 <i>bis</i> Protocol	PROTOCOL:V.42BIS
80	MNP Protocol	PROTOCOL:ALTERNATE
82	MNP Class 2	PROTOCOL:ALTERNATE,CLASS 2
24	MNP Class 2+4	PROTOCOL:ALTERNATE,CLASS 2 + CLASS 4
245	MNP Class 2+4+5	PROTOCOL:ALTERNATE,CLASS 2 CLASS 4 CLASS 5
83	MNP Class 3	PROTOCOL:ALTERNATE,CLASS 3
34	MNP Class 3+4	PROTOCOL:ALTERNATE,CLASS 3 CLASS 4
345	MNP Class 3+4+5	PROTOCOL:ALTERNATE,CLASS 3 CLASS 4 CLASS 5

**Table 4-4** \W1 Connect Message Descriptions

NUMERIC	MEANING	VERBAL RESPONSE
1	DTE Link at 300	CONNECT
5	DTE Link at 1200	CONNECT 1200
10	DTE Link at 2400	CONNECT 2400
11	DTE Link at 4800	CONNECT 4800
15	DTE Link at 7200	CONNECT 7200
12	DTE Link at 9600	CONNECT 9600
16	DTE Link at 12000	CONNECT 12000
17	DTE Link at 14400	CONNECT 14400
18	DTE Link at 16800	CONNECT 16800
14	DTE Link at 19200	CONNECT 19200
19	DTE Link at 21600	CONNECT 21600
20	DTE Link at 24000	CONNECT 24000
21	DTE Link at 26400	CONNECT 26400
22	DTE Link at 28800	CONNECT 28800
25	DTE Link at 38400	CONNECT 38400
26	DTE Link at 57600	CONNECT 57600
27	DTE Link at 76800	CONNECT 76800
28	DTE Link at 115200	CONNECT 115200
29	DTE Link at 128000	CONNECT 128000

**Table 4-5** \V2 Connect Message Descriptions

<b>Numeric</b>	<b>Meaning</b>	<b>Verbal Response</b>
0	Command was successful	OK
1	Link established	CONNECT
2	Incoming ring detected	RING
3	Link dropped	NO CARRIER
4	Command failed	ERROR
5	Link established at 1200	CONNECT 1200
6	Dial tone not present	NO DIALTONE
7	Line busy	BUSY
8	Remote not answering	NO ANSWER
10	Link established at 2400	CONNECT 2400
30	Reliable DTE Link at 300	CONNECT REL
31	Reliable DTE Link at 1200	CONNECT 1200/REL
32	Reliable DTE Link at 2400	CONNECT 2400/REL
33	Reliable DTE Link at 4800	CONNECT 4800/REL
34	Reliable DTE Link at 7200	CONNECT 7200/REL
35	Reliable DTE Link at 9600	CONNECT 9600/REL
36	Reliable DTE Link at 12000	CONNECT 12000/REL
37	Reliable DTE Link at 14400	CONNECT 14400/REL
38	Reliable DTE Link at 16800	CONNECT 16800/REL
39	Reliable DTE Link at 19200	CONNECT 19200/REL
40	Reliable DTE Link at 21600	CONNECT 21600/REL
41	Reliable DTE Link at 24000	CONNECT 24000/REL
42	Reliable DTE Link at 26400	CONNECT 26400/REL
43	Reliable DTE Link at 28800	CONNECT 28800/REL
44	Reliable DTE Link at 38400	CONNECT 38400/REL
45	Reliable DTE Link at 57600	CONNECT 57600/REL
46	Reliable DTE Link at 76800	CONNECT 76800/REL
47	Reliable DTE Link at 115200	CONNECT 115200/REL
48	Reliable DTE Link at 128000	CONNECT 128000/REL



# Chapter 5: V.25 bis Commands

---

## V.25 bis Command Overview

This chapter describes the operating procedures for the V.F 28.8 modem when using the ITU-T (formerly CCITT) V.25 bis compatible command protocol. Although the AT command set is the primary command set for configuring the modem, the modem provides an enhanced ITU-T V.25 bis command protocol that permits you to configure modem dial parameters and establish data communications. After configuring the modem using the AT command set, use the `%Vn` command to switch to the V.25 bis command set.

### V.25 bis Modes

The ITU-T V.25 bis protocol operates in one of two modes: 108.2 or 108.1. The modes are named for the two ITU-T designations for circuit 108 of the terminal interface:

- In 108.2 mode, the circuit is the **Data Terminal Ready** signal.
- In 108.1 mode, the circuit is the **Connect Data Set to Line** signal.

---

**Note** *Circuit 108 is pin 20 in a DB25 connector; in a 34-pin V.35 connector it is pin H.*

---

#### 108.2 Mode

The 108.2 operating mode supports convenient outbound calling to multiple locations. When the DTE instructs the modem to originate a call in 108.2 mode, it also specifies the number to be dialed. The DTE can either supply the number itself along with the command to dial, or identify which of the modem's memory cells contains the number to be dialed.

In 108.2 mode the modem supports an ITU-T V.25 bis compatible command set you can use from the DTE to interrogate and configure the modem and to control communication and test functions. This command set can configure operating parameters such as data rate, handshake mode, and synchronous timing source; as well as storage of phone numbers in the modem's memory cells.

In order for the V.25 bis command set to function, the modem must be operating in 108.2 mode and terminal interface circuit 108.2 **Data Terminal Ready** must be On. When circuit 108.2 is Off, the modem ignores the commands. Circuit 108.2 can be forced On while the modem is in asynchronous mode by using the AT command `&D0`.

#### 108.1 Mode

The 108.1 operating mode supports automatic outbound calling directed primarily to a single location. The DTE instructs the modem to originate a call by turning On circuit 108.1 **Connect Data Set to Line**. The modem then goes off-hook, dials the number stored in its memory cell 0, and attempts to establish communication.

The modem will disconnect from the line if it does not successfully handshake in the time specified in the abort timer selected by the AT command `S7=x` (default is 30 seconds). If you turn Off 108.1 while the modem is in the data mode, the modem will hang up and disconnect.

The ITU-T V.25 bis compatible command set is not available when the modem is operating in 108.1 mode. Storage of a telephone number in memory cell 0 must be performed either in 108.2 mode (using the PRN command), or by means of AT commands. Any number can be called in 108.1 mode by dialing manually and then turning On circuit 108.1 when answer tone is heard from the remote modem.

**Note** A full description of the procedures for the 108.2 and 108.1 modes are provided in this chapter, paragraph: [108.2 Mode Interface Specifications](#).

**Note** Synchronous V.25 bis Interface Specifications for synchronous dialing protocol are provided in this chapter, paragraph: [108.2 Mode Interface Specifications](#).

**Table 5-1** Legal Dialing Characters

Character	Description
0 1 2 3 4 5 6 7 8 or 9	Pulse and tone dial digits
#	Tone dial character
*	Tone dial character
P	Causes dialed numerals following P to be dialed using pulses. Used to select pulse dialing for compatibility with your telephone system. Pulse dialing is blocked by some country code configurations.
T	Causes dialed alphanumeric characters following T to be dialed using tones. Used to select tone dialing for compatibility with your telephone system.
, or <	Causes the modem to pause a specified interval (in seconds) before dialing the next digit of a telephone number (the 2 seconds default may be changed with the AT\$8=x command). Used when the telephone system requires a pause before it can accept the next digit of the telephone number being dialed.
! or &	Causes the modem to go on-hook (flash) momentarily. Used to command certain internal telephone systems (PBXs).
@	Causes the modem to wait <i>n</i> seconds for one or more rings followed by five seconds of silence before dialing the next digit of a telephone number (if <i>n</i> seconds expire before a ring is detected, the modem will abort dialing and return to the command mode). Used to dial a telephone system that does not provide dial tone. Silence, rather than dial tone, indicates that the telephone system is ready to accept telephone number dialing. ( <i>n</i> = the value selected in the abort timer.)
Ln	On dial failure, link to the telephone number stored in cell <i>n</i> ( <i>n</i> = 0 to 9).
W or :	Causes the modem to wait a specified length of time for dial tone before dialing the next digit of the telephone number. The length of time is specified by the AT\$7=x command. If this time expires before dial tone is detected, the modem will abort dialing and return to the command line.

## V.25 bis Command Responses

When entering commands, terminate each one with a line feed **LF** control character. The modem sends a response back to the terminal for each command. When an invalid command is entered, the modem sends an **INV** response back to the terminal with an explaining the invalid command. Most terminals display the responses to indicate each entered command's result, but responses will be ignored by communication software that enables a computer to emulate a terminal.

**Table 5-2** Explanation of Responses

Response	Description
CFI AB	Call failure indication: no carrier, call was aborted (time-out occurred or character was entered at keyboard).
CFI BF	Call failure indication: telephone number black list (which uses the 10 memory cells) is full. You cannot place any more calls until after a timeout, the memory cell is modified, or the modem is reset.
CFI DT	Call failure indication: dial tone was not detected (dial tone time-out occurred).
CFI DF	Call failure indication: telephone number delayed list (which uses the 10 memory cells) is full. Numbers which are redialed continuously without making a connection are added to the delayed list. They will be removed from the list after a timeout, when a connection is made, when the memory cell is modified, or when the modem is reset.
CFI ET	Call failure indication: remote modem is busy.
CFI UT	Call failure indication: unobtainable number tone was detected.
CNX	300 bps connection is established.
CNX 1200	1200 bps connection is established.
CNX 2400	2400 bps connection is established.
CNX 4800	4800 bps connection is established.
CNX 7200	7200 bps connection is established.
CNX 9600	9600 bps connection is established.
CNX 12000	12,000 bps connection is established.
CNX 14400	14,400 bps connection is established.
CNX 16800	16,800 bps connection is established.
CNX 19200	19,200 bps connection is established.
CNX 21600	21,600 bps connection is established.
CNX 24000	24,000 bps connection is established.
CNX 26400	26,400 bps connection is established.
CNX 28800	28,800 bps connection is established.
INC	Incoming call was detected. This response is generated only once for each incoming call.
INV	The modem cannot recognize the command and responds as follows:
	Command invoked: DIC                      Response: INC not received.
	Command invoked: PRS                      Response: Non-selectable option in user's country.
RNGBK	Ringback was detected by the originating modem.
VAL	Valid command was invoked.

## 108.2 Mode Interface Specifications

### Interface Connections

Physical connections between a DTE and a DCE may be either synchronous or asynchronous. The ITU-T V.25 bis 108.2 mode recommendations describe the exchange of commands and responses between the units using both types of operation. The V.F 28.8 supports command/response exchange in either mode. The following paragraphs describe the functional characteristics of the V.25 bis synchronous and asynchronous interfaces, as used in the V.F 28.8 modem.

**Table 5-3** Interface Connections

From DCE to DTE		From DTE to DCE	
104	RXD	103	TXD
106	CTS	105	RTS
107	DSR	108.2	DTR
125	Call Indicator/Ring Detector	113	TX Timing (synchronous only)
114	TX Timing (synchronous only)		
115	RX Timing (synchronous only)		

### Synchronous Bit-Oriented Operation

The V.F 28.8 supports both the bit-oriented and the byte-oriented modes of synchronous operation. In synchronous mode, the V.F 28.8 does not support 300 bps, nor will the modem handshake with an incoming call at 300 bps FSK. The modem uses the HDLC format in the bit-oriented synchronous mode (%V2 AT command). The structure of each message in this format is shown below. Note that the modem will not recognize the C or A fields unless verified as shown.

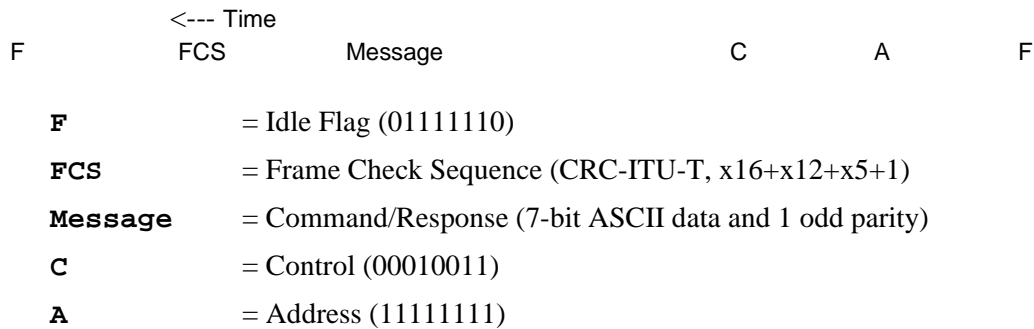



### Synchronous Byte-Oriented Operation

The modem uses the BISYNC (BSC) format in the byte-oriented synchronous mode (%V3 AT command). BCC is always transmitted in the modem's responses, but optionally included in the DTE commands. In this way, the modem conforms to BSC conventions without deviating from the ITU-T V.25 bis Recommendations. The structure of each message in this format is shown below.

	<--- Time				
BCC	ETX	Message	STX	SYN	SYN

<b>BCC</b>	= LRC Block Check Character for ASCII
<b>ETX</b>	= ASCII ETX Character (10000011)
<b>Message</b>	= Command/Response (7-bit ASCII data and 1 odd parity)
<b>STX</b>	= ASCII STX Character (00000010)
<b>SYN</b>	= ASCII SYN Character (00010110)

### Asynchronous Format

The structure of each message in the asynchronous mode (%V1 AT command) format is shown below:

	<--- Time		
OFF	LF	Message	OFF

<b>OFF</b>	= Interface idle
<b>Message</b>	= Command/Response (10-bit characters: 1 start, 7-bit ASCII data, 1 even parity, 1 stop)
<b>LF</b>	= ASCII Line Feed Character (00001010)

### Modem Test Modes

When optioned to operate in the synchronous V.25 *bis* mode, the V.F 28.8 supports the following test modes that can be initiated from the Front Panel:

- Analog Loopback
- Analog Loopback with Self-Test
- Digital Loopback
- Remote Digital Loopback
- Remote Digital Loopback with Self-Test
- End-to-End Self-Test

All tests may be terminated from the front panel switches, and the modem returns to off-line idle command state when DTR goes from On to Off. Pending tests can be cleared only from the front panel.

## Commanding the Modem

Descriptions of each V.25 *bis* 108.2 mode command appear on the following pages. Operating procedures for establishing and terminating data communications are explained following the command descriptions.

### V.25 *bis* Configuration Commands

#### NVW Write Option Settings to User Configuration Profile

NVW saves the current settings to a user configuration profile in the modem's non-volatile memory, with the exception of the Terminator Character option (which is set to its factory default, the line feed control-character). This command saves a set of option values that is activated when the modem is powered up. To invoke this command, type:

**NVW ; n <LF>** where *n* is the user configuration profile (0 to 3).

#### PRN Store Phone Number to Cell

PRN stores a telephone number in one of the modem's ten memory cells. Numbers stored by means of this command can be automatically dialed either by invoking the CRS command in 108.2 mode, or by turning On circuit 108.1 in 108.1 mode (108.1 dialing uses only the number stored in memory cell 0).

To store a number, type: **PRN n1 ; n2 <LF>** where *n1* is the memory cell (from 0 to 9) in which the number is to be stored, and *n2* is the phone number to be stored. *n2* may contain any legal dialing characters ([Table 5-1](#)).

#### PRS AA Automatic Answering

PRS AA controls the automatic answering function. When you enable automatic answering, you can specify the number of rings the modem will wait before it performs automatic answering. Default is 4 rings.

To enable automatic answering, type: **PRS AA ; n <LF>** where *n* is the number of rings (from 1 to 255) that the modem waits before automatically answering an incoming call.

To disable automatic answering, type: **PRS AA ; 0 <LF>**

#### PRS AT AT Command Set

PRS AT switches the modem from V.25 *bis* command set mode to AT command set mode.

To invoke this command, type: **PRS AT <LF>**

To return to V.25 *bis* command set mode, use the **AT%Vn** command.

**PRS CM    Connect Message Inhibit**

PRS CM controls the CNX yy connect message responses. The V.F 28.8 supports both the 1989 and the 1984 recommendations for V.25 *bis* connection procedures. The 1989 CCITT Blue Book recommends that when the modem transfers from command mode to data mode it should send a connect message of the form CNX yy, where yy identifies the connect speed (96 = 9600 bps, 48 = 4800 bps, 24 = 2400 bps, and 12 = 1200 bps; omitted for 300 bps). The 1984 CCITT Red Book does not include these connect messages. Default is 0 (connect message disabled).

To disable the CNX yy connect message responses, type: **PRS CM ; 0 <LF>**

To enable responses, type: **PRS CM ; 1 <LF>**

---

*Note*    After modifying this option you should save the setting by using the **NVW** command

---

**PRS DR    DTE Data Rate**

PRS DR, in conjunction with the hand-shake mode command (PRS HM), controls the DTE speed. There are several configurations to consider:

- An automatic handshake mode, e.g., V.32 *bis* auto [PRS HM ; 2], V.32 auto [PRS HM ; 4], V.22 *bis* only [PRS HM ; 6], takes precedence over the PRS DR selection, and the modem tries for the highest VF speed common to the two commands.
- For 1200 bps V.22 operation, select **PRS HM ; 7**. **PRS HM** . Since **6** is an auto mode, setting the DTE to 1200 bps (**PRS DR ; 3**) will not force the connection to 1200 bps.
- When the modem is optioned for an automatic hand-shake mode and direct V.14 asynchronous mode (AT command **\N1**), it sends a connect message to the DTE at the selected PRS DR speed. In order to pass data, the user must change the DTE's speed to match the displayed connect speed.
- When the modem is optioned for speed buffering (AT command **\N0**) or an error correcting protocol (AT commands **\N2** through **\N5**), the PRS DR command alone selects the DTE speed, and the PRS HM command selects the hand-shake mode.
- When the modem is optioned for a fixed handshake mode and direct mode (AT command **\N1**), the PRS DR command not only selects the DTE speed, but also forces the VF speed to match it. If the required VF speed is not available the modem drops the call. (This does not apply to V.22 *bis* only, which handshakes at the highest VF speed.)
- When using the modem in direct mode (AT command **\N1**), if the desired connect speed is known, set the speed to match using the PRS DR command. Set the DTE to the same speed and **"AT"** the modem so that it will know at what speed to send messages.
- The modem must be in the AT command set mode in order to configure the **\Nn** AT command.

To invoke this command, type **PRS DR ; n <LF>** where *n* is the DTE rate, as follows:

<i>n</i>	rate
0	Autobaud
1	Last connect speed
2	300 bps
3	1200 bps
4	2400 bps
5	4800 bps
6	7200 bps

<i>n</i>	rate
7	9600 bps
8	12,000 bps
9	14,400 bps
10	16,800 bps
11	19,200 bps
12	21,600 bps
13	24,000 bps

<i>n</i>	rate
14	26,400 bps
15	28,800 bps
16	38,400 bps
17	57,600 bps
18	76,800 bps
19	115,200 bps
20	128,000 bps

### PRS HM Handshake Mode

PRS HM selects the handshake mode. Consider the following:

- When the modem is optioned for an external transmit clock source (PTM ; 1), the modem should be optioned for a fixed - not an automatic - hand-shake mode (e.g., select V.32 bis only [PRS HM ; 3] instead of V.32 bis automatic [PRS HM ; 2]). The modem will then handshake only at the speed given to it by the DTE.
- For 1200 bps V.22 operation, select PRS HM ; 7. PRS HM ; 6 is an auto mode, so setting the DTE to 1200 bps (PRS DR ; 3) will not force the connection to 1200 bps.

To invoke this command, type: **PRS HM ; n <LF>** where *n* is the handshake mode, as follows:

<i>n</i>	mode
0	V.34 auto (28.8 kbps to 300 bps)
1	V.34 only (28.8 kbps to 2400 bps)
2	V.32 <i>bis</i> automatic (14.4 kbps to 300 bps)
3	V.32 <i>bis</i> only (14.4 kbps to 4800 bps)
4	V.32 automatic (9600 bps to 300 bps)
5	V.32 only (9600 bps to 4800 bps)
6	V.22 <i>bis</i> only (2400 bps to 1200 bps)
7	V.22 only (1200 bps)
8	Bell 212 only (1200 bps)
9	Bell 103 only (300 bps)
10	V.21 only (300 bps)

### PRS TR Termination Character

PRS TR selects the ASCII character that represents the command termination character in the asynchronous mode. The command termination character is the character used to enter a command for interpretation by the modem. Select the command termination character that is compatible with your preference and your terminal. Default is 10 or <LF> (line feed).

To select the line feed control-character as the command terminator, type: **PRS TR ; 10 <LF>**

To select the vertical tabulation control-character, type: **PRS TR ; 11 <LF>**

To select the form feed control-character, type: **PRS TR ; 12 <LF>**

### PTM Synchronous Timing

PTM selects the clock source when operating in a synchronous data mode.

To select internal clock (supplied by the modem), type: **PTM ; 0 <LF>**

To select external clock (supplied by the DTE), type: **PTM ; 1 <LF>**

To select receiver wrap clock (derived from received data), type: **PTM ; 2 <LF>**

## V.25 bis Communication Commands

### CIC Connect Incoming Call

CIC causes the modem to automatically answer the current incoming call. It temporarily modifies the automatic answering function so that the modem immediately answers the call, ignoring the number of automatic answering rings selected with the PRS AA command. Ten seconds after one incoming call is completed, normal automatic answering is restored.

To invoke this command, type: **CIC <LF>**

### CRN Call Requested Number

CRN causes the modem to dial a telephone number, supplied with the command, to initiate data communication with another modem. If the handshake abort timer (AT command S7=x) times out before the modem detects answer tone, the modem will return on-hook.

To invoke this command, type: **CRN n <LF>** where *n* is the telephone number to be dialed. The modem recognizes only the characters contained in *n* that are listed in [Table 5-1](#).

*Example: To dial 555-1234, type: CRN 5551234 <LF>*

### CRS Call Re-quested Stored Telephone Number

CRS causes the modem to dial the telephone number stored in a specified modem memory cell. The number to be dialed must have been stored in a memory cell previously by means of the PRN command.

To invoke this command, type: **CRS n <LF>** where *n* is the number (from 0 to 9) of the memory cell that contains the telephone number to be dialed.

*Example: To dial the number stored in memory cell 5, type: CRS 5 <LF>*

### DIC Disconnect Incoming Call

DIC causes the modem to temporarily disable the automatic answering function and ignore an incoming call. Ten seconds after one incoming call is completed, normal automatic answering is restored.

To invoke this command, type: **DIC <LF>**

## V.25 bis Command Operating Procedures

The following paragraphs describe communication operating procedures for the V.F 28.8 using the ITU-T V.25 bis command set. The descriptions include procedures for originating, answering, and terminating a call in the 108.2 and 108.1 modes.

### 108.2 Mode Operating Procedures

#### Originating a Call in 108.2 Mode

1. From the DTE, use the CRN or CRS command to dial the desired telephone number.
2. When communication is established, your terminal displays the CNX response (if enabled with the **PRS CM ; 1** command) and you may transfer data.

#### Automatic Call Answering

1. Enable automatic answering by typing: **PRS AA ; n <LF>** where *n* is the number of rings (from 1 to 255) that the modem will wait before it performs automatic answering. The default is 4.
2. The modem will answer any incoming call automatically after the specified number of rings.
3. When communication is established, your terminal will display the CNX response and data transfer can take place. If communication is not established, your terminal will display the appropriate response and the modem will return to the command mode.

#### Manual Call Answering

The command **PRS AA ; 0 <LF>** disables automatic call answering. When automatic answering is disabled, use the following procedure to establish communication by manually answering calls:

1. When your terminal displays the INC result code to indicate an incoming call, type: **CIC <LF>**
2. When communication is established, your terminal will display the CNX response and data transfer can take place. If communication is not established, your terminal will display the appropriate response and the modem will return to the command mode.

#### Automatic Call Termination

The modem will automatically terminate a call if:

- Terminal interface signal 108.2 (DTR) is turned Off while the modem is in data mode. This mode of automatic termination functions only when DTR is optioned for normal operation; it is disabled if 108.2 is optioned for forced On operation.
- The handshaking sequence is not completed within the abort time period (selected by the S7=*x* AT command; default is 30 seconds) after originating or answering a call.
- A long space is received and long space disconnect has been enabled by the **Yn** AT command. This mode of automatic termination functions only when the modem is operating at 300, 1200, or 2400 bps.

### Originating a Call

The general principle for establishing a call between the DTE and DCE complies with the V.25 *bis* 108.2 mode of operation.

#### DTE

1. Turn On DTR.
2. Send Command: CRN or CRS.
3. Wait for the connection (or abort the call by turning Off DTR).
4. Recognize successful connection when DSR comes On.
5. Recognize connected data rate from the CNX message.
6. Turn On RTS to send data.
7. Turn Off DTR to terminate call.

#### DCE

1. Turn On CTS.
2. Send VAL response.
3. Dial phone number.
4. Turn Off CTS when answer tone is detected or send CFI response in cases where the call has failed.
5. Turn On DSR and DCD when hand-shake is successful.
6. Send connect CNX message.
7. Enter data transfer mode.
8. Turn On CTS in response to RTS.
9. Disconnect from line.
10. Turn Off CTS, DSR, and DCD.
11. Send CFI call abort message.

### Answering a Call

#### DTE

1. Turn On DTR.
2. Send CIC command to permit answering, or send DIC command to disregard the incoming ring.
3. Recognize successful connection when DSR comes On.
4. Recognize connected data rate from the CNX message.
5. Turn On RTS to send data.
6. Turn Off DTR to terminate call.

#### DCE

1. After detection of an incoming ring, send INC message. When Auto Answer is enabled, modem will answer call after preset number of rings if DTR is On.
2. The CIC command is not required.
3. Disregard incoming ring if DIC is received.
4. Answer call after the next ring if CIC is received.
5. At next ring, go off-hook.
6. Turn Off CTS.
7. Turn On DSR and DCD when going through handshake successfully.
8. Send connect CNX message. Go into data transfer mode.
9. Turn On CTS in response to RTS.
10. Disconnect from line.
11. Turn Off CTS, DSR, and DCD.
12. Send CFI call abort message



## 108.1 Mode Operating Procedures

### Originating a Call Automatically

1. Prior to the time of calling a telephone number must be stored in the modem's memory cell 0. That can be done with either the 108.2 mode PRN command or the AT command `&Zn=nnn`.
2. To initiate an automatically dialed call in 108.1 mode, turn On terminal interface circuit 108.1.
3. When communication is established with the remote modem, you may transfer data.

### Originating a Call Manually

1. Lift the telephone handset, listen for a dial tone, and call the remote site.
2. When calling an automatically answered site, turn On terminal interface circuit 108.1 or press the talk/data switch (D/TK key) on the front panel when you hear answer tone from the remote modem.
3. When calling a manually answered site, ask the attendant answering the call to transfer the remote modem to data mode. When you hear answer tone, turn On terminal interface circuit 108.1 - or press the talk/data switch (D/TK key) on the front panel.
4. When communication is established, you may transfer data.

### Automatic Call Answering

The modem can answer calls automatically in 108.1 mode if the function has not been disabled. (Refer to [PRS AA Automatic Answering](#).) The following occurs when the modem detects an incoming call:

1. After the specified number of rings, the modem turns On circuit 125 (Call Indicator) to alert the DTE that an incoming call is trying to make a connection.
2. If the DTE is prepared to accept the connection it responds by turning On circuit 108.1. While Call Indicator is On, circuit 108.1 acts as the command to perform automatic answering.
3. The modem then goes off-hook, performs handshaking, and when successfully completed, begins data transfer with the remote modem.

### Manual Call Answering

When automatic answering is disabled, establish communication as follows:

1. When the telephone rings, lift the handset.
2. When the remote site attendant asks you to place the modem in data mode, turn On terminal interface 108.1, or press the talk/data switch (D/TK key) on the front panel.
3. Hang up the handset. You may now commence data communications.

### Terminating a Call

To terminate communication, turn Off terminal interface circuit 108.1 or press the talk/data switch.



# Chapter 6: Tests

## Overview

This chapter describes tests that can be invoked to isolate a trouble condition. The tests can isolate a problem to the data connection, data set operation, or the DTE interface level.

[Figure 6-1](#) defines the fault isolation sequence.

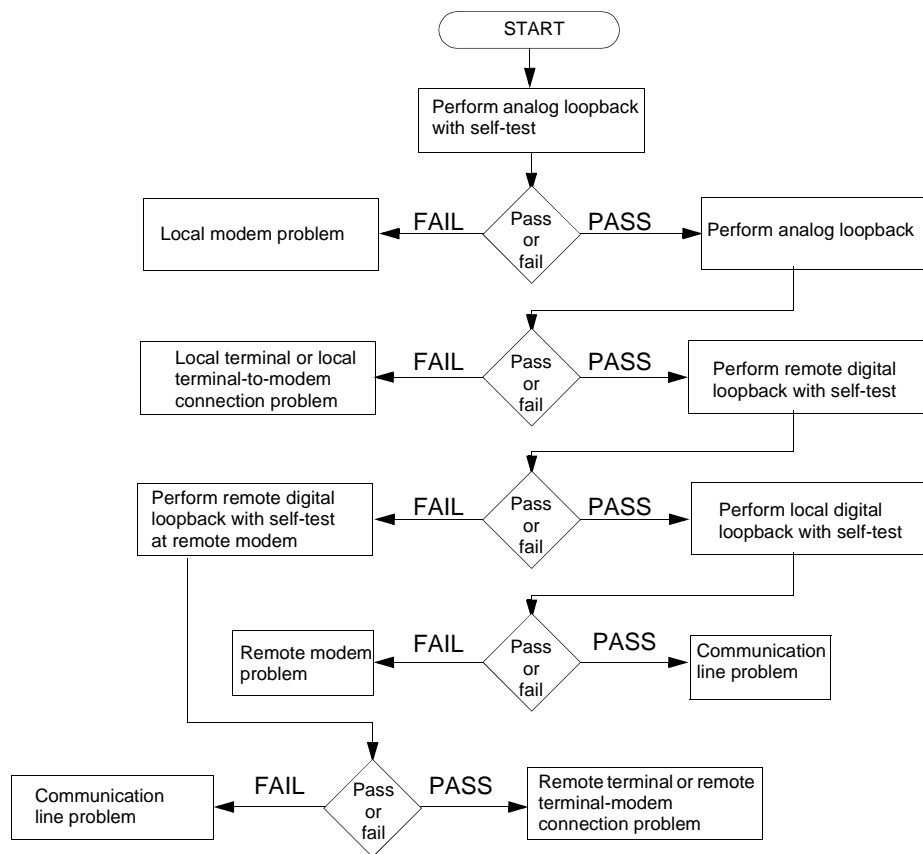

**Figure 6-1** Fault Isolation Sequence

- Once a modem is in **Slave RDL**, it will ignore all requests other than **LL**.
- If an **RDL** request does not get a response from the Slave modem at 2400 bps, the Master will drop the line.

## Analog Loopback

The ANALOOP test can be controlled from the front panel or by AT commands. The analog loopback (ANALOOP) test mode is used to isolate problems in the data set operation and the DTE interface, such as modem modulator/demodulator operation, DTE receive/transmit operation, and DTE interface operation.

This test is illustrated in [Figure 6-2](#), followed by the test procedures.

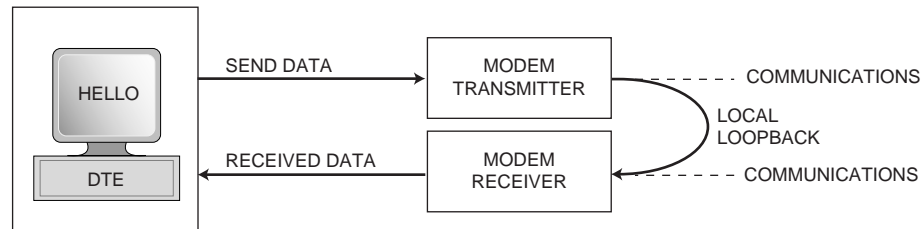

**Figure 6-2** Analog Loopback Test

### Special Considerations

- If the modem is used in `\N0`, `\N2`, `\N3`, `\N4` or `\N5` modes with a fixed DTE speed, it will not issue a **CONNECT** message.
- If the modem is used in `\N1` mode, the modem will issue a **CONNECT** \_ \_ \_ \_ message at the last known DTE rate, since the ANALOOP handshake speed may not match the DTE speed selected.
- When the DTE rate and hand-shake rate differ, change the DTE speed to match the rate reported by the **CONNECT** message.

## Analog Loopback Test Procedures

### Front Panel Procedure

1. Start the test by pressing the front panel **LL** button.
2. The modem displays the test name (**LL**) and flashes the **TM** LED while it is setting up the test.
3. The modem then illuminates the **TM** LED and displays **.3** while the test is running.
4. Enter test data at the remote DTE, then compare it with the data that is looped back and displayed by the DTE.
5. If errors occur frequently, a problem may exist in one of the following areas:
  - modem failure
  - DTE failure
  - DTE-to-modem connection failure
6. Refer to the Fault Isolation Sequence ([Figure 6-1](#)) to identify the problem.
7. To end the test, press the front panel **LL** button .

### AT Command Procedure

1. Start the test by typing **AT&T1** and then press **Enter**.  
If the modem responds with an error message, reset the test mode (**AT%0** and press **Enter**), then re-enter the command.
2. The modem flashes the **TM** LED while it is setting up the test, then illuminates the **TM** LED and displays **.3** while the test is running.
3. To end the test, type the escape sequence (**+++**).
4. Once the modem is in command mode, type **AT&A0** and then press **Enter** to go back on-line.

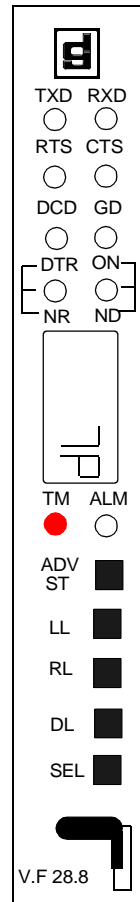

### Analog Loopback with Self-Test

ANALLOOP may be combined with Self-Test, as illustrated in [Figure 6-3](#). This test provides a means for the customer to determine whether the problem is in the local data set.

In Analog Loopback with Self-test, a pattern is generated by the transmitter and sent to the receiver for analysis. The pattern is made up of alternate ones and zeros for speeds of 1200 and 2400 bps. For all other speeds the modem generates a 511 test pattern. The number of errors is displayed on the screen.

---

**Note** *Analog Loopback with Self-Test is not operational when the modems are passing data at 300 bps.*

---

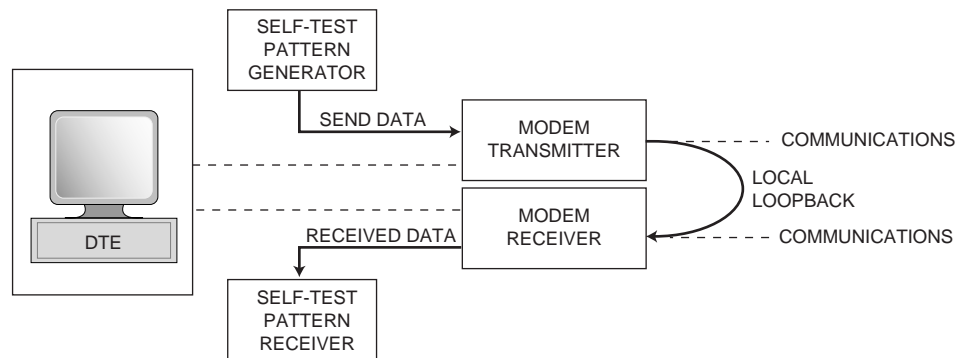

**Figure 6-3** Analog Loopback with Self-Test

---

## Analog Loopback Self-Test Procedures

### Front Panel Procedure

1. Start the test by pressing the front panel **LL** button, then press the **ADV ST** button.
2. The modem displays the test names (**LL** and **ADV ST**) and flashes the **TM** LED while it is setting up the test.
3. The modem then illuminates the **TM** LED and displays four digits of the error count (**0000 - 9999**) while the test is running.

---

**Note** Any number greater than 0 indicates the modem has failed the test.

---

4. The test terminates when the **S-Register 18** timer expires.
5. To end the test, press the front panel **LL** button .

### AT Command Procedure

1. Start the test by typing **AT&T8** and then press **Enter**.  
If the modem responds with an error message, reset the test mode (**AT%0** and press **Enter**), then re-enter the command.
2. The modem flashes the **TM** LED while it is setting up the test, then illuminates the **TM** LED while the test is running.
3. When the test is terminated, the screen displays a four-digit number corresponding to the number of errors detected during the test.

---

**Note** Any number greater than 0 indicates the modem has failed the test.

---

4. To end the test, type the escape sequence (**+++**).
5. Once the modem is in command mode, type **AT&AT0** and then press **Enter** to go back on-line.

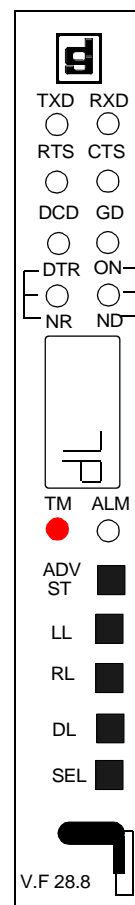

## Digital Loopback

The modem can be commanded to enter digital loopback via the front panel or AT commands. This loopback is used while a call to the distant modem is established.

In digital loopback, the local received data is coupled to the transmitter input, so that the remote unit can perform a loopback test without commanding remote loopback. This test path is illustrated in [Figure 6-4](#), followed by the test procedure.

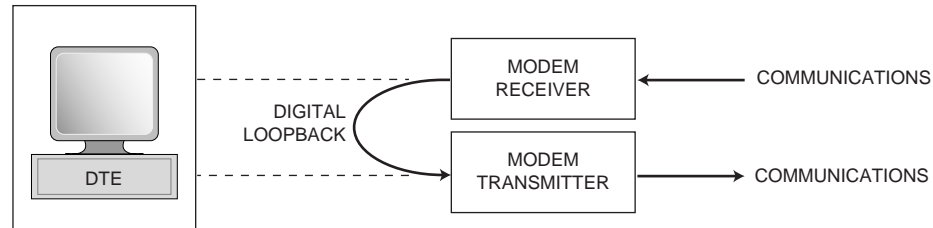

**Figure 6-4** Digital Loopback Test

### Special Considerations

- This test must be performed with the modems in synchronous mode, asynchronous wire mode (`\N0`), or asynchronous direct mode (`\N1`). The modem must be in data mode for at least 30 seconds before the test can be initiated.
- In asynchronous mode the clocks will be clamped at the EIA interface.



## Digital Loopback Test Procedures

### Front Panel Procedure

1. Establish data communications with a remote modem.
2. Start the test by pressing the front panel **DL** button.
3. The modem displays the test name (**DL**) and flashes the **TM** LED while it is setting up the test.
4. The modem then illuminates the **TM** LED and displays **.1** while the test is running.
5. Direct the remote attendant to enter test data at the remote DTE, then compare it with the data that is looped back and displayed by the DTE.
6. If errors occur frequently, a problem may exist in one of the following areas:
  - local or remote modem failure
  - remote DTE failure
  - remote DTE-to-modem connection failure
  - communication line failure
7. Refer to the Fault Isolation Sequence ([Figure 6-1](#)) to identify the problem.
8. To end the test, press the front panel **DL** button .

### AT Command Procedure

1. Start the test by typing the escape sequence (**+++**). The modem will switch from data mode to command mode.
2. Once in command mode, type **AT&T3** and then press **Enter**.  
If the modem responds with an error message, reset the test mode (**AT%0** and press **Enter**), then re-enter the command.
3. The modem flashes the **TM** LED while it is setting up the test, then illuminates the **TM** LED and displays **.1** while the test is running.
4. Direct the remote attendant to enter test data at the remote DTE, then compare it with the data that is looped back and displayed by the DTE.
5. If errors occur frequently, a problem may exist in one of the following areas:
  - local or remote modem failure
  - remote DTE failure
  - remote DTE-to-modem connection failure
  - communication line failure
6. Refer to the Fault Isolation Sequence ([Figure 6-1](#)) to identify the problem.
7. To end the test, type **AT&T0** and then press **Enter**.
8. To go back on-line, type **ATO** and then press **Enter**.

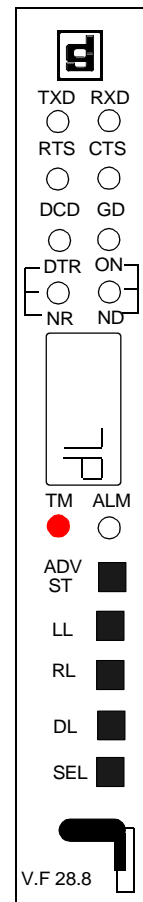

## Remote Digital Loopback

Remote Digital Loopback ([Figure 6-5](#)) is controlled at the local end and can be commanded from the front panel, or with AT commands, or by the DTE's EIA pin 21.

The loopback can be commanded only after a call is established and both ends are in data mode. In this loop, the demodulator's descrambled received data at the remote end is coupled to the remote transmitter input for transmission back to the local end.

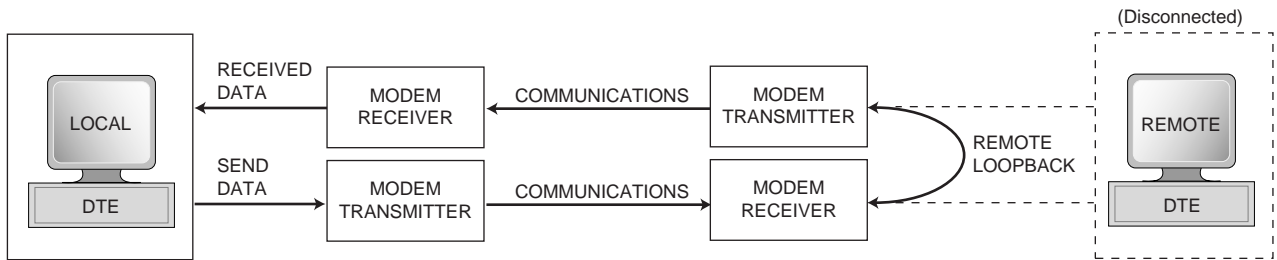

**Figure 6-5** Remote Digital Loopback

### Special Considerations

- For remote digital loopback test, the remote DTE or terminal is disconnected from its modem.
- This test is not operational when the modems are passing data at 300 bps.
- Your modem is factory set to acknowledge a remote modem's request to participate in a remote digital loopback test initiated from the remote location. If you do not want to acknowledge such requests, enter **AT&T5&W**. If you later decide to acknowledge such requests, enter **AT&T4&W**.
- This test cannot be performed if the remote modem is optioned to ignore a remote digital loopback command. If the modems are operating at V.22 *bis* speeds and the local modem issues the **RDL** command to a remote unit so optioned, the local modem will drop the connection.
- This test must be performed with the modems in synchronous mode, asynchronous wire mode (**\N0**), or asynchronous direct mode (**\N1**). The modem must be in data mode for at least 30 seconds before the test can be initiated.

## Remote Digital Loopback Procedures

### Front Panel Procedure

1. Establish data communications with a remote modem.
2. Confirm with the remote modem attendant that the remote is optioned to accept Remote Digital Loopback commands.
3. Start the test by pressing the front panel **RL** button.
4. The modem displays the test name (**RL**) and flashes the **TM** LED while it is setting up the test.
5. If the local modem initiated the test, the modem then illuminates the **TM** LED and displays **.2** while the test is running. If the remote modem initiated the test, the local modem displays **.3** and **.4** while the test is running.
6. Enter test data at the local DTE, then compare it with the data that is looped back and displayed by the DTE.
7. Once the test is running
8. If errors occur frequently, a problem may exist in at the local or remote modem, the local DTE, the local DTE-to-modem connection, or the communication line. Refer to the Fault Isolation Sequence ([Figure 6-1](#)) to identify the problem.
9. To end the test, press the front panel **RL** button .

### AT Command Procedure

1. Start the test by typing the escape sequence (**+++**). The modem will switch from data mode to command mode.
2. Once in command mode, type **AT&T6** and then press **Enter**.  
If the modem responds with an error message, reset the test mode (**AT%0** and press **Enter**), then re-enter the command.
3. If the local modem initiated the test, the modem flashes the **TM** LED while it is setting up the test, then illuminates the **TM** LED and displays **.2** while the test is running.  
If the remote modem initiated the test, the local modem displays **.3** and **.4** while the test is running.
4. Enter test data at the remote DTE, then compare it with the data that is looped back and displayed by the DTE.
5. If errors occur frequently, a problem may exist in at the local or remote modem, the local DTE, the local DTE-to-modem connection, or the communication line. Refer to the Fault Isolation Sequence ([Figure 6-1](#)) to identify the problem.
6. To end the test, type **AT&T0** and then press **Enter**.
7. To go back on-line, type **ATO** and then press **Enter**.

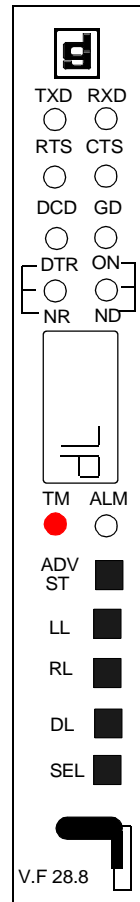

## Remote Digital Loopback with Self-Test

Remote Digital Loopback with Self-Test, illustrated in [Figure 6-6](#), is controlled at the local end. It can be commanded from the front panel or with AT commands. This command can only be entered after the call is established and both ends are in the data mode.

The test causes the local modem to generate a pattern that is transmitted across the telephone line to the remote modem's receiver, looped through to the remote modem's transmitter, and sent back across the telephone line to the local modem's receiver for analysis. The pattern is made up of alternate ones and zeros for speeds of 1200 and 2400 bps. For all other speeds the modem generates a 511 test pattern. The number of errors is displayed on the screen. This test checks both modems and the telephone line.

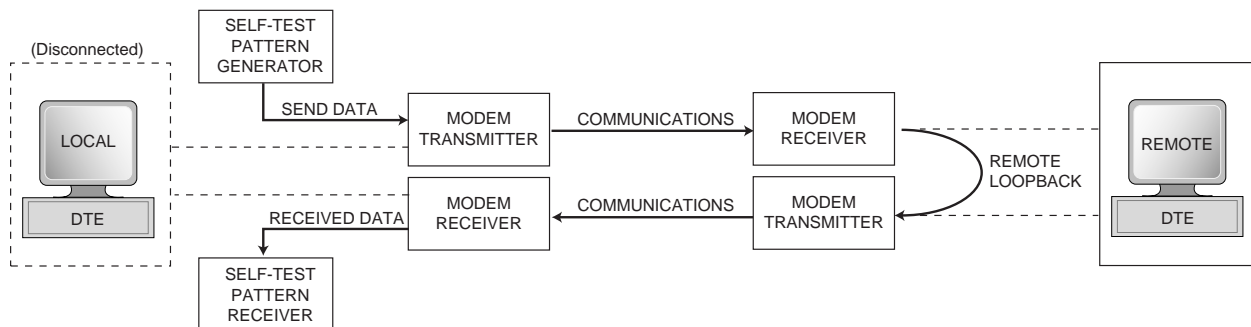

**Figure 6-6** Remote Digital Loopback with Self-Test

### Special Considerations

- For remote digital loopback with self-test, the local DTE or terminal is disconnected from its modem.
- This test is not operational when the modems are passing data at 300 bps.
- This test cannot be performed if the remote modem is configured to ignore a remote digital loopback command.
- This test must be performed with the modems in synchronous mode, asynchronous wire mode (`\N0`), or asynchronous direct mode (`\N1`). The modem must be in data mode for at least 30 seconds before the test can be initiated.

## Remote Digital Loopback with Self-Test Procedures

### Front Panel Procedure

1. Establish data communications with a remote modem.
2. Confirm with the remote modem attendant that the remote is optioned to accept Remote Digital Loopback commands.
3. Start the test by pressing the front panel **RL** button and the **ADV ST** button.
4. The modem displays the test names (**RL** and **ADV ST**) and flashes the **TM** LED while it is setting up the test.
5. The modem then illuminates the **TM** LED and displays four digits of the error count (**0000 - 9999**) while the test is running.

---

**Note** *Error counts greater than 9999 are indicated by illuminating **.1** and displaying the four least significant digits.*

---

6. The test terminates when the **S-Register 18** timer expires if a value has been entered by the user (1 - 60 seconds). Otherwise, the factory default (**000**) will cause the test to run until ended by the user.
7. To end the test, press the front panel **RL** button .

### AT Command Procedure

1. Establish data communications with a remote modem.
2. Confirm with the remote modem attendant that the remote is optioned to accept Remote Digital Loopback commands.
3. Start the test by typing the escape sequence (**+++**).
4. Once the modem is in command mode type **AT&T7** and then press **Enter**. If the modem responds with an error message, reset the test mode (**AT%0** and press **Enter**), then re-enter the command.
5. The modem flashes the **TM** LED while it is setting up the test, then illuminates the **TM** LED while the test is running.
6. When the test is terminated, the screen displays a four-digit number corresponding to the number of errors detected during the test.

---

**Note** *Any number greater than 0 indicates the modem has failed the test.*

---

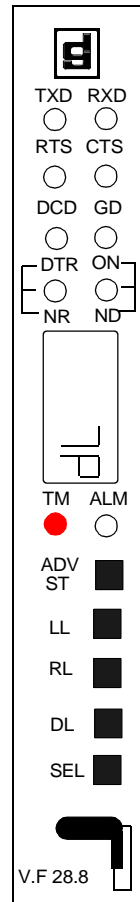

## End-to-End Self-Test

End-to-End Self Test, illustrated in [Figure 6-7](#), requires operators at both the local and remote modem. It can be commanded from the front panels or with AT commands. The commands can only be entered after the call is established and both ends are in the data mode. The test causes each modem to generate a pattern and to transmit it to the other modem. The modem receiving the pattern checks it for errors.

The patterns are made up of alternate ones and zeros for speeds of 1200 and 2400 bps. For all other speeds the modems generate a 511 test pattern. The number of errors received is displayed on the screen. This test checks the operation of both modems and the communications line.

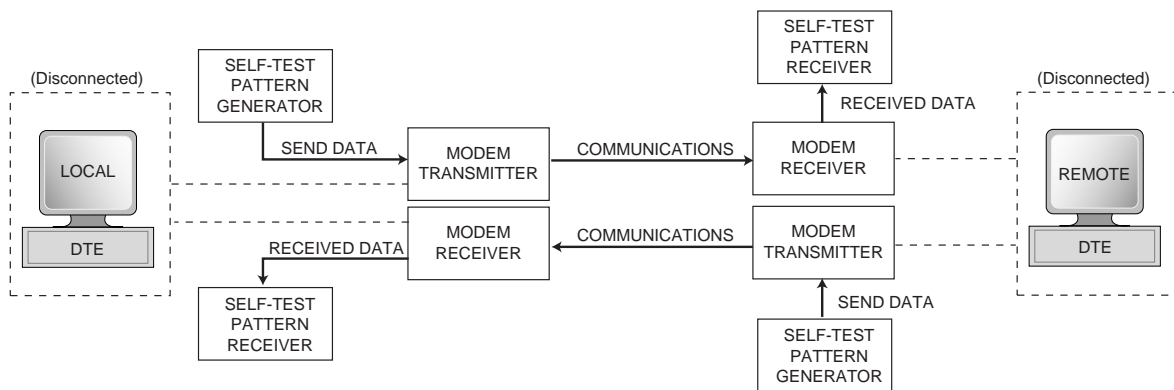

**Figure 6-7** End-to-End Self-Test

### Special Considerations

- For the End-to-End self-test, both the local and remote DTEs or terminals are disconnected from their modems.
- This test is not operational when the modems are passing data at 300 bps.
- This test must be performed with the modems in synchronous mode, asynchronous wire mode (`\NO`), or asynchronous direct mode (`\N1`). The modem must be in data mode for at least 30 seconds before the test can be initiated.

## End-to-end Self-Test Procedures

### Front Panel Procedure

1. Start the test by pressing the front panel **ADV ST** button.
2. The modem displays the test name (**ADV ST**) and flashes the **TM** LED while it is setting up the test.
3. The modem then illuminates the **TM** LED and displays four digits of the error count (**0000 - 9999**) while the test is running.

---

**Note** *Error counts greater than 9999 are indicated by illuminating **.1** and displaying the four least significant digits.*

---

4. The test terminates when the **S-Register 18** timer expires if a value has been entered by the user (1 - 60 seconds). Otherwise, the factory default (**000**) will cause the test to run until ended by the user.
5. To end the test, press the front panel **LL** button .

### AT Command Procedure

1. Start the test by typing at each modem **AT&T9** and then press **Enter**. If the modem responds with an error message, reset the test mode (**AT%0** and press **Enter**), then re-enter the command.
2. The modem flashes the **TM** LED while it is setting up the test, then illuminates the **TM** LED while the test is running.
3. When the test is terminated, the screen displays a four-digit number corresponding to the number of errors detected during the test.

---

**Note** *Any number greater than 0 indicates the modem has failed the test.*

---

4. The test terminates when the **S-Register 18** timer expires if a value has been entered by the user (1 - 60 seconds). Otherwise, the factory default (**000**) will cause the test to run until ended by the user.
5. To end the test, type the escape sequence at each modem (**+++**).
6. Once the modems are in command mode, type **AT&T0** and then press **Enter**.

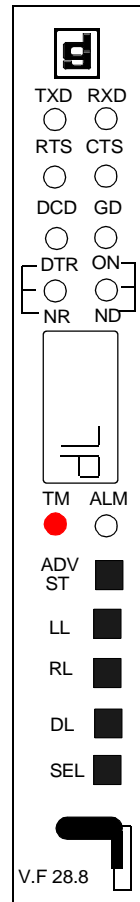





# Appendix A: ASCII Character Set

**Table A-1** ASCII Character Set Reference

Character	Decimal	Hexa-decimal	Binary
NUL	0	00	00000000
CTRL A (SOH)	1	01	00000001
CTRL B (STX)	2	02	00000010
CTRL C (ETX)	3	03	00000011
CTRL D (EOT)	4	04	00000100
CTRL E (ENQ)	5	05	00000101
CTRL F (ACK)	6	06	00000110
CTRL G (BEL)	7	07	00000111
CTRL H (BS)	8	08	00001000
CTRL I (HT)	9	09	00001001
CTRL J (LF)	10	0A	00001010
CTRL K (VT)	11	0B	00001011
CTRL L (FF)	12	0C	00001100
CTRL M (CR)	13	0D	00001101
CTRL N (SO)	14	0E	00001110
CTRL O (SI)	15	0F	00001111
CTRL P (DLE)	16	10	00010000
CTRL Q (XON)	17	11	00010001
CTRL R (DC2)	18	12	00010010
CTRL S (XOFF)	19	13	00010011
CTRL T (DC4)	20	14	00010100
CTRL U (NAK)	21	15	00010101
CTRL V (SYN)	22	16	00010110
CTRL W (ETB)	23	17	00010111
CTRL X (CAN)	24	18	00011000
CTRL Y (EM)	25	19	00011001
CTRL Z (SUB)	26	1A	00011010
ESC	27	1B	00011011
FS	28	1C	00011100
GS	29	1D	00011101
RS	30	1E	00011110
US	31	1F	00011111
@	64	40	01000000

Character	Decimal	Hexa-decimal	Binary
SP	32	20	00100000
!	33	21	00100001
"	34	22	00100010
#	35	23	00100011
\$	36	24	00100100
%	37	25	00100101
&	38	26	00100110
'	39	27	00100111
(	40	28	00101000
)	41	29	00101001
*	42	2A	00101010
+	43	2B	00101011
,	44	2C	00101100
-	45	2D	00101101
.	46	2E	00101110
/	47	2F	00101111
0	48	30	00110000
1	49	31	00110001
2	50	32	00110010
3	51	33	00110011
4	52	34	00110100
5	53	35	00110101
6	54	36	00110110
7	55	37	00110111
8	56	38	00111000
9	57	39	00111001
:	58	3A	00111010
;	59	3B	00111011
<	60	3C	00111100
=	61	3D	00111101
>	62	3E	00111110
?	63	3F	00111111
	`96	60	01100000

**Table A-1** ASCII Character Set Reference

Character	Decimal	Hexa-decimal	Binary
A	65	41	01000001
B	66	42	01000010
C	67	43	01000011
D	68	44	01000100
E	69	45	01000101
F	70	46	01000110
G	71	47	01000111
H	72	48	01001000
I	73	49	01001001
J	74	4A	01001010
K	75	4B	01001011
L	76	4C	01001100
M	77	4D	01001101
N	78	4E	01001110
O	79	4F	01001111
P	80	50	01010000
Q	81	51	01010001
R	82	52	01010010
S	83	53	01010011
T	84	54	01010100
U	85	55	01010101
V	86	56	01010110
W	87	57	01010111
X	88	58	01011000
Y	89	59	01011001
Z	90	5A	01011010
[	91	5B	01011011
/	92	5C	01011100
]	93	5D	01011101
^	94	5E	01011110
-	95	5F	01011111

Character	Decimal	Hexa-decimal	Binary
a	97	61	01100001
b	98	62	01100010
c	99	63	01100011
d	100	64	01100100
e	101	65	01100101
f	102	66	01100110
g	103	67	01100111
h	104	68	01101000
i	105	69	01101001
j	106	6A	01101010
k	107	6B	01101011
l	108	6C	01101100
m	109	6D	01101101
n	110	6E	01101110
o	111	6F	01101111
p	112	70	01110000
q	113	71	01110001
r	114	72	01110010
s	115	73	01110011
t	116	74	01110100
u	117	75	01110101
v	118	76	01110110
w	119	77	01110111
x	120	78	01111000
y	121	79	01111001
z	122	7A	01111010
{	123	7B	01111011
	124	7C	01111100
}	125	7D	01111101
~	126	7E	01111110
DEL	127	7F	01111111





---

WORLD HEADQUARTERS: General DatComm • 6 Rubber Avenue • Naugatuck, Connecticut • USA 06770