

Lesson 4

Saving Your Quilts

You will find that you can achieve great success and avoid frustration when using Quilt Design Wizard™ if you have a thorough understanding of how the program saves your quilt files. In this lesson we'll review the important steps of saving quilts.

- 1 Double-click the **Quilt Wizard** icon on your desktop to start the program.

You'll see a message that says, **A backup of your last Wizard session exists. Would you like to open it?** This message appears because we exited at the end of Lesson 3 without saving. The main purpose for this message is to help auto-recover if your computer has a power surge or some other problem that abruptly closes your project without giving you time to save it.

- 2 Click **No**.
- 3 Click the **Layout** tab.

Remember to always click on the down pointing arrows to open controls.

- 4 Click **Style**. Click **Horizontal**.
- 5 Click **Mattress Size**. Click **Wall**.
- 6 Click **Sashing**. Click **No**.
- 7 Click **Block Size**. Click **6**.
- 8 Click the **Borders** tab.
- 9 Click the **Add** button.
- 10 Position the mouse cursor over the images at the top to display the style names.
- 11 Click the fourth image, **Corner Blocks**.
- 12 Under **Adjust size**, click to place a check in **All** if it is not checked already.
- 13 Drag any one of the sliders so that the border is **4** inches wide.
- 14 Click the **Blocks** tab.
- 15 Click **Blocks in the Library**.

Once you've opened the library control, keep in mind that here you position the mouse directly over the name of the category and click to display the blocks in that category.

- 16 Scroll up or down until you see **Square in a Square** and click on it to display the blocks.
- 17 Click on the second block – *Economy II*.
- 18 Click the **Set** tool.
- 19 **Ctrl** + click on any block in the layout.
- 20 Click on the third block – *Economy Variation*.



Step 1

Quilt Wizard



Step 2

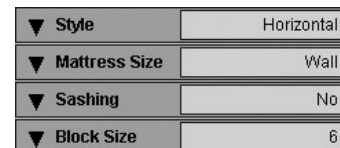

Steps 4-7

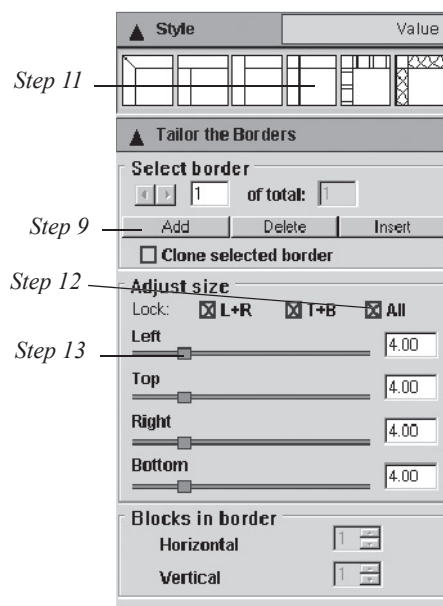

Step 11

Step 9

Step 12

Step 13

Step 15

Step 16

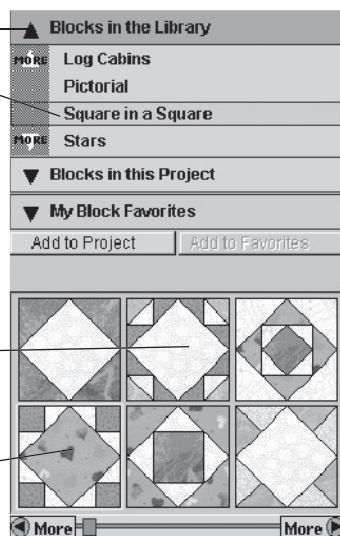

Step 18

Step 20
*Economy
Variation*Step 17
Economy II

- 21 **Alt** + click on any block to set this block in alternating locations.
- 22 Let's get a block from a different category to set in the border. Scroll up until you see **Simple Blocks** and click to display the blocks.
- 23 Click on the fourth block – *Uneven Bars*.
- 24 **Ctrl** + click on any border. This will set the block in all four borders at once. It looks odd because the left and right borders need rotating.
- 25 Click the **Rotate** tool.
- 26 Click on the **left** border. This will rotate the block to match the top and bottom borders.
- 27 Click the **right** border to rotate the block. Our quilt is complete. Let's save it.
- 28 Click the **Save** tool. The *Save As* dialog box displays.
- 29 The **Save in:** box displays the folder name where your quilt projects will be saved. Make sure you remember where you are saving your files. In Lesson 1 we saved the project **My First Quilt** in *My Documents*. If you need to, use the down arrow to navigate to the *My Documents* folder and double click on it so that the **Save in:** box displays *My Documents*.
- 30 In the **File name:** typing box, type **Lesson 4a**.
- 31 Click the **Save** button. You'll see the name of the file on the title bar at the top of the screen.

**Tip**

All Quilt Design Wizard™ files automatically get saved with the 3-letter extension QDW. You may or may not see these letters on your title bar depending on your computer's Windows settings.

In the other lessons, once we had completed a quilt we exited the program. This time we won't exit. We'll just start a new quilt.

- 32 Click the **New** tool.
- 33 If you see a message asking if you want to save changes to Lesson 4a, click **Yes**.

You'll see a new empty quilt layout. The name of the file on the title bar now says *Untitled*. Let's make a quick quilt. We'll use this layout without visiting the **Layout** or **Borders** tab. We'll use the **Simple Blocks**.

- 34 Click the **Set** tool
- 35 Click the third block – *Rail Fence III*.

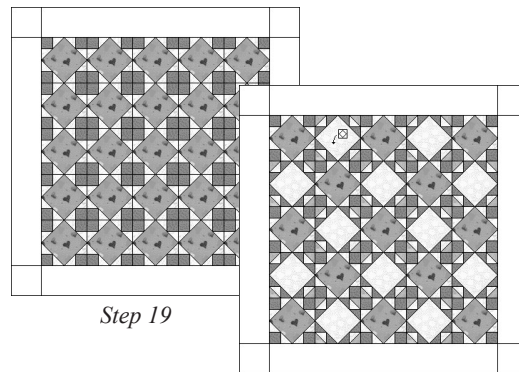

Step 19

Step 21

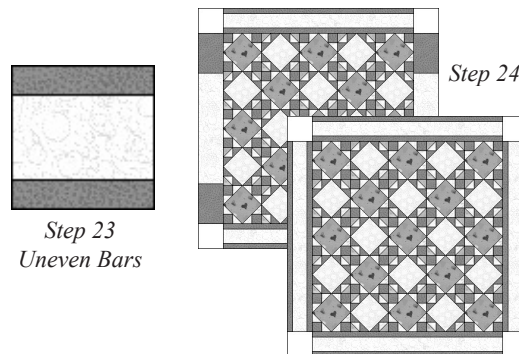
Step 23
Uneven Bars

Step 24

Steps 26-27

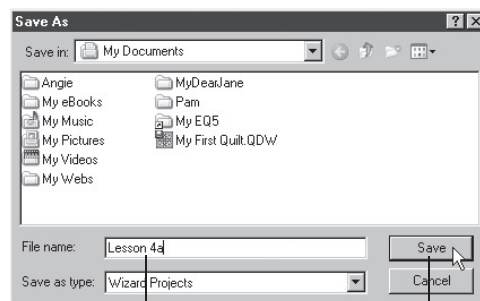

Step 30

Step 31

Quilt Wizard - Lesson 4a.QDW

The project title is displayed at the top of the screen.



Step 32



Step 33

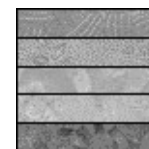

Step 34

Step 35
Rail Fence III

- 36 **Ctrl** + click on any block in the layout.
- 37 Click the **Rotate** tool.
- 38 **Alt** + click on any block in the layout to rotate alternating blocks.

Now let's save this quilt.

- 39 Click the **Save** tool. The *Save As* dialog box displays. The **Save in:** box should still display *My Documents*.
- 40 In the **File name:** box, type **Lesson 4b**.
- 41 Click the **Save** button. You'll see the name of the file on the title bar at the top of the screen.
- 42 Click the **New** tool.
- 43 If you see a message asking if you want to save changes to Lesson 4b, click **Yes**. You'll see the empty layout of a new untitled project.

We've practiced creating new projects and saving them. Now let's practice opening them and making changes.



Tip

If you're familiar with word processing applications, then you know that if you write a letter, save it, and then open it again another time, change it, and press save your original letter will be replaced with the new letter. Quilt Design Wizard™ works in the same way. If you make a quilt, save it, and then open it again another time and change it, your original quilt will be replaced with the new quilt.

- 44 Click the **Open** tool. The *Open* dialog box displays.
- 45 The **Look in:** box displays the folder name you are currently viewing. If you need to, click the down arrow and navigate to the *My Documents* folder and double-click on it to open it.
- 46 Click on **Lesson 4a** to select it.
- 47 Click the **Open** button. The first quilt we designed and saved is back on the screen.

Important: If we make changes to this quilt and click **Save**, the original quilt will be gone. We need to use **Save As** to give this project a new name and then we can make changes.

- 48 Click **File**.
- 49 Click **Save As**. When you want to rename an existing file, be sure to choose **Save As** from the **File** menu and *not* the **Save** tool.
- 50 In the **File name:** typing box, you will see *Lesson 4a*. Change the name to **Lesson 4a Variation**.
- 51 Click the **Save** button. You'll see the name of the file, *Lesson 4a Variation*, on the title bar at the top of the screen.

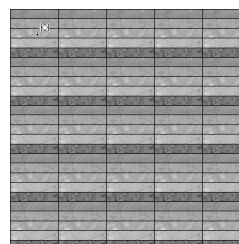

Step 36



Step 37

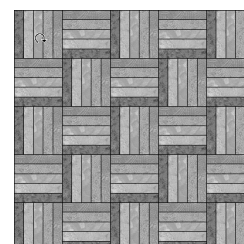

Step 38



Step 39

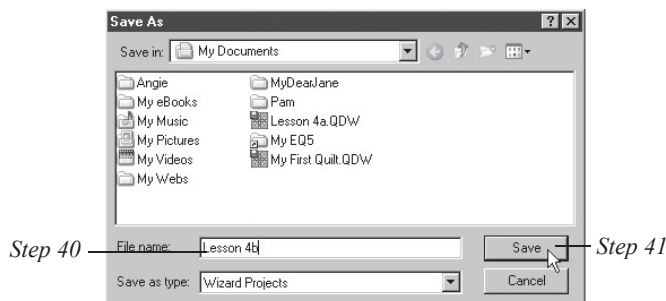

Step 40

Step 41



Step 42



Step 44

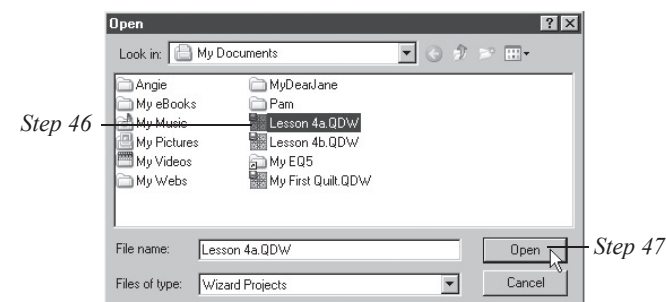

Step 46

Step 47



Steps 48-49

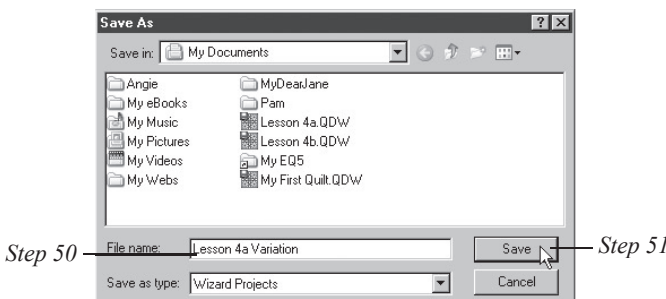

Step 50

Step 51



The project title is displayed at the top of the screen.

Now we are free to make as many changes to this quilt as we want without losing the **Lesson 4a** quilt. Let's learn more about changing an existing quilt.

52 Click the **Layout** tab.

In the other lessons, we were starting a new quilt when we visited the **Layout** tab. Since we have an existing quilt already, you'll notice that the first four controls have *warning arrows* and are labeled **Modified**. Using these controls will *start over* with an empty layout. If you want to make changes to the layout without starting completely over, then use **Tailor this layout style**.

53 Click **Tailor this layout style**. This will open controls to let you change any part of the layout. We'll add sashing to this quilt.

54 Drag the slider for **Sashing Width** to **2.00**.

55 Drag the slider for **Sashing Height** to **2.00**.

Now let's set blocks in the sashing.

56 Click the **Blocks** tab. Whenever you change tabs and come back to this tab, the blocks you see in the palette are the blocks in your project.

57 Click on the *Economy Variation* block to select it.

58 Click the **Set** tool.

59 **Ctrl** + click in the corner squares of the sashing.

60 **Ctrl** + click in any vertical sashing block.

61 **Ctrl** + click in any horizontal sashing block.

Our quilt has taken on a whole new look with pieced sashing added! Let's save it.

62 Click the **Save** tool. You don't see a dialog box this time because our quilt is already named. When you click on the **Save** tool, your computer rewrites the file with the newest information.



Tip

Click the **Save** tool to resave the quilt with the current name. Click **Save As** from the **File** menu to rename the quilt with a different file name.

Let's look at both of our projects again.

63 Click the **Open** tool.

64 If you see a message asking if you want to save changes to **Lesson 4a Variation**, click **Yes**. The *Open* dialog box displays

65 Click on **Lesson 4a** to select it.

66 Click the **Open** button. The first quilt we designed and saved is back on the screen.

67 Click the **Open** tool.

68 Click on **Lesson 4a Variation** to select it.

69 Click the **Open** button. The variation quilt is back on the screen.

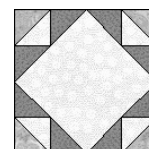
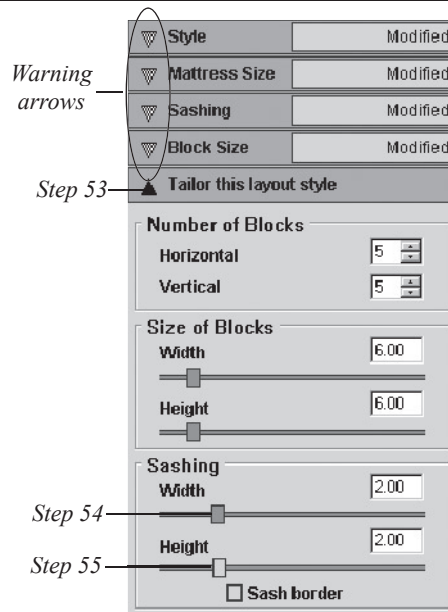

Step 57-Economy Variation



Step 58

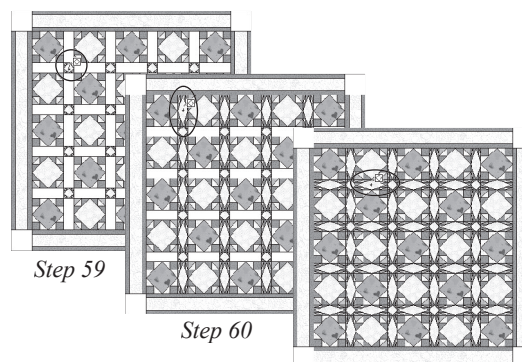

Step 59

Step 60

Step 61



Step 62



Step 63



Step 64

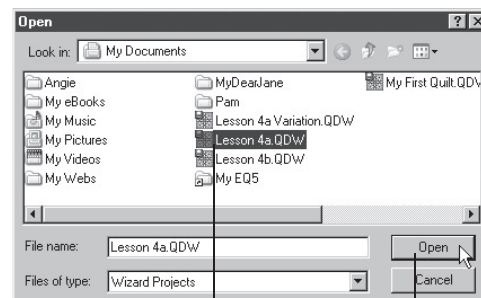

Step 65

Step 66

We'll make one more variation in this lesson.

- 70 Click the **Open** tool.
- 71 Click on **Lesson 4b** to select it.
- 72 Click the **Open** button. You'll remember this quick quilt. Notice the project name on the title bar.
- 73 Click **File**.
- 74 Click **Save As**.
- 75 In the **File name:** box, you will see *Lesson 4b*. Change the name to **Lesson 4b Variation**.
- 76 Click the **Save** button. You'll see the name of the file, *Lesson 4b Variation*, on the title bar at the top of the screen.
- 77 Click the **Layout** tab.

Again you'll notice that the first four controls have *warning arrows* and are labeled **Modified** because we've opened an existing project. Using these controls will *start over* with an empty layout. Let's go again and start over.

- 78 Click on the *warning arrow* next to the word **Style**.
- 79 You'll see a special Wizard message box warning you about starting over.
- 80 Click **Yes**.
- 81 Click on **On-point Medallion**.
- 82 Click **Mattress Size**. Click **Double**.
- 83 Click **Sashing**. Click **Yes**.
- 84 Click **Block Size**. Since it's a medallion style layout, there's only one block size – **32** inches.
- 85 Click the **Borders** tab.
- 86 Click the **Add** button. A border will be added to your layout.
- 87 To change the style, click on the fourth image **Corner Blocks**.
- 88 Click to place a check in **All** if it is not checked already.
- 89 Drag any one of the sliders so that the border is **10.00** inches wide.
- 90 Click the **Blocks** tab. You'll see the *Rail Fence III* block since that block was originally saved in the project.
- 91 Click the **Set** tool.

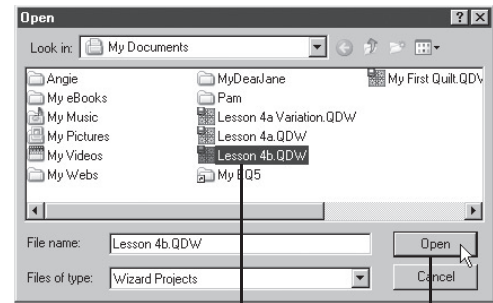

Step 71

Step 72

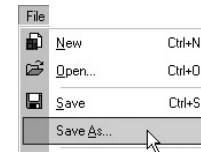

Steps 73-74

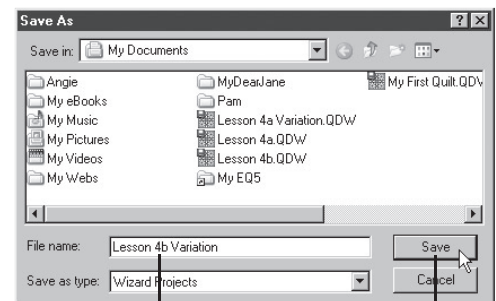

Step 75

Step 76

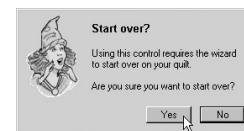

Steps 79-80

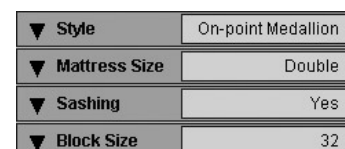

Steps 81-84

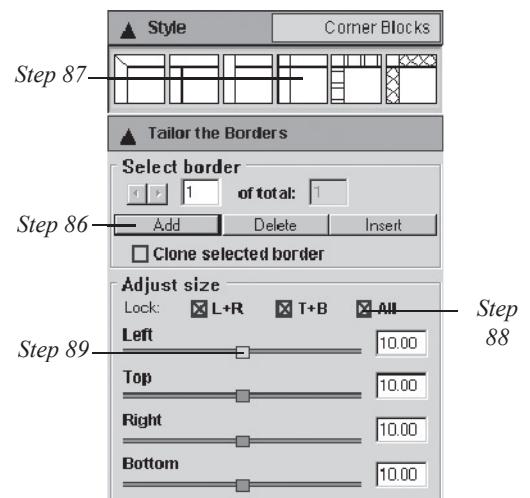

Step 87

Step 86

Step 89

Step 88

- 92 Click on the four sashing locations in the layout to set the *Rail Fence III* block.
- 93 Click on the four long border blocks to set the *Rail Fence III* block in the border.
- 94 Click the **Rotate** tool.
- 95 Click the sashing in the upper right one time. This will rotate the stripes of the *Rail Fence III* block so that the red fabric is on the inside.
- 96 Click the sashing in the lower right two times until the red stripe is on the inside.
- 97 Click the sashing in the lower left three times until the red stripe is on the inside.
- 98 Now click on each of the *Rail Fence III* blocks in the border until the red stripes are all running along the *outside* edge of the quilt.

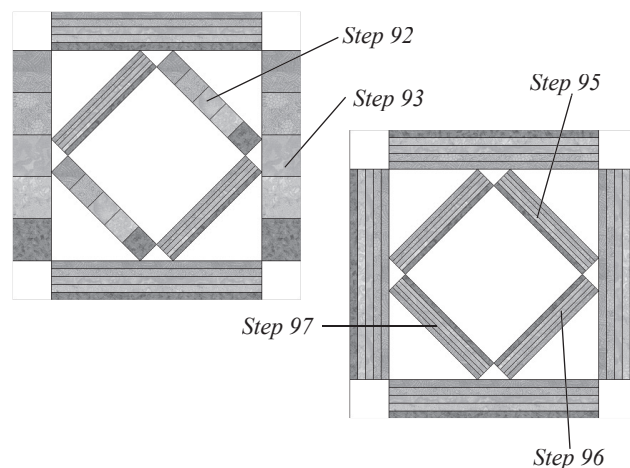

Star blocks work well as a center block in a medallion quilt. Let's get a star block.

- 99 Click **Blocks in the Library**.
- 100 Scroll to the **Stars** category and click to display the blocks.
- 101 Drag the scroll bar to the last block – *Five Patch Star*.
- 102 Click on the *Five Patch Star* block to select it.
- 103 Click the **Set** tool.
- 104 Click on the center block of the layout to set the block.
- 105 **Ctrl** + click on one of the corner squares in the border to set the block in all the corners.
- 106 Click the **Fabrics** tab.
- 107 Click the orange fabric in the top row. These are the fabrics in our project by default. The blocks that come from the library are colored with these fabrics.
- 108 Click the **Paint Quilt** tool.

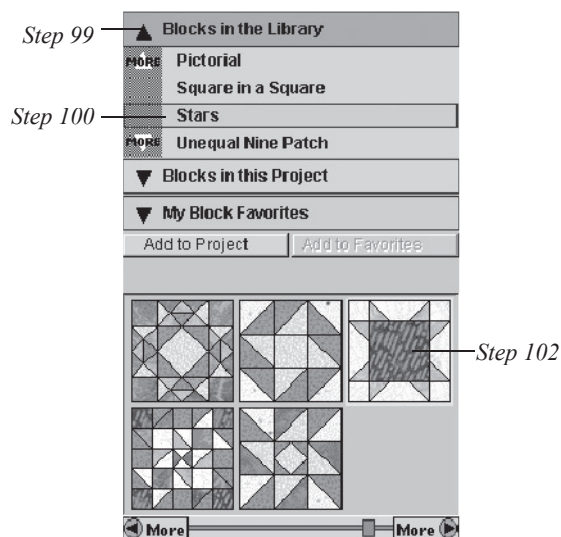

- 109 Click on one of the empty white triangles. This will paint all the empty white patches in the quilt with the same orange fabric.
- 110 Click the **Save** tool. Again, you will not see a dialog box because our project file is already named.

You can continue to make changes to your quilt clicking on **Save** occasionally to keep your most recent changes. Let's make one more change to this quilt. The sashing may look better if we make it wider.

- 111 Click on the **Layout** tab.

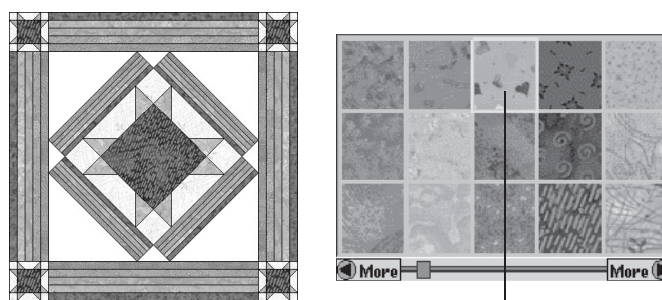

Step 104

Step 107



Step 108

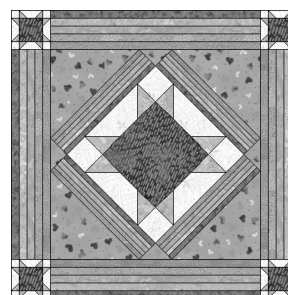

Step 109



Step 110

112 Click on **Tailor this layout style**.

113 Drag the sashing slider up to **10.00** inches.

114 Click the **Blocks** tab. Yes, it looks better.

115 Click the **Save** tool.

Congratulations! You've completed Lesson 4, and you've learned a lot!

- There is one quilt per project file.
- All project files end with .QDW.
- Use **Save As** to rename a project without losing the original.
- Use **Tailor this layout style** to edit an existing quilt without losing the blocks and fabrics already in the quilt.
- The *warning arrows* will force you to start over with an empty quilt layout.

Besides learning about all those features, you've learned how to set and rotate blocks in sashing and borders. In our next lesson we'll make some on-point layouts and practice using the **Borders** tab.

116 Click **File**.

117 Click **Exit**.

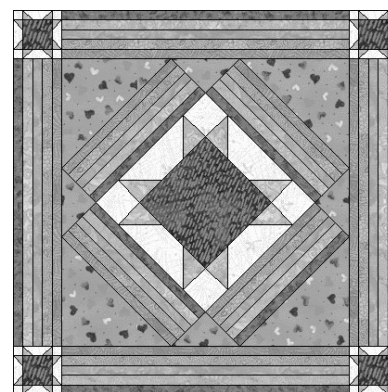
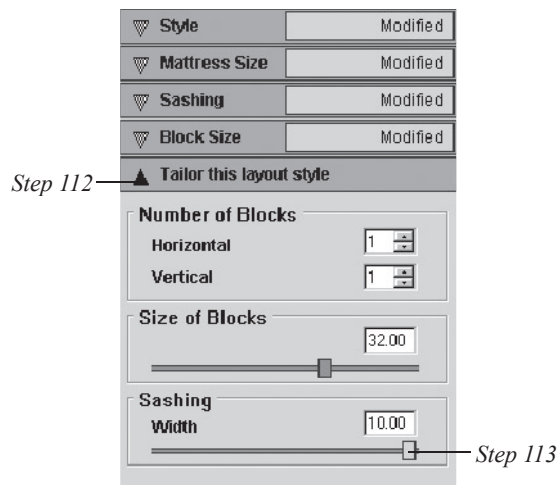

Finished quilt for Lesson 4