

The background of the slide features a photograph of two men in profile, facing right. The man in the foreground is wearing dark sunglasses and has a beard. The man behind him is also wearing glasses and has a beard. The lighting is warm and comes from the left, creating a soft glow. The title text is overlaid on the upper portion of the image.

Lawful Interception of IP Traffic: The European Context

▪Jaya Baloo
▪July 30, 2003

BLACKHAT
Las Vegas, Nevada

Contents

- **Introduction to Lawful Interception**
- **Interception of Internet services**
- **Origins in The European Community**
- **The European Interception Legislation in Brief**
- **ETSI**
- **The Dutch TIIT specifications**
- **Interception Suppliers & Discussion of Techniques**
- **Future Developments & Issues**

Introduction to Lawful Interception

- ETSI definition of (lawful) interception:
 - **interception:** action (based on the law), *performed* by an network operator/access provider/service provider (NWO/AP/SvP), of making available certain information and providing that information to a law enforcement monitoring facility.

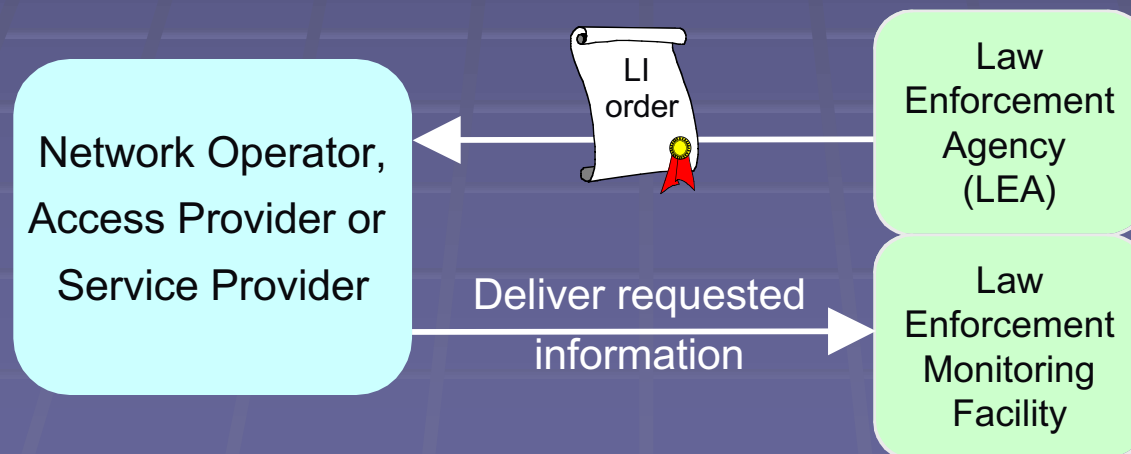

LI's Raison D'etre

- Why intercept?
 - Terrorism
 - Pedophilia rings
 - Cyber stalking
 - Data theft –Industrial espionage
 - Drug dealers on the internet
- Why not?
 - Privacy
 - Security

Legal Issues in LI

- Judge: "Am I not to hear the truth?"
Objecting Counsel: "No, Your Lordship is to hear the evidence."
- Some characteristics of evidence- relevance to LI
 - Admissible – can evidence be considered in court–
*differs per country
 - Authentic – explicitly link data to individuals
 - Accurate – reliability of surveillance process over content of intercept
 - Complete – tells a “complete” story of a particular circumstance
 - Convincing to juries – probative value, and subjective practical test of presentation

Admissibility of Surveillance Evidence

- Virtual Locus Delecti
- Hard to actually find criminals in delicto flagrante
- How to handle expert evidence? Juries are not composed of network specialists. Legal not scientific decision making.
- Case for treating Intercepted evidence as secondary and not primary evidence
 - **Primary** – is the best possible evidence – e.g. in the case of a document – its original.
 - **Secondary** – is clearly not the primary source – e.g. in the case of a document – a copy.

Interception of Internet services

Interception of Internet services

What are defined as Internet services?

- access to the Internet
- the services that go over the Internet, such as:
 - surfing the World Wide Web (e.g. html),
 - e-mail,
 - chat and icq,
 - VoIP, FoIP
 - ftp,
 - telnet

What about encrypted traffic?

- Secure e-mail (e.g. PGP, S/MIME)
 - Secure surfing with HTTPS (e.g. SSL, TLS)
 - VPNs (e.g. IPsec)
 - Encrypted IP Telephony (e.g. pgp -phone and Nautilus)
 - etc.
 - If applied by NWO/AP/SvP then
 - encryption should be stripped before sending to LEMF or
 - key(s) should be made available to LEA
- else
- *a challenge for the LEA*

Logical Overview

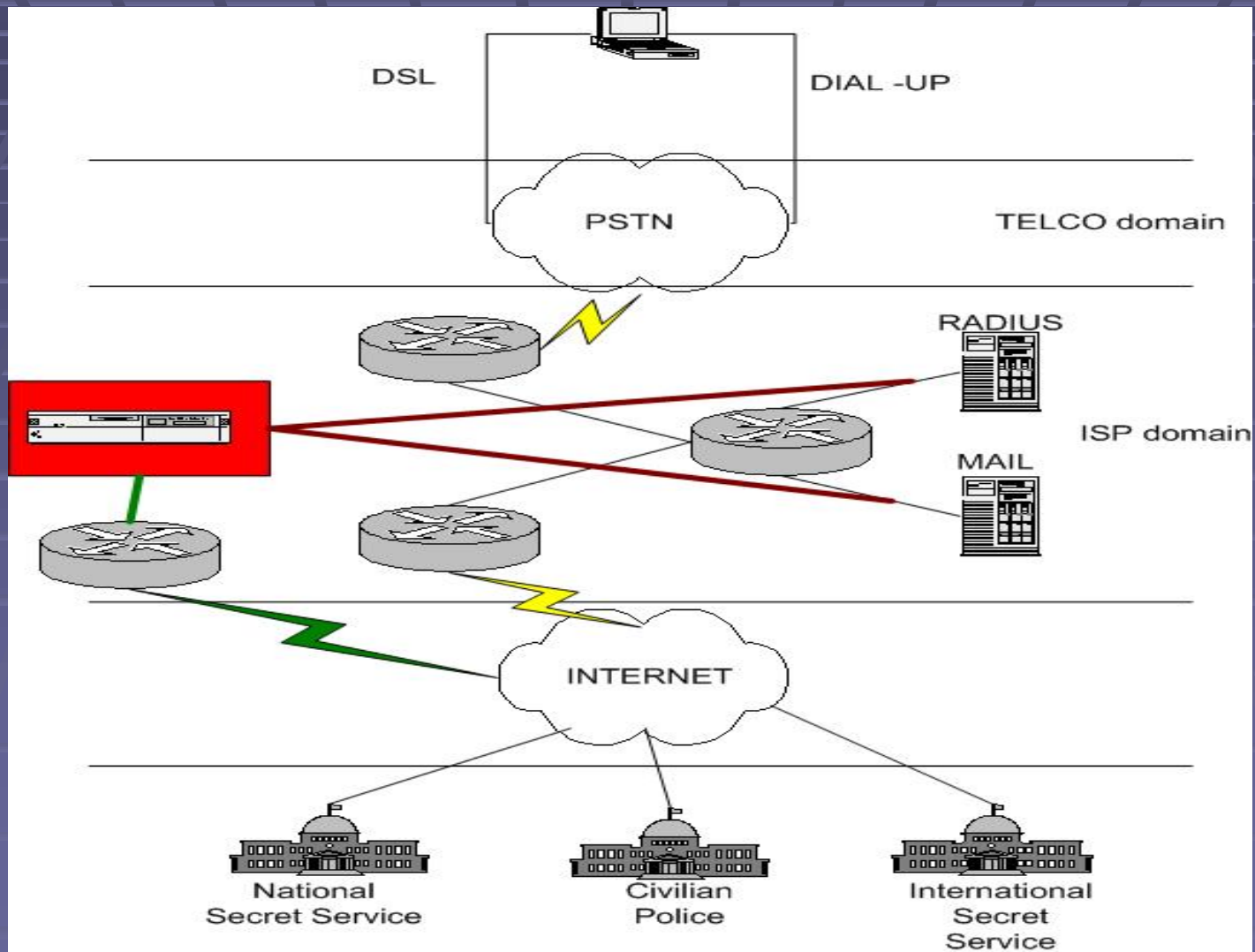

Technical Challenges

- Req. –Maintain Transparency & Standard of Communication
- Identify Target - Monitoring Radius – misses disconnect
- Capture Intercept information – Effective Filtering Switch
- Packet Reassembly
- Software complexity increases bugginess
- Peering with LEMF

Origins in The European Community

What is LI based on in the EU?

- Legal Basis
 - EU directive
 - Convention on Cybercrime – Council of Europe-
 - Article 20- Real time collection of traffic data
 - Article 21- Interception of content data
 - National laws & regulations
- Technically
 - Not Carnivore
 - Not Calea
- Standards, Best Practices based approach
 - IETF's standpoint (RFC 2804 IETF Policy on Wiretapping)

The European Interception Legislation in Brief

Solution Requirements

Country	Obligation permanent solution	Obligation flexible solution	Remarks
France	No	Yes	
Germany	No	Yes	LI for SMS, e-mail, chat
Greece	No	Yes	
Italy	No	Yes	
Netherlands	Yes	Yes	
Portugal	No	Yes	
Spain	No	Yes	
United Kingdom	Yes	No	LI will be a obligation mid 2002

European Interception Legislation

- France
 - Commission Nationale de Contrôle des Interceptions de Sécurité -- La loi 91-636
 - Loi sur la Sécurité Quotidienne – November 2001
- Germany
 - G-10 – 2001- "Gesetz zur Beschränkung des Brief-, Post- und Fernmeldegeheimnisses"
 - The Counter terrorism Act – January 2002

UK Interception Legislation

- **UK**
 - Regulation of Investigatory Powers Act 2000
 - Anti-terrorism, Crime and Security Act 2001
- **“The tragic events in the United States on 11 September 2001 underline the importance of the Service’s work on national security and, in particular, counter-terrorism. Those terrible events significantly raised the stakes in what was a prime area of the Service’s work. It is of the utmost importance that our Security Service is able to maintain its capability against this very real threat, both in terms of staff and in terms of other resources. Part of that falls to legislation and since this website was last updated we have seen the advent of the Regulation of Investigatory Powers Act 2000, Terrorism Act 2000 and the Anti-Terrorism Crime and Security Act 2001. Taken together these Acts provide the Security Service, amongst others, with preventative and investigative capabilities, relevant to the technology of today and matched to the threat from those who would seek to harm or undermine our society. “ – The UK Home Secretary’s Foreword on www.MI5.gov**

The Case in Holland

- At the forefront of LI : both legally & technically
 - The Dutch Telecommunications Act 1998– Operator Responsibilities
 - The Dutch Code of Criminal Proceedings – Initiation and handling of interception request
 - The Special Investigation Powers Act -streamlines criminal investigation methods
 - WETVOORSTEL 20859 – backdoor decree to start fishing expeditions for NAW info – Provider to supply info not normally available
-
- LIO – National Interception Office – in operation since end of 2002
 - CIOT – central bureau for interception for telecom

European Telecommunications Standards Institute

Technical Specs. of Lawful Interception The ETSI model

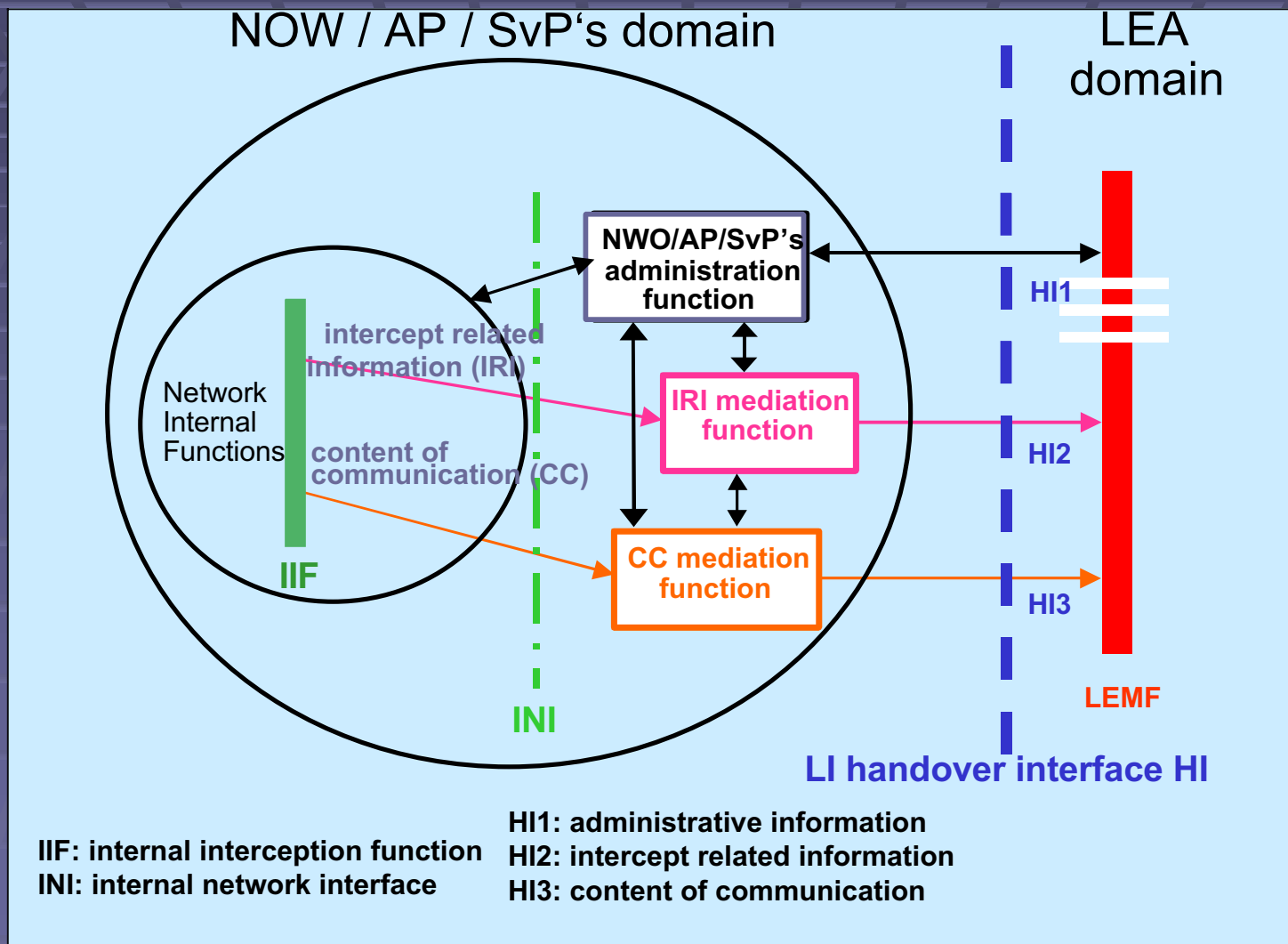

ETSI

- Purpose of ETSI LI standardization – “to facilitate the economic realization of lawful interception that complies with the national and international conventions and legislation “
- Enable Interoperability – Focuses on Handover Protocol
- Formerly ETSI TC SEC LI – working group
- Now ETSI TC LI –separate committee standards docs.
- Handover Spec – IP – expected in 2003-04-01 WI 0030-20
- DTS/LI-00005 – Service specific details for internet access – RADIUS DHCP – etc. how to intercept internet access services – payload
- DTS/LI-00004 – Email specific
- Extras VOIP PPP tunneling – proposals
- IPV6 - integrate in 0005 ?
- Current Status : still in progress
- Comprised primarily of operators and vendors - WG LI
- ETSI TR 101 944 – The Issues

ETSI TR 101 944

- **Responsibility- Lawful Interception requirements must be addressed separately to Access Provider and Service Provider.**
- **5 layer model - Network Level & Service Level division**
- **Implementation Architecture –**
 - Telephone cct. (PSTN/ISDN)
 - Digital Subscriber Line (xDSL)
 - Local Area Network (LAN)
 - Permanent IP Address
- **Security Aspects**
- **HI3 Delivery**

The Dutch TIIT specifications

The TIIT

- WGLI
- The Players
- The End Result V.1.0
- The deadlines – Full IP & Email –2002
- NLIP
- Costs
- ISP Challenge

TIIT

- User (LEA) Requirements for transport
- Description of Handover Interface
 - HI1: method depends on LEA, but also contains crypto keys
 - HI2: events like login, logout, access e-mailbox, etc.
 - HI3: Content of Communication and additional generated information (hash results and NULL packets)
- Description of General Architecture for HI2 and HI3
- Handover Interface specification
 - Global data structures
 - S1 – T2 Traffic Definition
 - Data structures and message flows for HI2 and HI3
 - Use of cryptography

TIIT

General Architecture for HI2 and HI3

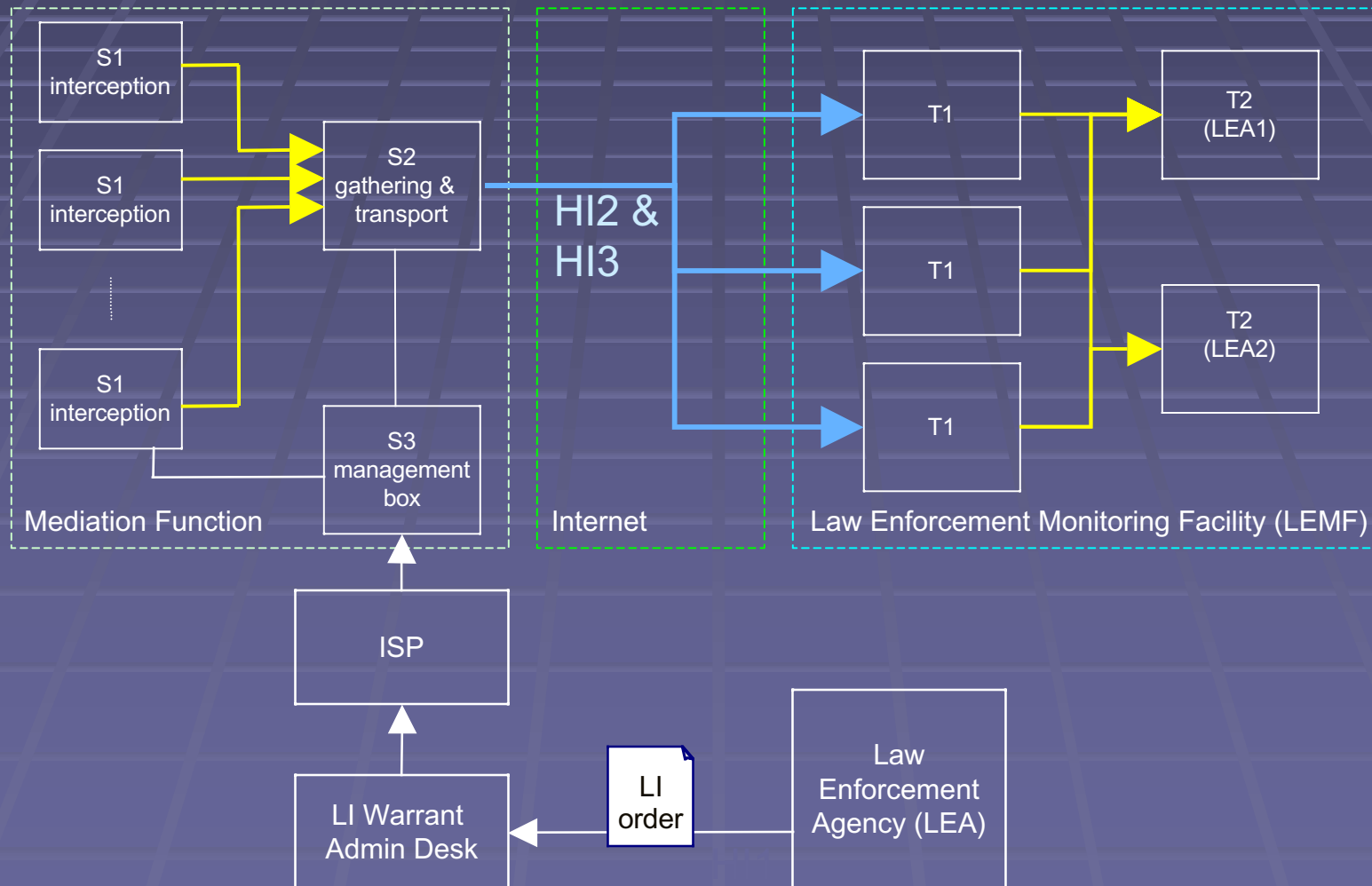

TIIT

General Architecture for HI2 and HI3

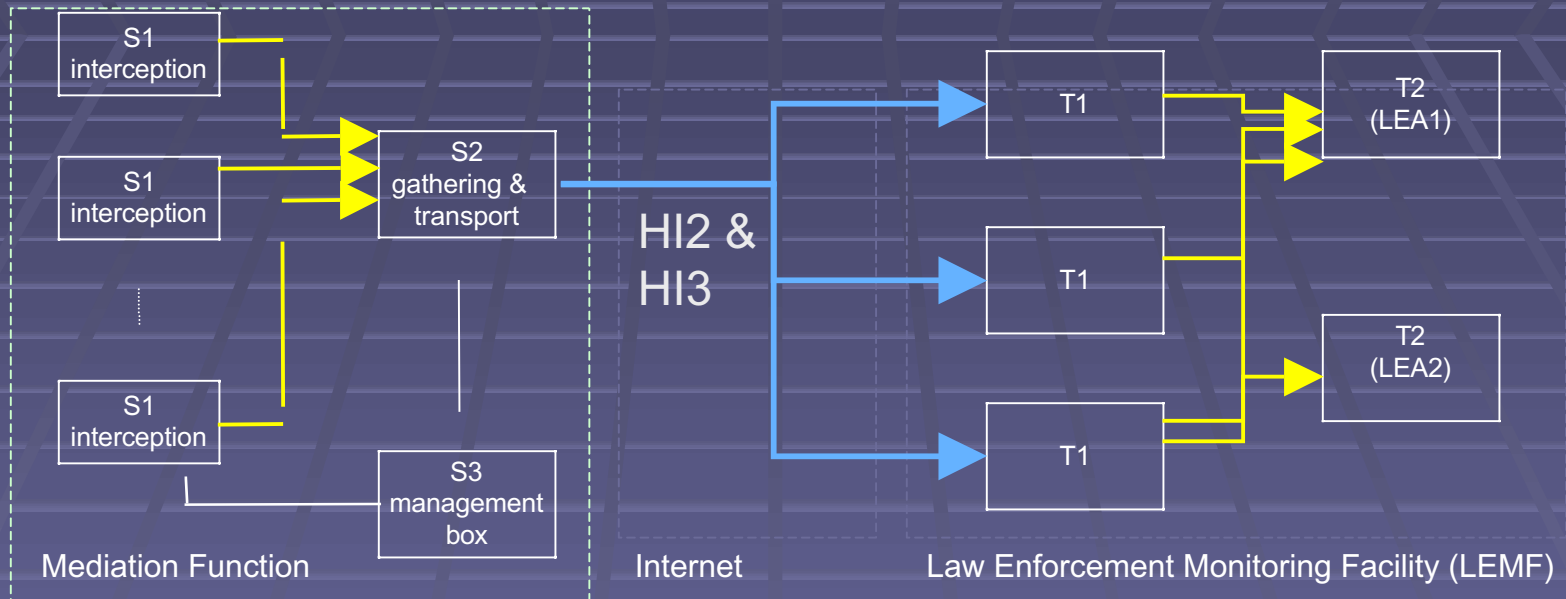

S1:

- Intercept target traffic
- Time stamp target packets
- Generate SHA hash over 64 target packets
- Encrypt with key specific for this interception
- Send to S2

S2:

- Collect target packets from authenticated S1s
- Distribute target packet randomly over the T1s over a TLS or IPsec channel
- Use X.509 certificates for mutual authentication

TIIT - General Architecture for HI2 and HI3

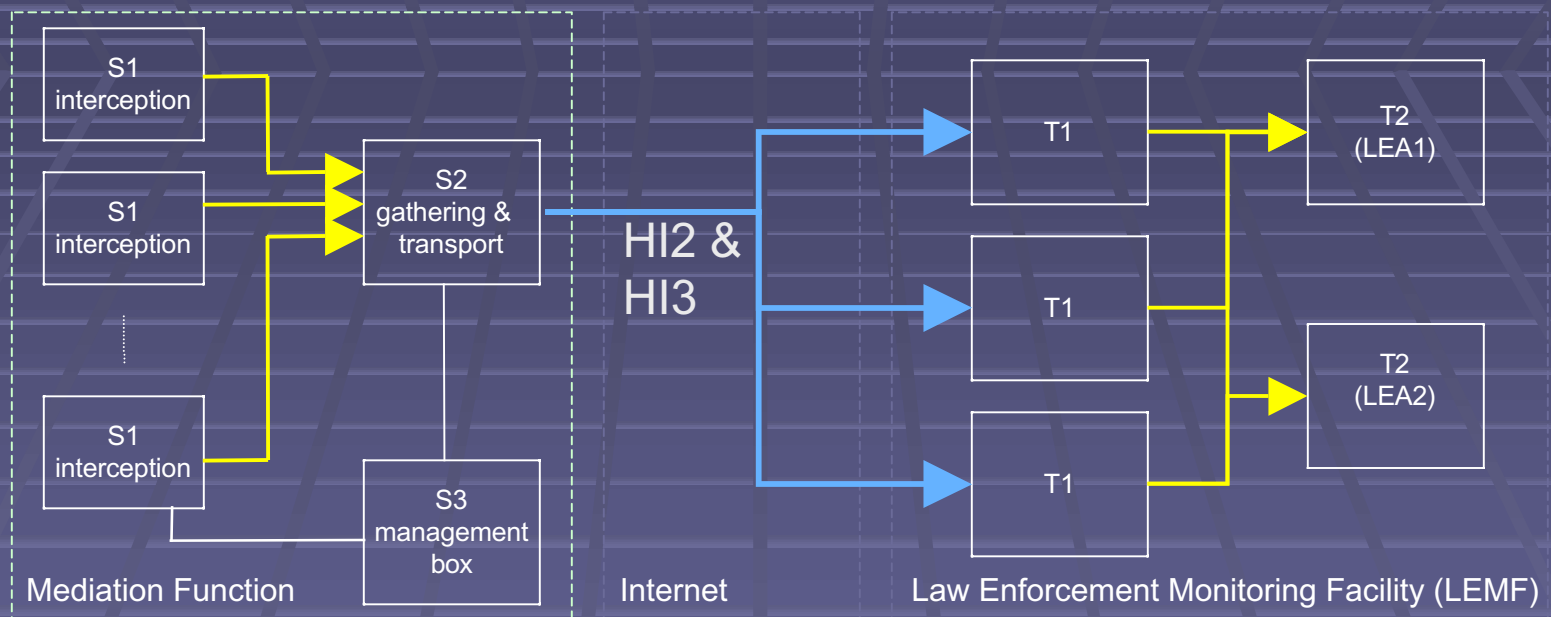

- S3 is not really TIIT
- Management system for
 - Starting & stopping interceptions
 - Collect billing data
 - Etc.

TIIT - General Architecture for HI2 and HI3

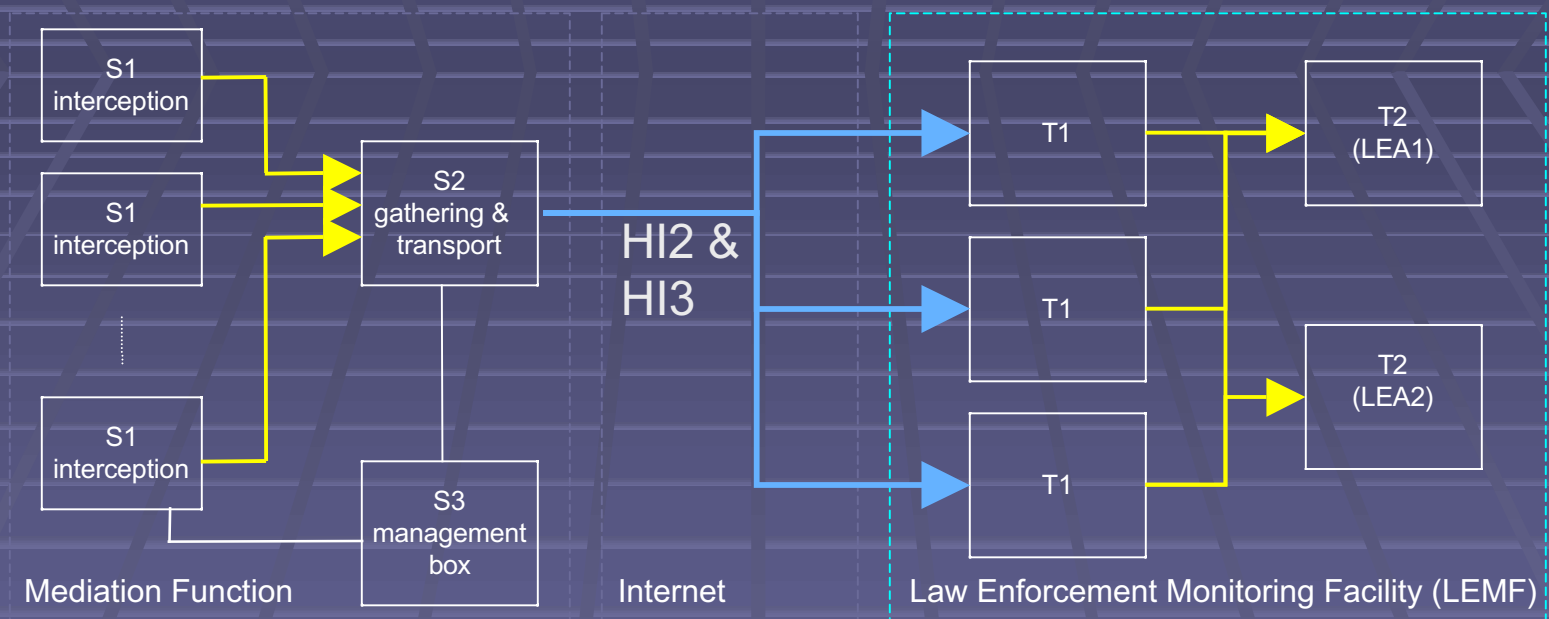

- T1s:
 - End TLS or IPsec channel(s)
 - Forward data to T2(s) of the LEA that ordered the interception
- T2:
 - Decrypt packets from S1s
 - Check integrity

Interception Suppliers & Discussion of Techniques

LI Implementations

- Verint formerly known as Comverse Infosys
- ADC formerly known as SS8
- Accuris
- Pine
- Nice
- Aqsacom
- Digivox

- Telco/ ISP hardware vendors
 - Siemens
 - Alcatel
 - Cisco
 - Nortel

Implementation techniques

- Active- direct local interception – i.e. Bcc:
- Semi-Active- interaction with Radius to capture and filter traffic per IP address
- Passive- no interaction with ISP required only interception point for LEA device

- Most of the following are active or a combination of active and semi-active implementations

Verint = Comverse - Infosys

- Based in Israel – Re : Phrack 58-13
- Used by Dutch LEMF
- Used extensively internationally – supports CALEA & ETSI
- Use of Top Layer switch

- Response

NICE

- Used in BE as t1
- Proprietary – implemented for ETSI
- Feat., topic extraction, Keyword Spotting, Remote Send of CC
- Auto Lang. detection and translation
- Runs on Windows NT & 2000 Svr.
- Stand alone internet/ telephony solution

ADC = SS8

- Use of proprietary hardware
- Used for large bandwidth ccts.
- Known to be used in Satellite Traffic centers
- Supports CALEA – ETSI
- Use of Top Layer switch

Accuris

- Max. of 50 concurrent taps
- Solution not dependant on switch type
- Can use single s2 as concentrator
- Offer Gigabit Solution – but depends on selected switch capability and integration with filter setting
- Supports Calea & ETSI

It's all about the M\$ney

- Solutions can cost anywhere from 100,000 Euro to 700,000 Euro for the ISP
- UK Govt. expected to spend 46 billion over the next 5 years- subsequently reduced to 27 billion
- Division of costs
 - Cap Ex = ISP
 - Op Ex = Govt.
- Penalties for non-compliance
 - Fines – up to 250,000 euros
 - Civil Charges
 - House Arrest of CEO of ISP
- Cooperation between ISPs to choose single LI tool

Conclusions for Law Enforcement

- “If you’re going to do it ... do it right”
 - Disclosure of tools and methods
 - Adherence to warrant submission requirements
 - Completeness of logs and supporting info.
 - Proof of non- contamination of target data
 - Maintaining relationship with the private sector
- Law Enforcement personnel
 - Training
 - Defining role of police investigators
 - Defining role of civilian technicians
 - Handling Multi – Focal investigations

Future Developments & Issues

- EU Expansion – Europol stipulations
- Data Retention Decisions
- ENFOPOL organization
- Borderless LI
- ISP Role
- EU wide agreements on Intercept Initiation
- Quantum Cryptography
- WLAN challenges
- The Future of Privacy Legislation ?

Web Sites

- www.opentap.org
- <http://www.quintessenz.at/cgi-bin/index?funktion=documents>
- www.phrack.com
- www.cryptome.org
- www.statewatch.org
- www.privacy.org
- www.iwar.org.uk
- www.cipherwar.com
- www.cyber-rights.org/interception

Q&A / Discussion

- Does LI deliver added value to Law Enforcement's ability to protect the public?
- What about open source Interception tools?
- Will there be a return of the Clipper Chip?
- Should there be mandated Key Escrow of ISP's encryption keys?
- What types of oversight need to be built into the system to prevent abuse?

Thank You.

Jaya Baloo

jaya@baloos.org

+31-6-51569107