

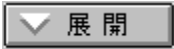







## Microsoft TCP/IP ,lfwf<fv



-  [Microsoft TCP/IP for Windows NT ,lŠT—v](#)
-  [Microsoft TCP/IP ,Æ SNMP ,l'g,ÝŹ,Ý,Æ\Ź—](#)
-  [DHCP fTŹ\[foŹ\[l,Ź'g,ÝŹ,Ý,Æ\Ź—](#)
-  [WINS fTŹ\[foŹ\[l,Ź'g,ÝŹ,Ý,Æ\Ź—](#)
-  [Microsoft FTP fTŹ\[foŹ\[l fTŹ\[frfX,lŽg—p](#)
-  [^óŹü,Æ TCP/IP](#)
-  [fTŹ\[feBfŠfeB,ÆfTŹ\[frfX,lŠftf@fŹf“fX](#)
-  [ŠÖ~AŹŹ•ñ](#)

'Ź : ,±,ê,ç,lŹ€-Ú,l,Ź,Ź,l,Ź,,Â,©,íŹAŹuMicrosoft TCP/IP ,lfwf<fvŹv^ÈŠO,lfwf<fv ftf@fCf<,đ•\ ŽŹ,μ,Ź,ŹBTCP/IP ,lfwf<fv ftf@fCf<,É-Ź,é,É,íŹA[fqfXfjfŠ] fEfBf“fhfE,Å [TCP/IP ,lfwf<fv,l-ÚŽŹ] ,đ'l,Ô,©ŹA,Ź,½,í Microsoft TCP/IP ,lfwf<fv,É-Ź,é,Ź,Å [-Ź,é] f{f^f“,đfNfŠfjbfN,μ,Ź,ŹB



## Microsoft TCP/IP ,lfwf<fv



- Microsoft TCP/IP for Windows NT ,ìŠT—v
- Microsoft TCP/IP ,Æ SNMP ,ì'g,Ý[]ž,Ý,Æ[]\[]—
- TCP/IP ,ì'g,Ý[]ž,Ý,É,Â,ç,Ä
- Microsoft TCP/IP ,ð'g,Ý[]ž,p'O,É
- TCP/IP ,ð'g,Ý[]ž,p
- TCP/IP ,ð[]\[]—,,:.é
- DNS ,ðžg—p,,:.é,½,ß,É TCP/IP ,ð[]\[]—,,:.é
- TCP/IP ,ìÚ[]×fifvfVff“ ,ð[]Ý'è,,:.é
- SNMP ,ð[]\[]—,,:.é
- DHCP fT[]fo[][,ì'g,Ý[]ž,Ý,Æ[]\[]—
- WINS fT[]fo[][,ì'g,Ý[]ž,Ý,Æ[]\[]—
- Microsoft FTP fT[]fo[][ fT[][frfX.lžg—p
- ^ó[]ű,Æ TCP/IP
- ft[][fefBfŠfefB,ÆfT[][frfX,ìfŠftf@fCef“fx
- ŠÖ~A[]î•ñ

'[] : ,±,ê,ç,ì[]€-Ú,ì,α,ζ,ì,ç,,Â,©,í[]A[]uMicrosoft TCP/IP ,lfwf<fv[]v^ÈŠO,lfwf<fv ftf@fCf<,ð•\ Žì,μ,Ü,·[]BTCP/IP ,lfwf<fv ftf@fCf<,É-ß,é,É,í[]A[][fafXfgfŠ] fEfBf“fhfE,Å [TCP/IP ,lfwf<fv,ì-ÚžÝ] ,ð'I,Ô,©[]A,Ü,½,Í Microsoft TCP/IP ,lfwf<fv,É-ß,é,Ü,Å [-ß,é] f{f^f“,ðfNfŠfbfN,μ,Ü,·[]B

## Microsoft TCP/IP ,lfwf<fv



Microsoft TCP/IP for Windows NT ,iŠT—v



Microsoft TCP/IP ,Æ SNMP ,i'g,Ýž,Ý,Æ\□—



DHCP fT□[fo□[ ,i'g,Ýž,Ý,Æ\□—



DHCP fT□[fo□[ ,ižg—p,É,Â,č,Ä



DHCP fNf%ofCfAf“fg fT□[fo□[ f,fff<,iŠT—v



DHCP fT□[fo□[ ,đ'g,Ýž,č,p



WINS fT□[fo□[ ,i'g,Ýž,Ý,Æ\□—



Microsoft FTP fT□[fo□[ fT□[frfX,ižg—p



^ó□ü,Æ TCP/IP



ft□[fefBfŠfefB,ÆfT□[frfX,iŠftf@fCef“fX



ŠÖ~A□î•ñ

'□ : ,±,ê,ç,ì□€-Ú,ì,κ,ž,ì,č,,Â,©,í□A□uMicrosoft TCP/IP ,lfwf<fv□v^ÈŠO,lfwf<fv ftf@fCf<,đ•\  
Ž!,μ,Ü,·□BTCP/IP ,lfwf<fv ftf@fCf<,É-β,é,É,í□A[fqfXfgfŠ] fEfBf“fhfE,Ä [TCP/IP ,lfwf<fv,ì-ÚŽŸ]  
,đ'l,Ö,©□A,Ü,½,í Microsoft TCP/IP ,lfwf<fv,É-β,é,Ü,Ä [-β,é] f{f^f“ ,đfNfŠfbfN,μ,Ü,·□B

## Microsoft TCP/IP ,lfwf<fv



Microsoft TCP/IP for Windows NT ,iŠT—v



Microsoft TCP/IP ,Æ SNMP ,i'g,Ýž,Ý,Æ\□□⇒



DHCP fT□[fo□[ ,i'g,Ýž,Ý,Æ\□□⇒



WINS

WINS fT□[fo□[ ,i'g,Ýž,Ý,Æ\□□⇒



WINS fT□[fo□[ ,ižg—p,É,Â,č,Ä



WINS fT□[fo□[ ,đ'g,Ýž,č



WINS ,i—~“



Microsoft FTP fT□[fo□[ fT□[frfX,ižg—p



^ó□ü,Æ TCP/IP



ft□[fefBfŠfefB,ÆfT□[frfX,iŠftf@fĈf“fX



ŠÖ~A□i•ñ

'□ : ,±,ê,ç,ì□€-Ú,ì,ı,ž,ì,č,,Â,©,í□A□uMicrosoft TCP/IP ,lfwf<fv□v^ÈŠO,lfwf<fv ftf@fCf<,đ•\ Ž!,μ,Ü,·□BTCP/IP ,lfwf<fv ftf@fCf<,É-β,é,É,í□A[fqfXfgfŠ] fEfBf“fhfE,Ä [TCP/IP ,lfwf<fv,ì-ÚŽŸ] ,đ'l,Ö,©□A,Ü,½,í Microsoft TCP/IP ,lfwf<fv,É-β,é,Ü,Ä [-β,é] f{f^f“ ,đfNfŠfbfN,μ,Ü,·□B



## Microsoft TCP/IP ,lfwf<fv



Microsoft TCP/IP for Windows NT ,iŠT—v



Microsoft TCP/IP ,Æ SNMP ,i'g,Ýž,Ý,Æ\□□→



DHCP f□□[fo□□[ ,i'g,Ýž,Ý,Æ\□□→



WINS f□□[fo□□[ ,i'g,Ýž,Ý,Æ\□□→



Microsoft FTP f□□[fo□□[ f□□[frfX, iŽg—p



^ó□ü,Æ TCP/IP



TCP/IP ^ó□ü,É,Â,č,Ä



TCP/IP ^ó□ü, iŠT—v



TCP/IP ^ó□ü, i, ½, ß Windows NT ,đfZfbfgfAfbfv, : , é



TCP/IP ^ó□ü, i, ½, ß, ÉfvfŠf“f^ ,đ□□→ , : , é



f□□[fefBfŠfefB,Æf□□[frfX, ifŠftf@fÆf“fX



ŠÖ~A□î•ñ

'□ : , ±, ê, ç, i□€-Ú, i, x, z, i, č, , Á, ©, í□A□uMicrosoft TCP/IP ,lfwf<fv□v^ÈŠO,lfwf<fv ftf@fCf<,đ•\ Ži, μ, Ů, ·□BTCP/IP ,lfwf<fv ftf@fCf<,É-ß,é,É,í□A[fqfXfgfŠ] fEfBf“fhfE,Å [TCP/IP ,lfwf<fv, i-ÚŽŸ] ,đ'l, Ō, ©□A, Ů, ½, í Microsoft TCP/IP ,lfwf<fv,É-ß,é,Ů, Å [-ß,é] f{f^f“ ,đfNfŠfbfN, μ, Ů, ·□B

## Microsoft TCP/IP ,lfwf<fv



Microsoft TCP/IP for Windows NT ,iŠT—v



Microsoft TCP/IP ,Æ SNMP ,i'g,Ýž,Ý,Æ\□□⇒



DHCP fT□[fo□[ ,i'g,Ýž,Ý,Æ\□□⇒



WINS fT□[fo□[ ,i'g,Ýž,Ý,Æ\□□⇒



Microsoft FTP fT□[fo□[ fT□[frfX, iŽg—p



^ó□ü,Æ TCP/IP



ft□[fefBfŠfefB,ÆfT□[frfX,lfŠftf@fCef“fX



TCP/IP ft□[fefBfŠfefB,É,Â,č,Ä



TCP/IP ft□[fefBfŠfefB



TCP/IP fT□[frfX



TCP/IP □'ff□[fefBfŠfefB,É,æ,égf%ofuf<Vf...□[fefBf“fO



ŠÖ~A□î•ñ

'□ : ,±,ê,ç,ì□€-Ú,ì,κ,ι,ι,ç,,Á,©,í□A□uMicrosoft TCP/IP ,lfwf<fv□v^ÈŠO,lfwf<fv ftf@fCf<,đ•\  
Ži,μ,Û,·□BTCP/IP ,lfwf<fv ftf@fCf<,É-β,é,É,í□A[faqXfgfŠ] fEfBf“fhfE,Å [TCP/IP ,lfwf<fv,ì-ÚŽŸ]  
,đ'l,Ô,©□A,Û,½,í Microsoft TCP/IP ,lfwf<fv,É-β,é,Û,Å [-β,é] f{f^f“,đfNfŠfbfN,μ,Û,·□B



## Microsoft TCP/IP ,lfwf<fv



Microsoft TCP/IP for Windows NT ,iŠT—v



Microsoft TCP/IP ,Æ SNMP ,i'g,Ýž,Ý,Æ\□□→



DHCP f□□[fo□□[ ,i'g,Ýž,Ý,Æ\□□→



WINS f□□[fo□□[ ,i'g,Ýž,Ý,Æ\□□→



Microsoft FTP f□□[fo□□[ f□□[frfX,iŽg—p



^ó□ü,Æ TCP/IP



f□□[fefBfŠfefB,Æf□□[frfX,iŠftf@fCef“fX



ŠÖ~A□î•ñ



ŠÖ~A□î•ñ,i“üŽè



Windows NT ,i MIB flfufWfFfNfg f^fCfv



LMHOSTS ,i□Ý'è



TCP/IP f□□[frfX,Å,lfpftfH□□[f}f“fX f.fif^,iŽg—p





















































,±,lfŠfŠ□□[fX,i□V,μ,č<@“\

'□ : ,±,ê,ç,i□€-Ú,i,α,ζ,i,ç,,Å,©,í□A□uMicrosoft TCP/IP ,lfwf<fv□v^ÈŠO,lfwf<fv ftf@fCf<,đ•\  
Ži,μ,Ü,·□BTCP/IP ,lfwf<fv ftf@fCf<,É-β,é,É,í□A[faqXfgfŠ] fEfBf“fhfE,Å [TCP/IP ,lfwf<fv,i-ÚŽŸ]  
,đ'I,Ô,©□A,Ü,½,í Microsoft TCP/IP ,lfwf<fv,É-β,é,Ü,Å [-β,é] f{f^f“,đfNfŠfbfN,μ,Ü,·□B

## Microsoft TCP/IP ,ìfwf<fv



-  [Microsoft TCP/IP for Windows NT ,ìŠT—v](#)
-  [TCP/IP for Windows NT ,É,Â,ç,Ä](#)
-  [TCP/IP for Windows NT ,Æ,Í](#)
-  [Microsoft TCP/IP ,ì\□□→v'f](#)
-  [TCP/IP flfbfgf□□\[fN,É,“, ,é Windows NT ,ìfŠf...□\[fvf#f“](#)
-  [TCP/IP ,ìflfbfgf□□\[fNŠT”O](#)
-  [Internet fv□fgfRf<'ìCEn](#)
-  [IP fAfhfCefXŽw'è](#)
-  [DHCP](#)
-  [WINS ,Æ Windows flfbfgf□□\[fN,ì-¼'O%øðCE^](#)
-  [SNMP](#)
-  [TCP/IP ,Æ Windows NT flfbfgf□□\[fN](#)
-  [Microsoft TCP/IP ,Æ SNMP ,ì'g,Ý□ž,Ý,Æ□□□→](#)
-  [TCP/IP ,ì'g,Ý□ž,Ý,É,Â,ç,Ä](#)
-  [Microsoft TCP/IP ,ð'g,Ý□ž,p'O,É](#)
-  [TCP/IP ,ð'g,Ý□ž,p](#)
-  [TCP/IP ,ð□□□→, : ,é](#)
-  [DNS ,ðžg—p, : ,é,½,ß,É TCP/IP ,ð□□□→, : ,é](#)
-  [TCP/IP ,ì□Ú□×flfvfVf#f“ ,ð□Ý'è, : ,é](#)
-  [SNMP ,ð□□□→, : ,é](#)
-  [DHCP fT□\[fo□\[ ,ì'g,Ý□ž,Ý,Æ□□□→](#)
-  [DHCP fT□\[fo□\[ ,ìžg—p,É,Â,ç,Ä](#)
-  [DHCP fNf%ofCfAf“fg fT□\[fo□\[ f,fff<,ìŠT—v](#)
-  [DHCP fT□\[fo□\[ ,ð'g,Ý□ž,p](#)
-  [WINS fT□\[fo□\[ ,ì'g,Ý□ž,Ý,Æ□□□→](#)
-  [WINS fT□\[fo□\[ ,ìžg—p,É,Â,ç,Ä](#)
-  [WINS fT□\[fo□\[ ,ð'g,Ý□ž,p](#)
-  [WINS ,ì—~“](#)
-  [Microsoft FTP fT□\[fo□\[ fT□\[frfX,ìžg—p](#)
-  [FTP fT□\[fo□\[ fT□\[frfX,É,Â,ç,Ä](#)
-  [FTP fT□\[fo□\[ fT□\[frfX,ð'g,Ý□ž,p](#)

-  [FTP fT\[\]fo\[\] fT\[\]\[frfX,ð\[\]\\[\]-\[\],.é](#)
-  [FTP fT\[\]fo\[\] fT\[\]\[frfX,ðŠÇ-\[\],.é](#)
-  [FTP fT\[\]fo\[\] fT\[\]\[frfX,ì\[\]Ú\[\]x,È\[\]\\[\]-\[\]pf%\[\]f\[\]f^](#)
-  [^ó\[\]ü,Æ TCP/IP](#)
-  [TCP/IP ^ó\[\]ü,É,Â,ç,Ä](#)
-  [TCP/IP ^ó\[\]ü,ìŠT-v](#)
-  [TCP/IP ^ó\[\]ü,ì,½,ß Windows NT,ðfZfbfgfAfbfv,.é](#)
-  [TCP/IP ^ó\[\]ü,ì,½,ß,ÉfvfŠf“f^,ð\[\]\\[\]-\[\],.é](#)
-  [C:> ft\[\]\[fefBfŠfefB,ÆfT\[\]\[frfX,ìfŠftf@fÇf“fX](#)
-  [TCP/IP ft\[\]\[fefBfŠfefB,É,Â,ç,Ä](#)
-  [TCP/IP ft\[\]\[fefBfŠfefB](#)
-  [TCP/IP fT\[\]\[frfX](#)
-  [TCP/IP \[\]'fft\[\]\[fefBfŠfefB,É,æ,éfgf%\[\]fuf<fvf...\[\]\[fefBf“fO](#)
-  [ŠÖ~A\[\]î•ñ](#)
-  [ŠÖ~A\[\]î•ñ,ì“üŽè](#)
-  [Windows NT,ì MIB flfufWfFfNfg f^fCfv](#)
-  [LMHOSTS,ì\[\]Ý'è](#)
-  [TCP/IP fT\[\]\[frfX,Å,ìfpftfH\[\]\[f}f“fX f.fjf^,ìŽg-p](#)
-  [,±,ìfŠfŠ\[\]\[fX,ì\[\]V,μ,ç<@“\](#)

'[] : ,±,è,ç,ì[]€-Ú,ì,κ,ζ,ì,ç,,Å,©,í[]A[]uMicrosoft TCP/IP ,ìfwf<fv[]v^ÈŠO,ìfwf<fv ftf@fCf<,ð•\ Žì,μ,Ü,·[]BTCP/IP ,ìfwf<fv ftf@fCf<,É-ß,é,É,í[]A[][fafXfgfŠ] fEfBf“fhfE,Å [TCP/IP ,ìfwf<fv,ì-ÚŽÝ] ,ð'I,Ô,©[]A,Ü,½,Í Microsoft TCP/IP ,ìfwf<fv,É-ß,é,Ü,Å [-ß,é] f{f^f“,ðfNfŠfbfN,μ,Ü,·[]B

## TCP/IP ft [fefBfŠfefB,É,Â,č,Ä

Windows NT TCP/IP ft [fefBfŠfefB,Ä,í [A'¼,lfVfXfef€Ö,ìÚ' ± AfIfbfgf [fNŠÇ— [A,“,æ,Ñfgf %ofuf<fvf... [fefBf“fO,ì,½,ß,ìff'ffvfOf%of€ÆfRfIfNfefBfrefefB fc [f< ,đ'ň<Ÿ,μ,Ä,č,Ü,· [B

## TCP/IP ft [fefBfŠfefB,lfwf<fv,đŽQ [Æ,·,é,É,í

- ▶ fRf}f“fh fvf [f“fvfg,Á [Aping -? ,ì,æ,α,É [ATCP/IP ft [fefBfŠfefB,ì-¼'O,“,æ,Ñ -? ,đ“ü—í,μ,Ü,· [B - ,Ü,½,í -
- 1. fvf [Of%of€ f}f [fWff fOf< [fv,ì [Windows NT ,lfwf<fv] fAfCfRf“,đf\_fuf<fNfŠfbfN,μ,Ü,· [B
- 2. [Windows NT ,lfwf<fv] ,ì-ÚŽŸEfBf“fhfE,Á [Windows NT fRf}f“fh] ,ì%º,ì [fRf}f“fh fŠtf@fCf“fX] ,đf\_fuf<fNfŠfbfN,μ,Ü,· [B
- 3. [fRf}f“fh] fEfBf“fhfE,ÁfRf}f“fh-¼,đfNfŠfbfN,·,é,© [A,Ü,½,í [fRf}f“fh fŠtf@fCf“fX] fEfBf“fhfE,ì [CËŸ [ö] f {f^f“,đfNfŠfbfN,μ [AfL [f [fh,©,čfRf}f“fh-¼,đCËŸ [ö,μ,Ü,· [B

qd—v : **ftp** [Aftpsvc [Arexec [A,“,æ,Ñ **telnet** ft [fefBfŠfefB,í [AfŠf, [fg fRf“fsf... [f^,É,æ,éfpfX [fh“F [Ø,É'S-É^É^ [l,μ,Ä,č,Ü,· [B,± ,é,ç,ìft [fefBfŠfefB,í [Af+ [fU [ ,lfAfjEf“fg-¼,“,æ,ÑfpfX [fh,đfIfbfg [fN,ÉfNfŠfA fefLfXfg,Æ,μ,Ä“n,μ,Ü,· [BfIfbfg [fN fAfif%ofCfU,đ“ö,!,½ft [fU [ ,í [A,Ü,©,ìft [fU [ ,lfŠf, [fg fAfjEf“fg fpfX [fh,đ“üŽè,Á,« ,é%ºÁ^ [ [ ,è,Ü,· [B,±,é,ç,ìft [fefBfŠfefB,ìft [fU [ ,í [AWindows NT ,Éf [OfIf“ ,·,é,Æ,« ,í [AfZfLf...fŠfefB<@“\ ,ì,È,čfIfbfg [fN,Éf [OfIf“ ,·,é,Æ,« ,ÉŽg,Á,½fpfX [fh,Æ““ ,lfpfX [fh,đŽg—p,μ,È,č,æ,α,É,μ,Ä,- ,¾,¾,č [BWindows NT ,“,æ,Ñ LAN Manager fIfbfg [fN,ÁŽg— p,¾,¾,è,é [OfIf“ ,ì,½,ß,lfAfjEf“fg [i•ň,í [AfIfbfg [fN,É'—,ç,è,é'O,É,Ä,È,É^ [t%º» ,¾,è,Ü,· [B

















ŠÖ~A [€-Ú

TCP/IP ft [fefBfŠfefB





TCP/IP ft [frfX

TCP/IP [ffft [fefBfŠfefB,É,æ,éfgf%ofuf<fvf... [fefBf“fO

## TCP/IP fT [fefeBfŠfefB

- |   |  |
|---|--|
|  <u>arp</u>      |  <u>ping</u>    |
|  <u>finger</u>   |  <u>rcp</u>     |
|  <u>ftp</u>      |  <u>rexec</u>   |
|  <u>hostname</u> |  <u>route</u>   |
|  <u>ipconfig</u> |  <u>rsh</u>     |
|  <u>lpq</u>      |  <u>telnet</u>  |
|  <u>lpr</u>      |  <u>tftp</u>    |
|  <u>nbtstat</u>  |  <u>tracert</u> |
|  <u>netstat</u>  |  |

## TCP/IP fT [frfX

-  net start lpdsvc
-  net start netbt
-  net start snmp
-  net start tcpip

## TCP/IP for Windows NT ,É,Â,ç,Ä

Microsoft TCP/IP for Windows NT ,É,æ,æ,±,»□B

TCP/IP (Transmission Control Protocol/Internet Protocol; “`—□§CEäfvf□fgfRf</fCf“f^□[flfbfg fvf□fgfRf<)  
,Í□A‘ŠCEÝ,É□Ú±,³,ê,½flfbfgf□□[fNŠÔ,ì‘É□M,ð%oÅ“\,É,·,éflfbfgf□□[fN fvf□fgfRf<,Å,·□B,±,lfwf<fv  
ftf@fCf<,Í□AMicrosoft Windows NT flfyfCE□[fefBf“fOjVfXfef€,ðŽÀ□s,·,éfRf“fsf...□[f^□ä,Å,ì Microsoft  
TCP/IP ,ì‘g,Ý□ž,Ý□A□\□-□A,“ ,æ,Ñfgf%ofuf<fvf...□[fefBf“fO,ì•û-@,É,Â,ç,Ä□à-¾,µ,Ä,ç,Ü,·□B,Ü,½□ATCP/IP  
ft□[fefBfŠfefB,ì□à-¾□A,“ ,æ,Ñ FTP (File Transfer Protocol; ftf@fCf<“]’—fvf□fgfRf<)  
ft□[fo□[ ft□[frfX□ATCP/IP ^ó□ü□ASNMP (Simple Network Management Protocol; ŠÉ^Öflfbfgf□□[fNŠÇ—  
□fvf□fgfRf<) ft□[fefBfŠfefB,È,Ç□A,» ,ì,Ü,©,ì TCP/IP ft□[frfX,ì‘g,Ý□ž,Ý,ÆŽg,ç•û,É,Â,ç,Ä,à□à-¾,µ,Ä,ç  
,Ü,·□B

,±,lfwf<fv,Í□AMicrosoft Windows NT flfyfCE□[fefBf“fO jVfXfef€,ð—□%oð,µ,Ä,ç,éft□[fU□[ ,ð‘z‘è,µ,Ä,ç  
,Ü,·□B,±,ì□»•i,É,Â,ç,Ä□•²,É—□%oð,³,ê,Ä,ç,È,ç□è□‡,Í□AMicrosoft Windows NT ,lf}jff...fAf<,ðŽQ□Æ,µ,Ä,-  
,¾,³,ç□B

TCP/IP ,Í□A‘½—l,Èfn□[fhfEfFfA fA□[flLfefNf`ff,ÆflfyfCE□[fefBf“fO jVfXfef€,ðŽ□,ÅfRf“fsf...□[f^ ,©,ç□  
□- ,³,ê,é□A‘ŠCEÝ,É□Ú±,³,ê,½flfbfgf□□[fNŠÔ,ì‘É□M,ð%oÅ“\,É,·,éflfbfgf□□[fN fvf□fgfRf<,Å,·□BTCP/IP  
,Í□AWindows NT ŠÔ,ì‘É□M,ÉŽg—p,Å,« ,é,¾, -, Å,È,□A,Ü,©,ì Microsoft flfbfgf□□[fN□»•i,ðŽg—  
p,·,é<@Ší,à□AUNIX ,È,Ç Microsoft □»•i,Å,ì,È,çVfXfef€,Æ,ì‘É□M,ÉŽg—p,·,é,±,Æ,à,Å,« ,Ü,·□B

ŠÖ~A□€-Ú

TCP/IP for Windows NT ,Æ,Í

Microsoft TCP/IP ,ì□\□-v‘f

TCP/IP flfbfgf□□[fN,É,“ , ,é Windows NT ,lfŠf...□[fvf†f“

## TCP/IP for Windows NT ,Æ,Í

TCP/IP fvf[]fgfRf< ftf@f~fŠ,Í[]Aflfbfgf[]fN[]ä,lfRf“fsf...[]f^ŠÔ,Áff[]f^,ª,Ç,ì,æ,ª  
,É“n,³,è,é,©,ð[]\$CEà,·,éflfbfgf[]fN,ì<K'¥[]A,·,É,í,¿fvf[]fgfRf<,ì•W[]€fZfbfg,Á,·[]BTCP/IP ,Í[]AInternet ,ì[]Ú'±  
,ÉŽg—p,³,è,Ä,ç,Û,·[]BInternet ,Í[]A[]çŠE“Í,É<K-Í,lfCf“f^[]flfbfgf[]fN,Á, ,è[]A200 -  
æ,ð' ,ì,é'âŠw[]ACEª<†Š[]A•Ä[]',ì-h%oqZ{[]Y[]A,“ ,æ,ÑŠé<Æ,ð[]Ú'±,μ,Ä,ç,Û,· (,±,ì[]çŠE<K-  
Í,lfCf“f^[]flfbfgf[]fN,ðŽw,·,Æ,«,Í[]A[]gInternet[]h,Æ•\<L,μ,Û,·)[]B,±,ì Internet  
,Æ“ ,¶lfvf[]fgfRf<€EQ,ð[]A•;[]",lf[][]fj< fGfŠfA flfbfgf[]fN,ð[]Ú'±,·,évf  
%ofCfx[]fg,ÉfCf“f^[]flfbfgf[]fN,ÉŽg—p,·,é,±,Æ,ª,Ä,«,Û,·[]B

Microsoft TCP/IP for Windows NT ,Æ Windows NT fx[]fX,lfRf“fsf...[]f^,ð~—p,·,é,±  
,Æ,É,æ,è[]AŠé<Æflfbfgf[]fN,ì[]\z,ª%oÄ“\,É,È,è,Û,·[]BWindows NT ,ì[]\[]~É TCP/IP ,ð%oÄ,ì,é,±,Æ,É,æ,é  
—~“ ,ì[]AZÿ,ì,æ,ª,È,à,ì,Ä,·[]B

- TCP/IP ,Í[]A[]Ä,àŠ@[]~ ,μ•<y,μ,Ä,ç,é[]A•W[]€,lf<[]f[]efBf“fo%oÄ“\,ÉŠé<Æflfbfgf[]fN  
fvf[]fgfRf<,Á,·[]BCE»'â“Í,ÉflfyfC[]f[]efBf“fo fVfXfef€,Í,·,x,Á[]ATCP/IP ,ðftfj[]fg,μ,Ä,“ ,è[]A,Û,Æ,ñ,Ç,ì'â<K-  
Íflfbfgf[]fN,ª[]Aflfbfgf[]fN fgf%oftfBfbfN,ì'½,,ì”•ª,ð TCP/IP ,É^É'¶,μ,Ä,ç,Û,·[]B
- ^ÚžifVfXfef€,É[]Ú'±,·,é<Z[]p,ª'ñ<ÿ,³,è,Û,·[]B^ÚžifVfXfef€ŠÔ,Áff[]f^,ÉfAfnfzfx,μ[]A“]’—,Á,«,é'½,-  
,ì•W[]€[]Ú'±ft[]f[]efBfŠfefB,ð~—p,Á,«,Û,·[]B,±,è,É,Í[]A,½,Æ,ì,Í[]AFTP (File Transfer Protocol; ftf@fCf<“]’—  
fvf[]fgfRf<) ,â Telnet (Terminal Emulation Protocol; ‘[—fGf~f...fC[]fVf#f“ fvf[]fgfRf<)  
,É,Ç,ª, ,è,Û,·[]BWindows NT ,É,Í[]A,ç,,Á,©,ì•W[]€ft[]f[]efBfŠfefB,ªŠÛ,Û,è,Ä,ç,Û,·[]B
- CE~S,Áfxfp[]f%ofuf<,É[]Afnf[]fxfvf%ofbfgftfH[]f€,ðftfj[]fg,·,éfnf%ofCfAf“fg  
ft[]fo[] ftfC[]f[]f[]fN,Á,·[]BMicrosoft TCP/IP ,Í[]AWindows Sockets 1.1 fCf“f^[]ftfFfCfX,ðftfj  
[]fg,μ,Û,·[]BWindows Sockets fCf“f^[]ftfFfCfX,Í[]Afnf%ofCfAf“fg ft[]fo[] fAfvfŠfp[]fVf#f“ ,ÍŠ]” ,É—  
[]z“Í,ÉfCf“f^[]ftfFfCfX,Á,·[]B,±,è,É[]€<’ ,·,éfAfvfŠfp[]fVf#f“ ,Í[]Aft[]fh fp[]f[]efB,ì Windows Sockets  
[]€<’ ,lfxf^fbfN,Æ,Æ,à,ÉŽÄ[]s,Á,«,Û,·[]B,³,ç,É[]A,» ,ì,Û,© ,lffbfgf[]fN fvf[]fgfRf<[]A,½,Æ,ì,Í[]AMicrosoft  
NWLink ,É,Ç,à~—p,·,é,±,Æ,ª,Ä,«,Û,·[]BWindows Sockets ,Í[]A'½,,lfpfufŠfbfN fhf[]fCf“ ,ì Internet  
fc[]f<,ÁŽg,ì,è,Ä,ç,Û,·[]B
- Windows NT ,ð[]çŠE<K-Í,ì Internet  
,É[]Ú'±%oÄ“\,É,·,é,½,ß,É•K—v,É<Z[]p,ª'ñ<ÿ,³,è,Û,·[]BTCP/IP[]APPP[]A,“ ,æ,Ñ Windows Sockets ,Í[]AInternet  
ft[]f[]fx,É[]Ú'±,μ,ÄŽg—p,·,é,½,ß,É•K—v,ÉŠì“Ô,ð'ñ<ÿ,μ,Û,·[]B

**Microsoft TCP/IP ,ì\ -v'f**

Microsoft TCP/IP ,É,í\Aflfbfgf\fn fvf\fgfRf<,ìŽÀ'•,É•K—v,È—v'f,ª,·,x,ÄŠÜ,Ü,è,Ä,ç,Ü,·\B,±,è,ç,ì—v'f,É,í\AŽÿ,ì,æ,ª,È,à,ì,ª,è,Ü,·\B

▪ fRfA TCP/IP fvf\fgfRf<\B,±,è,É,í\ATCP (“`—\CEäfvf\fgfRf<)\AIP (fCf“f^[\flfbfg fvf\fgfRf<)\AUDP (ft\fu\ f\ f^fOf%œ fvf\fgfRf<)\AARP (fAfhfCEfX%œ` fvf\fgfRf<)\A,“,æ,ÑICMP (fCf“f^[\flfbfg\CEäfbfZ[\fw fvf\fgfRf<),ªŠÜ,Ü,è,Ü,·\B,±,ìfCf“f^[\flfbfg fvf\fgfRf<CEQ,í\AfRf“fsf... [\f^,ì'É\m•ù-@,Æflfbfgf\fn,ì\U'±•ù-@,ì•W\œ,đ'ñ<ÿ,µ,Ü,·\B,Ü,½\APPP,“,æ,Ñ SLIP (Serial-Line IP; fVfŠfAf<%ñ\ù IP),àfTf\[\fg,ª,è,Ä,ç,Ü,·\B,±,è,ç,ì\AInternet,đŠÜ,p TCP/IP flfbfgf\fn,Ö,ìf\_fCf,,f<fAfbfv\U'±,ÉŽg—p,µ,Ü,·\B

▪ fAfVfŠfP\fvf#f“ fCf“f^[\ftfFfCfX,ìfTf\[\fg\B,±,è,É,í\Aflfbfgf\fn fvf\fgfRf<~f“fO,ì,½,ß,ì Windows Sockets 1.1\AfVfXfef€ŠÖ'É\m,ì,½,ß,ì RPC (fŠf, [\fg fvf\fv\fwff fR\[\f<)\Aflfbfgf\fn\ä,ì~—¼,ÆfZfbfVf#f“,đSm—š,·,é,½,ß,ì NetBIOS\A,“,æ,ÑfhfLf...f\“fg,É-,,ß\ž,Ü,è,½\i•ñ,đflfbfgf\fn,đ'É,¶,Ä<ª—L,·,é,½,ß,ìflfbfgf\fn DDE (“@“ìf\[\f^CEđŠ:),ªŠÜ,Ü,è,Ü,·\B

▪ Šì-{"ì,É TCP/IP \U'±fAfVfŠfP\fvf#f“\B,±,è,É,í\Afinger\Aftp\Alpr\Arcp\Aexec\Arsh\Aatlnet\A,“,æ,Ñ tftp,ªŠÜ,Ü,è,Ü,·\B,±,è,ç,ìft\[\fefBfŠfefB,É,æ,è\AWindows NT,ìft\[\fu\[\ì\AUNIX fRf“fsf...[\f^,É,Ç,ì\AMicrosoft \»•ì,Ä,ì,É,çfzXfg,Æ'ì“b\^—\,µ\A,»,ìfzXfg\ä,ìŽ'CE¹,đŽg—p,Ä,«,Ü,·\B

▪ TCP/IP \f'ffc\[\f<\B,±,è,É,í\Aarp\Ahostname\Aipconfig\Alpq\Anbtstat\Anetstat\Aping\Aroute\A,“,æ,Ñ tracert,ªŠÜ,Ü,è,Ü,·\B,±,è,ç,ìft\[\fefBfŠfefB,ì\ATCP/IP flfbfgf\fn,ì-à'è,ìCEÿ\o,Æ%œ`CE^,ÉŽg—p,Ä,«,Ü,·\B

▪ SeŽifT\[\frX,ÆŠÖ`AŠÇ—\fc\[\f<\B,±,è,É,í\AfŠf, [\fg fRf“fsf...[\f^ŠÖ,Åftf@fCf<,đ“ì—,·,é,½,ß,ì FTP ft\[\fo\[\ ft\[\frX\AfCf“f^[\flfbfgf\fn\ä,ÅfRf“fsf...[\f^¼,đ“@“ì,É“o~^,“,æ,Ñ\Æ%i,·,é,½,ß,ì WINS (Windows fCf“f^[\flfbfg fl\[\f€ ft\[\frX)\AWindows NT fRf“fsf...[\f^ä,Ä TCP/IP,đŽ“@“ì,É\ - ,·,é,½,ß,ì DHCP (“@“ìfzXfg\ -fvf\fgfRf<) ft\[\frX\A,“,æ,Ñ UNIX fRf“fsf...[\f^,É\U'±,ª,è,Ä,ç,èfvfŠf“f^,Ü,½,ì TCP/IP CEo—R,Åflfbfgf\fn,É'¼\U\U'±,ª,è,Ä,ç,èfvfŠf“f^,ÉfAfNfzXfX,·,é,½,ß,ì TCP/IP ^ó\ùft\[\frX,ªŠÜ,Ü,è,Ü,·\B

▪ SNMP (ŠÉ^Öflfbfgf\fnŠÇ—\fvf\fgfRf<) fG\[\fwff“fg\B,±,è,ì\ -v'f,đŽg,ª,Æ\ASun Net Manager,Ü,½,ì HP Open View,É,Ç,ìŠÇ—\fc\[\f<,É,æ,Ä,Ä\AWindows NT fRf“fsf...[\f^,đfŠf, [\fg,ÄŠÇ—\,·,é,±,Æ,ª,Ä,«,Ü,·\B,Ü,½\ASNMP,đŽg,Ä,Ä DHCP ft\[\fo\[\,Æ WINS ft\[\fo\[\,đŠÄŽ<,“,æ,ÑŠÇ—\,·,é,±,Æ,à,Ä,«,Ü,·\B

▪ ŠÉ^Öflfbfgf\fn fvf\fgfRf<,ì,½,ß,ìfNf%œCfAf“fg f\ftfgfEfffA\B,±,è,É,í\ACharacter Generator (•¶Žš\¶\ -)\ADaytime (“úŽž)\ADiscard (“pŠù)\AEcho (fGfR\[\)\A,“,æ,Ñ Quote of the Day (“úŽ\),É,Ç,ªŠÜ,Ü,è,Ü,·\B,±,è,ç,ìfvf\fgfRf<,É,æ,è\AWindows NT fRf“fsf...[\f^,ì\A,±,è,ç,ìfvf\fgfRf<,đfTf\ [\fg,µ,Ä,ç,è,Ü,©,ìfvfXfef€,©,ç,ì—v<\,É%ž,ì,é,±,Æ,ª,Ä,«,Ü,·\B,±,è,ç,ìfvf\fgfRf<,đ'g,ÿ\ž,ß,Æ\A\ systemroot\SYSTEM32\DRIVERS\ETC fffBfCEfNfgfŠ,ÉfTf“fvf< QUOTES ftf@fCf<,à'g,ÿ\ž,Ü,è,Ü,·\B

Žÿ,ì\},ì\AMicrosoft TCP/IP ,ìŠì-{\ -v'f,Æ\AMicrosoft ,à,Ü,©,ìŠj“ŽÖ,ª'ñ<ÿ,µ,Ä,ç,éŠeŽì,ì'Ç %œ\AfVfŠfP\fvf#f““,æ,Ñ\U'±ft\[\fefBfŠfefB,đŽì,µ,Ä,ç,Ü,·\B

**Microsoft TCP/IP: ŠìŠ<Z\p,ÆfT\[\fh fp\[\fefB,É,æ,é•t%œÁ**





- 1042 IP over Token Ring
- 1055 Transmission of IP over Serial Lines (IP-SLIP)
- 1112 Internet Gateway Multicast Protocol (IGMP)
- 1122, 1123 Host Requirements (communications and applications)
- 1134, 1548 Point to Point Protocol (PPP)
- 1144 Compressing TCP/IP Headers for Low-Speed Serial Links
- 1157 Simple Network Management Protocol (SNMP)
- 1179 Line Printer Daemon Protocol
- 1188 IP over FDDI
- 1191 Path MTU Discovery
- 1201 IP over ARCNET
- 1231 IEEE 802.5 Token Ring MIB (MIB-II)
- 1332 PPP Internet Protocol Control Protocol (IPCP)
- 1334 PPP Authentication Protocols
- 1533 DHCP Options and BOOTP Vendor Extensions
- 1534 Interoperation Between DHCP and BOOTP
- 1541 Dynamic Host Configuration Protocol (DHCP)
- 1542 Clarifications and Extensions for the Bootstrap Protocol (BOOTP)
- 1547 Requirements for Point to Point Protocol (PPP)
- 1549 PPP in HDLC Framing
- 1552 PPP Internetwork Packet Exchange Control Protocol (IPXCP)
- 1553 IPX Header Compression
- 1570 Link Control Protocol (LCP) Extensions
- Draft RFCs NetBIOS Frame Control Protocol (NBFCP); PPP over ISDN; PPP over X.25; Compression Control Protocol

,±,lfjofWfjf“,i Windows NT ,i Microsoft TCP/IP ,É,íATCP/IP Ú‘± (fRfNfBfrfB)  
ftBfŠfB,İŠ@‘S,ĚZfbfgANFS (flbfgfN ft@fCf< fVfXfef€) fTf[fA,“,æ,Ñ **routed** ,â  
**telnetd** ,È,Ç,ì TCP/IP fTfo[ fT[fX (ff[f,““),İŠÜ,Ü,è,Ä,ç,Ü,<sup>1</sup>,ñB,±  
,İŽí,lfAvfŠfP[fVfjf“,âftBfŠfB,İ½,,íAfpufŠfbfN fhfCf“,âfT[fh fpB,©,ç“üŽè,·,é,±  
,Æ,<sup>a</sup>,Ä,«,Ü,·B

## TCP/IP flfbfgf [fN,É," , ,é Windows NT ,lfvŠf... [fVf#f“

“]’—fvf [fgfRf<,Æ,μ,Ä TCP/IP ,đŽg—p, ,é,Æ [AWindows NT fRf“fsf... [f^, íA, Ù, ©, lffbfgf [fN f\ ftfgfEfffA,đ’Ç%Á, ,é,±,Æ,È, [AŽí—p, ì^Ù,È,éfvfXfef€ ,Æ’Ê [M, ,é,±,Æ,ª,Ä,«, Ù, · [BMicrosoft TCP/IP , í [AWindows NT , ì,», ì, Ù, ©, ì<@“\,Æ’g,Ý [‡, í,¹,é,±,Æ,É,æ,è [A’½,, lfvf%fbfgftfH [f€ [ă,ÉŽí— p, ì^Ù,È,éfvfXfef€ ,ÆfvftfgfEfffA,ª [— [Y, ,éŠé<Æflfbfgf [fN,É [AfXfP [f%ofuf<,ÈfvŠf... [fVf#f“ ,đ’ñ<Y,μ,Û, · [B

,±,±,Ä, í [AWindows NT ,Æ TCP/IP ,ª [A,Ç, ì,æ,ª,ÉŠé<Æflfbfgf [fN,ÉfvŠf... [fVf#f“ ,đ’ñ<Y,μ,Ä,ç,é,©,É,Ä,ç ,Ä [à-¾,μ,Û, · [B

TCP/IP ,đŽg,Á,ÄfXfP [f%ofuf<,È Windows flfbfgf [fN,đ [v’z, ,é

TCP/IP ,đŽg,Á,Ä Internet ,É [Ú’±, ,é

^ÙŽíf [fbfgf [fN, ì,½,ß,É TCP/IP ,đŽg—p, ,é

fT [fh fp [fefB [»fvftfgfEfffA,Æ,Æ,à,É TCP/IP ,đŽg—p, ,é



## TCP/IP ,đŽg,Á,Ä Internet ,ÉÚ'±,·,é

Microsoft TCP/IP for Windows NT ,É,ÍAftpArshA,,"æ,Ñ telnet ,È,ÇA'½,-  
 ,ì'è"É"l,ÈÚ'±fAfvfŠfP[fVf#f",aŠÜ,Ü,è,Ä,ç,Ü,·B,±,è,ç,ìfAfvfŠfP[fVf#f",íAInternet ã,â^ÜŽifVfXfef€  
 ,Æ,ìŠÖ,ÅAftf@fCf<"l'—AfvfŠf,[]fg fvf[]ZfXŽÀ[]s[]A,,"æ,Ñ'ÉM'[-fGf~f...fÇ[]fVf#f",È,Ç,đTf[]  
 []fg,μ,Ü,·B



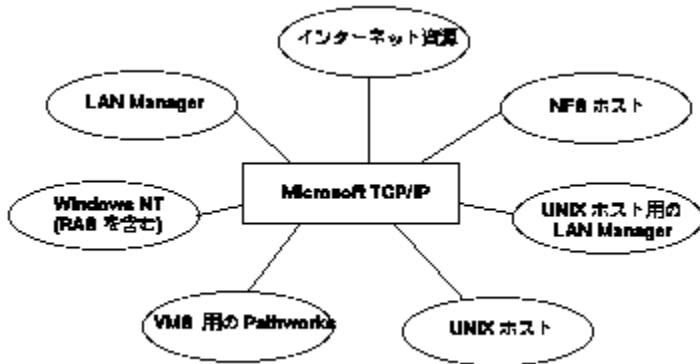

,±,ì,Ü,©,É,àAGopher ,â NCSA Mosaic ,È,ÇÇæçŽÒ,â^è"É,ìft[]fU[][,a[][]-,μ,½A'½,,ì TCP/IP  
 fAfvfŠfP[fVf#f",a ,è,Ü,·B,±,è,ç,íA16 frfbfg,"æ,Ñ 32 frfbfg Windows  
 fx[]fX,ìfAfvfŠfP[fVf#f",Æ,μ,ÄAfpufŠfbfN fhf[]fCf",âft[]fh fp[]fB,©,ç"üŽè,Ä,«,Ü,·B,±  
 ,è,ç,ìfAfvfŠfP[fVf#f",íAWindows Sockets 1.1 <KŠi,É€',μ,Ä,ç,è,ì Windows NT ,ÆÇYŠ·[]«,a ,è,Ü,·B,±  
 ,è,ç,ìfAfvfŠfP[fVf#f",íAŠi-{"l,Èf[]fbfg[]fN[][]-v'f,¾,¯,ÄAfpufŠfbfN fhf[]fCf",ìf...[]fA,Æ Internet  
 Ž'ÇE',ÉfAfNfZfX,·,éAfvfŠfP[fVf#f",đŽg,çAWindows NT frf"fsf...[]f^,đ<-í,È Internet fNf  
 %ofCfAf"fg,Æ,μ,Ä" @[][,³,¹,Ü,·B

LPR ,â Gopher ,È,Ç,ìfpufŠfbfN fhf[]fCf",ì Windows fx[]fX,ìft[]fBfŠfefB,íAInternet ã,â,ì  
 ftp.cica.indiana.edu ,ì /pub/win3/nt fffBfÇfNfgfŠ,Ü,½,í /pub/win3/winsock  
 fffBfÇfNfgfŠ,©Aftp.cdrom.com ,ì"·,ìfffBfÇfNfgfŠ,Ä"üŽè,Ä,«,Ü,·B

## Microsoft TCP/IP fr[]fNfefBfrfefB



Windows NT ,É%Á,ì,ÄA,Ü,Æ,ñ,Ç,ìÇ»'ã"l,Èf[]fyfÇ[]fBf"fo fVfXfef€,a TCP/IP fvf[]fgfRf<,đTf[][]fg,μ,Ä,ç  
 ,é,ì,ÄA^Ü,È,éŽí-p,ìfVfXfef€,a[]-[]Y,·,éCf" f^[]f[]fbfg[]fN,Ä,àAŠÈ'P,Èf[]fbfg[]fN  
 fAfvfŠfP[fVf#f",âft[]fBfŠfefB,đŽg,Á,ÄA[]f·ñ,đ<æ-L,·,é,±,Æ,a,Ä,«,Ü,·BTCP/IP ,đÚ'±fVf[]fgfRf<,ÉŽg  
 -p,·,é,ÆAWindows NT ,ÆŽY,ÉŽ!,·,æ,æ,È'½[]",ì'¼fVfXfef€,Æ,ì'ÉM,a%Á"\\,É,È,è,Ü,·B

-  Internet fzfXfg
-  UNIX fVfXfef€
-  Apple Macintosh fVfXfef€
-  Open VMS fVfXfef€
-  f[]fbfg[]fN,É'¼ÚÚ'±,³,è,½f[]fbfg[]fN fAf\_fvf^,đ"ö,ì,½vfŠf" f^



**ft [fh fp [fefB] » f ftfgfE fFA,Æ,Æ,à,É TCP/IP ,ðŽg—p,·,é**

TCP/IP, í A^ Û Ž í f b f g f [fN,É, ", - ,é < x' Ê Š í" Ö, Å, · B, » , μ, Ä A Windows Sockets , í A f A f v f Š f P [fV f # " Š ]" - Ž Ö, ð Ž g—p, · , é • W € f C f " f ^ [ f t f f C f X, Å, · B, ±, è, ç, ð è ' í, Æ, È, Å, Ä A f N f [f X f v f % o f b f g f t f H [f € f N f % o f C f A f " f g f T [f o [ Š ]" , ì, ½, ß, ì f t f C E [f € f [f N, ð \ [ - , μ, Ü, · B f T [fh fp [fefB, ì f [f [ , ð Š ]" , μ, ½ Windows Sockets , ì < K Š i, É € < ' , · , é TCP/IP f A f v f Š f P [fV f # " , í A C E ' ¥, Æ, μ, Ä A, Ç, ì, æ, x, È Ž À ' • C E ' Ô, ì TCP/IP [ ã, Å, à Ž À [s, Å, «, Ü, · B

Æ » [ Y [ A 30 , ð ' , , é f [f [ , ð Š ]" , μ, ½ Windows f x [f X, ì TCP/IP f t [fefB f Š f e f B, ð A Windows Sockets < K Š i, Æ, ì C E Y Š · [ «, ð Š m " F, ð, è, Å, ç, Ü, · B

, ±, è, É, í A X Window System —p, ì f T [fh fp [fefB] » f A f v f Š f P [fV f # " [ A [ Å V, ì ' [ - - f G f ~ f ... f C E [fV f # " f f t f g f E f f A [ A N F S ( f N f % o f C f A f " f g, ", æ, Ñ f T [f o [ ] [ A " d Ž q f [f < f p f b f P [f W, È, Ç, ð Š Ü, Ü, è, Å, ç, Ü, · B Windows NT , í 16 f r f b f g Windows Sockets , Æ, ì C E Y Š · [ «, ð ' ñ < Ÿ, μ, Å, ç, é, ì, Å A Windows 3.x — p, É [ - [ - , ð, è, ½ A f v f Š f P [fV f # " , í A [ C [ ð, ð A f R f " f p f C f < , ð [s, í, È, , Å, à Windows NT [ ã, Å Ž À [s, · , é, ± , Æ, ð, Å, «, Ü, · B

, ½, Æ, ì, í A X Window —p, ì f T [fh fp [fefB] » f A f v f Š f P [fV f # " , Å, í A X Window f T [f o [ [ A f f [f ^ f x [f X f T [f o [ [ A, ", æ, Ñ ' [ - - f G f ~ f ... f C E [fV f # " , É, æ, Å, Ä A C E ø % o É " í, È [ U ' ± f v f Š f ... [fV f # " , ð ' ñ < Ÿ, μ, Å, ç, Ü, · B, ± , ì, æ, x, È f A f v f Š f P [fV f # " , ð Ž g—p, · , é, Æ [ A ' P ^ è, ì f v f X f e f € [ ð, Å A Windows NT [ A Windows 3.1 [ A, ", æ, Ñ M S - D O S —p, É [ - [ - , ð, è, ½ A f v f Š f P [fV f # " , Æ, ì C E Y Š · [ «, ð • Ü, ÿ, è, ð, ç [ A Windows NT f R f " f s f ... [f ^ , ð X Window f T [f o [ [ f v f % o f b f g f t f H [f € , Æ, μ, Å Ž g—p, · , é, ±, Æ, ð, Å, «, Ü, · B, Ü, ½ [ A, Ü, ©, ì f T [fh fp [fefB] » f f t f g f E f f A, ì ' t, É, í A Windows NT —p, ì X Window f N f % o f C f A f " f g f % o f C f u f % o f Š , È, Ç, ð Š Ü, ñ, ¾, à, ì, ð, , è, Ü, · B, ±, ì, æ, x, È f % o f C f u f % o f Š , ð Ž g, x, ±, Æ, É, æ, è [ A Š ]" Ž Ö, í A X Window f T [f o [ [ f v f X f e f € [ ð, Å f Š f, [f g, È Ž À [s, Æ • \ Ž , ð [s, ì, é [ A X Window f N f % o f C f A f " f g f A f v f Š f P [fV f # " , ð Windows NT [ ã, Å [ - [ - , · , é, ±, Æ, ð, Å, «, Ü, · B





## ŠÖ~Aŋî•ñ,ì“üŽè

Microsoft , ©, ç, ì•W€“l, ÈfTf[]fg, ì, Ù, ©, É[]AInternet , Á, à Windows NT , ìŋî•ñ, ð“üŽè, , é, ±, Æ, ð, Á, «, Ü, ·[]B  
'[] : , ±, ìfT[]fX, ð—~—p, ·, é, É, í[]AfRf“fsf...[]f^, ð Internet , É[]Ú'±, µ, Ä, ç, È, ¯, ê, î, È, è, Ü, ¹, ñ[]B

## Internet , Á Windows NT , ìZpŋî•ñ, ð“üŽè, , é, É, í



**ftp** , ð<N“® , µ[]Amicrosoft.com , É[]Ú'±, µ, Ü, ·[]B

, ±, ìfT[]fX, Á, í[]AWindows NT , ì“½-¼ FTP (anonymous FTP) , ðŽg, Á, Ä[]AŠeŽí, ì US “Á, ì Microsoft  
fVfXfef€[]»•i, ÉŠÖ, , é•ŋ[]Af[]fBfŠfefB[]A, ” , æ, Ñ[]Á[]Vfhf%ofCfo, È, Ç, ìŋî•ñ, ð'ñ<Ÿ, µ, Ä, ç, Ü, ·[]B

TCP/IP , ÉŠÖ, , é, æ, è[]Ú[]x, È<Zpŋî•ñ, É, Á, ç, Ä, í[]AZŸ, ì•ŋ[]CE£, ðŽQ[]Æ, µ, Ä, , ¾, ¾, ç[]B

Allard, J.[]wDHCP--TCP/IP Network Configuration Made Easy[]xConnexions, Volume 7, No. 8[]AAugust 1993.

Allard, J., K. Moore, and D. Treadwell[]wPlug into Serious Network Programming with the Windows Sockets API[]xMicrosoft Systems Journal, July: 35 - 40, 1993.

Comer, D.[]wInternetworking with TCP/IP Volume 1: Principles, Protocols, and Architecture[]xSecond edition. Englewood Cliffs, NJ: Prentice Hall, 1991.

Comer, D. and D. Stevens[]wInternetworking with TCP/IP Volume II: Design, Implementation, and Internals[]xEnglewood Cliffs, NJ: Prentice Hall, 1991.

Comer, D. and D. Stevens[]wInternetworking with TCP/IP Volume III: Client-Server Programming and Applications[]xEnglewood Cliffs, NJ: Prentice Hall, 1991.

Hall, M., et al.[]wWindows Sockets: An Open Interface for Network Programming Under Microsoft Windows[]xVersion 1.1, Revision A, 1993.

Krol, E.[]wThe Whole Internet User's Guide and Catalog[]xO'Reilly and Associates, 1992.

Rose, M.T.[]wThe Simple Book[]xEnglewood Cliffs, NJ: Prentice Hall, 1991.

## TCP/IP ,ì'g,Ýž,Ý,É,Â,ç,Ä

,±,±,Ä,ÍAWindows NT ,ðŽÀs,·,éRf“fsf...[]f^,É TCP/IP ,Æ SNMP fT[]fxfX,ð'g,Ýž,ÝAfvf[]fgfRf<,ð\ []-,·,é•û-@,É,Ä,ç,Äà-¾,μ,Û,·B

TCP/IP fvf[]fgfRf< ftj@f~fŠ,ÍA[],'-fZfbfgfAfbfv,Ä,ÍAWindows NT flfyfCE[]fBf“fo fVfXfef€ ,ì^è•”,Æ,μ,Ä'g,Ýž,Û,è,Û,¹,ñB,±,±,Ä,ÍAWindows NT ,Í,·,Ä,ÉfRf“fsf...[]f^,É[]í,É'g,Ýž,Û,è,Ä,ç ,é,Æ'z'è,μ,Ä,ç,Û,·B

'[] : TCP/IP ,Æ SNMP ,ð'g,Ýž,ñ,Ä[]- ,ðs,κ,É,ÍAAdministrators fOf<[]fv,lf[]f“fo[][,Æ,μ,Äf[]Of[]f“,μ,È,¯,è,Î,È,Û,¹,ñB

ŽÝ,ì[]€-Û,É,Ä,ç,Äà-¾,μ,Û,·B



Microsoft TCP/IP ,ð'g,Ýž,p'O,É



TCP/IP ,ð'g,Ýž,p



TCP/IP ,ð[]- ,·,é



DNS ,ðŽg-p,·,é,½,ß,É TCP/IP ,ð[]- ,·,é



TCP/IP ,ìÚ[]xflfvfVff“,ðÝ'è,·,é



SNMP ,ð[]- ,·,é





## Windows NT TCP/IP 'g,Ýž,ÝfjfvfVfj'

### TCP/IP Internetworking fvfjfgfRf

TCP/IP fvfjfgfRf ATCP/IP ä, NetBIOS ,Æ Windows Sockets fCf^ [ftfFfCfX A, ,æ, Ñ TCP/IP [f^ft [fefBfŠfefB, ð'g, Ýž, Ý, Ü, ·B, ±, ê, ç, Ì—v'f, ÍŽ © " @ " I, É'g, Ýž, Ü, ê, Ü, ·B

### Ú'±ft [fefBfŠfefB

TCP/IP Ú'±ft [fefBfŠfefB, ð'g, Ýž, Ý, Ü, ·B, ±, jfjfvfVfj', ð'í'ð, ·, é, Æ A Ú'± (connectivity) ft [fefBfŠfefB, ð'g, Ýž, Ü, ê, Ü, ·B

### SNMP ft [frfX

SNMP ft [frfX, ð'g, Ýž, Ý, Ü, ·B, ±, jfjfvfVfj', ð'í'ð, ·, é, Æ ASun Net Manager ,â HP Open View ,È, Ç, ÍŠÇ —fc [f, ðŽg, Á, Ä A, ±, jfRf'fsf... [f^, ðfŠf, [fg, ÁŠÇ—, ·, é, ±, Æ, ð, Á, «, Ü, ·B, Ü, ½ A, ±, jfjfvfVfj', ð'í'ð, ·, é, Æ AfpftfH [f} f'fX f, jfj^, ðŽg, Á, Ä ATCP/IP ft [frfX, Ì" CEv ð'ñ, ðŠŽž, ·, é, ±, Æ, à, Á, «, Ü, ·B

### TCP/IP flfbfgf [fN^óüTf [fg

, ±, jfRf'fsf... [f^, í ATCP/IP flfbfgf [fN ä, jfvfŠf'f^, ©, ç'¼ Ú^óü, Á, «, é, æ, x, É, È, è, Ü, ·B, ±, jfjfvfVfj', í A UNIX ^óü'Ö, Ìs—ñ, â Afjfbfgf [fN, É'¼ ÚÚ'±, ð, é, Ä, ç, é TCP/IP fvfŠf'f^, É^óü, µ, ½, ç, ê, ð, É'í'ð, µ, Ü, ·B, Ü, ½ A UNIX fRf'fsf... [f^, ð Windows NT fvfŠf'f^, É— í, Á, «, é, æ, x, È Lpdsrv ft [frfX, ðŽg—p, ·, é, ê, ð, í A, ±, jfjfvfVfj', ð'g, Ýž, Ü, È, ·, é, í, È, è, Ü, ð, ñ B

### FTP ft [fo [ ft [frfX

, ±, jfRf'fsf... [f^, Ì ft [fCf, ð AFTP ,Æ TCP/IP , ðTf [fg, µ, Ä, ç, é, Šf, [fg fRf'fsf... [f^ ("Á, É UNIX ,È, Ç Microsoft , jfjfbfgf [fN »·i, ðŽg—p, µ, Ä, ç, È, ç fRf'fsf... [f^), Æ «—L, Á, «, é, æ, x, É, µ, Ü, ·B, ±, jfjfvfVfj', í ATCP/IP , ðŽg—p, µ, Ä, Ü, ©, jfRf'fsf... [f^, Æ ft [fCf, ð «—L, µ, ½, ç, ê, ð, É'í'ð, µ, Ü, ·B

### ŠÈ^Ö TCP/IP ft [frfX

Echo (fGfR [ ADaytime ("úŽž) AChargen (·ŸžšŸŸ) A, ,æ, Ñ Discard ("pŠü), È, Ç, Ì TCP/IP ft [frfX, Ì, ½, ß, jfNf%oCfAf'fg fvtfgfEfFfA, ð'ñ'ç, µ, Ü, ·B, ±, jfjfvfVfj', ð'í'ð, ·, é, Æ A, ±, é, ç, jfvf [fgfRf, ðTf [fg, µ, Ä, ç, é, Ü, ©, jfvfXfef€, ©, ç, Ì—v'ç, É%ž"š, Á, «, é, æ, x, É, È, è, Ü, ·B

### DHCP ft [fo [ ft [frfX

fCf^ [fjfbfgf [fN ä, Á TCP/IP , ðŽg—p, ·, é, Rf'fsf... [f^, É'í, µ, Ä ATCP/IP , ÍŽ © " @ [ , Æ Ž © " @ fAfhfCfX Ý'è, ðTf [fg, ·, é, ½, ß, jfT [fo [ fvtfgfEfFfA, ð'g, Ýž, Ý, Ü, ·B, ±, jfjfvfVfj', í A, ±, jfRf'fsf... [f^, ð DHCP ft [fo [ , É, È, é, ê, ð, É'í'ð, µ, Ü, ·B, ±, jfjfvfVfj', í A Windows NT Server ,¾, ·, Á— —p, Á, «, Ü, ·B

, ±, jfjfvfVfj', ð'í'ð, µ, ½, ê, ð, í AfRf'fsf... [f^, Ì IP fAfhfCfX AfTfuflfbfg f}fXfN A, ,æ, Ñ ffftfHf'fg fQ [fgfEfFfC, ðŽž © , Á, Ä —, ·, é, ·K—v, ð, , è, Ü, ·B, Ü, ½ A, ±, jfT [frfX, ðŽg, Á, Ä TCP/IP , ÍŽ © " @ [ —, ð, ð, x, fVfXfef€, Ì, ½, ß, Ì —, ð'ñ, àŽw'è, µ, È, ·, é, í, È, è, Ü, ð, ñ B

### WINS ft [fo [ ft [frfX

Windows fCf^ [fjfbfgf [fN ä, jfRf'fsf... [f^, É A WINS , Æ C Ä, Ö " @ " I, È—¼ O%ðCE^ft [frfX, ðTf [fg, ·, é, ½, ß, jfT [fo [ fvtfgfEfFfA, ð'g, Ýž, Ý, Ü, ·B, ±, jfjfvfVfj', í A, ±, jfRf'fsf... [f^, ð fvf%oCf}fŠ (1 ŽÝ), Ü, ½, jfzjff'f'fŠ (2 ŽÝ), Ì WINS ft [fo [ , Æ, µ, Ä'g, Ýž, P, ê, ð, É'í'ð, µ, Ü, ·B, ±, jfRf'fsf... [f^, ð WINS

'ä—□ fG□[fWfFf“fg (proxy agent) ,É,·,é□ê□#,í□A,±,ìfìfvfVf#“ ,í'í'ð,μ,È,ç,Å,,¾,³,ç□B,± ,ìfìfvfVf#“ ,í□AWindows NT Server ,¾,·,Å—~—p,Å,«,Ü,·□B

**DHCP Ž©“®□\□-,ð—LCEø,É,·,é**

,±,ìfRf“fsf...□[f^,ì TCP/IP fpf%of□□[f^,ìŽ©“®□\□-,ð—LCEø,É,μ,Ü,·□B,±,ìfìfvfVf#“ ,í□AŽg— p,·,éfcf“f^□[fìfbfgf□□[fn□ä,É□A“®“ìfzfXfg□\□-,ðfTf|□[fg,·,é DHCP fT□[fo□[,²'¶□Ý,·,é□ê□#,Éfìf“ ,É,μ,Ü,·□B,±,é,í□A'½,,ì□ê□#□AWindows NT fRf“fsf...□[f^,É TCP/IP ,ð□ □-,·,·,é,æ,è-],Ü,μ,ç•û-@,Å,·□B

DHCP fT□[fo□[ fT□[fRfX fìfvfVf#“ ,ð'í'ð,μ,Ä,ç,é□ê□#□A,±,ìfìfvfVf#“ ,í~—p,Å,«,Ü,¹,ñ□B

TCP/IP ,ð'g,Ý□ž,p,Æ□A\systemroot\SYSTEM32\DRIVERS\ETC fffBfçEfNfgfŠ,É□AfffftHfçfg,ì HOSTS□ANETWORKS□APROTOCOLS□AQUOTES□A,“ ,æ,ñ SERVICES ,É,Ç,ìftf@fCfç,²'u,©,ê,Ü,·□B,Ü,½□ALMHOSTS ftf@fCfç,ì'Ž©,ðçL□q,μ,½fTf“fvfç ftf@fCfç LMHOSTS ,à'u,©,ê,Ü,·□B

Microsoft TCP/IP ,ðfRf“fsf...□[f^,É'g,Ý□ž,p□Ü,Éfgf%ofufç,²"□¶,μ,½□ê□#,í□AfGf%□[ f□fbfZ□[fW,ìžwŽ; ,É□] ,Á,Ä,,¾,³,ç□Bping ,É,Ç,ì□f'fft□[fefBfŠfefB,ðžg—p,μ,Ä,à□Afìfbfgf□□[fn fn□[fhfEjffA,ì-â'è,â□ □-,ì"ñçÉÝŠ□«,ì-â'è,ð•²□í,·,é,±,Æ,²,Å,«,Ü,·□B

ŠÖ~A□€-Ú

TCP/IP □f'fft□[fefBfŠfefB,É,æ,éfgf%ofufçfvf...□[fefBf“fo

## TCP/IP ,đ□□□□,.,é

TCP/IP ,đRf“fsf...□□f^,Á“@□,³,¹,é,É,Í□A fRf“fsf...□□f^,É’•’...³,é,Ä,ç,éŠeflfbfjgf□□□fN fAf\_fvf^,É’í,μ,Ä□AIP fAfhf(efX□A fTfuflfbfg f}fXfN□A,“,æ,Ń ffftfHf<fg fQ□□fgfEfFfC,đ□□□□,μ,È,¯,ê,Î,È,è,Û,¹,ň□B Microsoft TCP/IP ,ì□□□□,í□AŽŸ,ì 2 ,Á,ì^Ù,È,é•û-@,Á□s,κ,±,Æ,ª,Á,«,«,Û,·□B



### DHCP ,đŽg,κ

fCf“f^□□□fLfbfjgf□□□fN□ā,É DHCP fT□□fo□□[.ª, ,é□é□±,Í□A,±,ìfT□□fo□□[.ª DHCP (“@“lfzfXfg□□□□-fvf□fgfRf<), đŽg,Á,Ä□A fRf“fsf...□□f^,É TCP/IP ,đŽ©“@“I,É□□□□□,μ,Û,·□B



### TCP/IP ,ì□□□□,đŽè“@,Á□s,κ

DHCP fT□□fo□□[.ª“¶□Ÿ,μ,È,ç□é□±□A, ,é,ç,í□A,» ,ì Windows NT Server fRf“fsf...□□f^,đ DHCP fT□□fo□□[.É,·,é□é□±,Í□A TCP/IP ,ì□□□□□,í,·,×,ÄŽè“@,Á□s,í,È,¯,ê,Î,È,è,Û,¹,ň□B

## DHCP ,đŽg,±

TCP/IP ,đŠÈ'P,©,Á³Šm,É'g,Ýž,þÁ,à,æ,ç•û-@,íADHCP ,É,æ,éŽ©“®\¬,đŽg,±,Æ,Á,·BDHCP Ž©“®\¬,Á,íADHCP ,đŽg,Á,Äf“fj“fRf“fsf...[f^,ÉA³,µ,ç IP fAfhfCEfXAfTfufjfbfg f}fXfN[A,“,æ,ÑfftfHf<fg fQ[fgfEfffC,đÝ'è,µ,Û,·B

DHCP fT[fö[ ,afjfbfgfö[fN,É'g,Ýž,Û,è,Ä,ç,è,íATCP/IP ,ì\¬,í,±,ì•û-@,É,æ,èŠÈ'P,És,±,Æ,²,Á,«,Û,·B,±,ì•û-@,đ~—p,Á,«,é,©,Ç,±,©,íAfjfbfgfö[fNŠÇ—ŽÒ,ÉŠm”F,µ,Ä,,¼,³,çB

' : DHCP fT[fö[ ,Û,½,í WINS fT[fö[ ,É,·,é,½,ß,É TCP/IP ,ì'g,Ýž,Ý,đs,Á,Ä,ç,éfT[fö[ ,Á,íADHCP ,É,æ,éŽ©“®\¬,í~—p,Á,«,Û,¹,ñB,Á,Û,èADHCP fT[fö[ ,É'í,µ,Ä,íATCP/IP ,ìÝ'è,đŽè“®,Ás,Á,Ä\¬,µ,Û,·B

## DHCP ,đŽg,Á,Ä TCP/IP ,đ\¬,·,é,É,í

1. [Windows NT TCP/IP 'g,Ýž,Ýfjvfj“] f\_fCfAfö f{fbfNfX,Û,½,í [TCP/IP ,ì\¬] f\_fCfAfö f{fbfNfX,ÁADHCP Ž©“®\¬,đ—LCEø,É,·,é] f`ffbfN f{fbfNfX,đlf“ ,É,µ,Ä,ç,é,± ,Æ,đŠm”F,µ,Û,·B

2. TCP/IP ,ì'g,Ýž,Ý,đŠ®—¹,µ,½æä,ÄfRf“fsf...[f^,đÄ<N“®,·,é,ÆADHCP fT[fö[ ,“KØ,È\ ¬-î•ñ,đŽ©“®“l,ÉfRf“fsf...[f^,É'ñ<Ý,µ,Û,·B

,±,ìæä[fjfbfgfö[fN,ìÝ'è] f\_fCfAfö f{fbfNfX,Á TCP/IP ,ì\¬,đs,“,± ,Æ,·,é,ÆAZè“®Ý'è,đs,Á,½èè#ADHCP ,©,ç'ñ<Ý,³,è,½Ž©“®Ý'è,ì“à—e,²•í,í,Á,Ä,µ,ç,Û,·BDHCP ,©,ç'ñ<Ý,³,è,½Ý'è,đ“Á,É•É,ì,à,ì,É,µ,½,çèè# ,đœ,ç,ÄA^è”É,ÉAZ©“®Ý'è,³,è,½“à— e,í•íX,·,x,«,Á,í, ,è,Û,¹,ñB

ŠÖ~A€-Ú

TCP/IP ,ì\¬,đŽè“®,Ás,±

DHCP fT[fö[ ,ì'g,Ýž,Ý,Æ\¬



## TCP/IP ,ì\ñ- ,ðžè“® ,Á\š,ž

DHCP fT\fo\ ,Ü,½,í WINS fT\fo\ ,É TCP/IP ,ð'g,Ýžž,Pèèž,âADHCP ,É,æ,éžž“®\ñ- ,ð-~— p,Á,«,É,çèèž,ìA Microsoft TCP/IP fv\fgfRf< f\ftfgfEfffA,ð'g,Ýžž,ñ,¼æä,ÁA— LCEø,ÉfAfhfCEfX\î•ñ,ðžè“® ,Ážw'è, ,é•K—v, ,è,Ü,·B

WINS fT\fo\ ,Á, ,éfRf“fsf...[f^ ,É•;“],lflfbfgf\fn fAf\_fvf^ f\fh, ,éèèžA WINS ,í TCP/IP ,ÉCE<žž, ,é,Á,ç,éfAf\_fvf^ ,ì^è—“à,ìA\%0,ì,à,ì,ÉCE<žž,μ,Ü,·B,±,lfAf\_fvf^ ,lfAfhfCEfX, ,é 0 ,ÉÝ'è, ,é,Á, ,ç, ,A,Ü,½ IP fAfhfCEfX,ìCE<žž, ,é•K\ø,Á, ,é,±,Æ,ðSm“F,μ,Á, ,¼, ,ç,çB

TCP/IP ,ì\ñ- ,ðš,ž,É,íA,»,ìf\ffj< fRf“fsf...[f^ ,ì Administrators fOf<[fv,lf\ff“fo\ ,Æ,μ,Áf\ffOfj“ , ,é•K—v, ,è,Ü,·B

CEx : fAfhfCEfX,ìd•; ,ðž, ,é,½,ž,ÉAIP fAfhfCEfX, ,æ,ÑfTfuf\fbfg f}fXfN,ìAflfbfgf\fnŠÇ— ŽÖ, ©, ç'ñ<Ý, ,é,½'ì,ðžg—p,μ,Á, ,¼, ,ç,çBfAfhfCEfX, ,é d•; ,μ,Á,ç,é,ÆAflfbfgf\fnŠ,ìfRf“fsf... [f^ ,É—\ ,é,Á,«,É,ç%e<žž,ð—^ ,ì,é,±,Æ, ,è,Ü,·B\Úx ,É,Á,ç,Á,ìAIP fAfhfCEfXžw'è,ðžQ\Æ,μ,Á, ,¼, ,ç,çB

## TCP/IP fv\fgfRf< ,ðžè“® ,Á\ñ- , ,é,É,í

1. TCP/IP ,ì'g,Ýžž,Ýt,ìèèž,ìA[Windows NT TCP/IP 'g,Ýžž,Ýf\fvfVfj“] f\_fCfAf\fo f{fbfNfX,Á [ '±\š] f{f^f“ ,ðfNfŠfbfN, ,é,ÆA[Microsoft TCP/IP ,ì\ñ-] f\_fCfAf\fo f{fbfNfX, ,é±, ,Á•Žì, ,é,Ü,·B

TCP/IP ,ðžèèž,ìA fRf“fgf\ffj< f\fh,ì [lflfbfgf\fn] ,ð'N“® ,μ,Ü,·B[lflfbfgf\fn,ìÝ'è] f\_fCfAf\fo f{fbfNfX, ,é•Žì, ,é,Ü,·B[ 'g,Ýžž,Ü,é,Á,ç,éflfbfgf\fn f\ftfgfEfffA] ^è— ,ÁATCP fv\fgfRf< ,ð'ì'ð,μA[ñ-] f{f^f“ ,ðfNfŠfbfN,μ,Ü,·B[TCP/IP ,ì\ñ-] f\_fCfAf\fo f{fbfNfX, ,é•Žì, ,é,Ü,·B

2. [fAf\_fvf^ f\fh] ^è— ,ÁAIP fAfhfCEfX,ðžÝ'è, ,éflfbfgf\fn fAf\_fvf^ ,ð'ì'ð,μ,Ü,·B

[fAf\_fvf^ f\fh] ^è— ,É,ìA fRf“fsf...[f^ ã,ìAIP , ,éCE<žž, ,é,Á,ç,éflfbfgf\fn fAf\_fvf^ , ,é, ,x,Á•Žì, ,é,Ü,·B\%0,ž,Á,ìèèž,ìA,±,ì^è— ,É,ìA fRf“fsf...[f^ ,É'g,Ýžž,ñ,Á, ,éAf\_fvf^ , ,é, ,x,Á•Žì, ,é,Ü,·B

IP ,ðCE<žž, ,éŠéfAf\_fvf^ ,ÉAflfbfgf\fnŠÇ— ŽÖ, ©, ç—^ ,ì,ç,é,½CEÁ—L,ì IP fAfhfCEfX\î•ñ,ðž,μ,ç'ì,ÁÝ'è, ,é•K—v, ,è,Ü,·Bflfbfgf\fn fAf\_fvf^ ,É'ì, ,éCE<žž,ìAflfbfgf\fn fv\fgfRf< ,éflfbfgf\fn f\ftfgfEfffA,ì,Ü, ©,ì'w,Æ,ç,ì,æ,ž,É<—ì,μ,Á“ , ,©,ð'è,ž,Ü,·B

3. CE<žž,ðš,ž,»,é,¼,é,lf\fbfgf\fn fAf\_fvf^ ,É'ì,μ,ÁAIP fAfhfCEfX,ÆfTfuf\fbfg f}fXfN,ðžw'è,μ,Ü,·B



[IP fAfhfCEfX] f{fbfNfX,ì'ì,ìA,»,ìf\ffj< fRf“fsf...[f^ ,ì IP fAfhfCEfX,ð•,μ,Ü,·B•;“],lflfbfgf\fn f\fh,ð'g,Ýžž,ñ,Á,ç,éèèž,ìA[fAf\_fvf^ f\fh] f{fbfNfX,Á'ì'ð,μ,½fAf\_fvf^ f\fh,É'ì, ,é IP fAfhfCEfX,Á,·B



[fTfuf\fbfg f}fXfN] f{fbfNfX,ì'ì,ìA'ì'ð,μ,½flfbfgf\fn fAf\_fvf^ ,lflfbfgf\fn f\ff“fo\fvfbfv,Æ,»,lfzfXfg ID ,ð•,μ,Ü,·BfvfXfefE,ìA,±,ì'ì,ðžg,Á,Á IP fAfhfCEfX,ðfzfXfg,Æf\fbfgf\fn ID ,É•—É, ,é,±,Æ, ,é,«,Ü,·B

qd—v : [DHCP Žž“®\ñ- ,ð—LCEø,É, ,é] f'fFfbfN f{fbfNfX,ðfj“ ,É,μ,Á,ç,éèèžA,±,lf\_fCfAf\fo f{fbfNfX,Ážè“® ,Á“ü—ì,μ,½'ì,ì, ,x,ÁADHCP ,É,æ,éžž“®“ì,ÉÝ'è, ,é,½'ì,ðžž, «,μ,Ü,·B,± ,lf\_fCfAf\fo f{fbfNfX,ì DHCP Žž“®\ñ- ,lf'fFfbfN f{fbfNfX,ðfj“ ,É, ,é,ÆA'ì,ð“ü—ì, ,é•K—v, ,é,É, ,è,èA,Ü,½fAfhfCEfX,âf}fXfN'ì,ð“ü—ì, ,é,±,Æ, ,é,«,É, ,è,è,Ü,·B

4. Šéf\fbfgf\fn fAf\_fvf^ ,É'ì,μ,ÁA[ffftfHf<fg fQ\fgfEfffC] f{fbfNfX,ÉAflfbfgf\fnŠÇ— ŽÖ, ©, ç—^ ,ì,ç,é,½žž,μ,ç IP fAfhfCEfX'ì,ð“ü—ì,μ,Ü,·B



**DNS ,đŽg—p,·,é,½,β,É TCP/IP ,đ□□—,·,é**

TCP/IP ,í□AIP fAfhfCEfX,đŽg,Á,ÄfRf“fsf...□[f^,đŽ~·É,μ□A-U“l,lfRf“fsf...  
□[f^,É“ž‘B,μ,Ü,·,ª□A^è”É,É□Aft□[fU□[É,Æ,Á,Ä,lfRf“fsf...□[f^-¼,đŽg,μ,Ü,ª,ª•Ö—~ ,Á,·□BDNS (Domain  
Name System; fhf□fCf“ f□□f€ fVfXfef€) ,í□AUNIX flfbfgf□□[fN,í□cŠE,Á^è”É“l,ÉŽg,í,é,Ä,ç,é-  
¼‘O•t, fT□[fRfX,Á, ,è□AIP fRf“fsf...□[f^,É•W□€,-¼‘O•t,~<K‘¥,đ‘ñ<Ÿ,μ,Ü,·□Bftp ,â telnet ,É,Ç,ì  
Windows Sockets fAfvfŠfP□[fVfj“ ,â TCP/IP  
ft□[fefBfŠfefB,Á,í□AŠO•“fzfXfg,âflfbfgf□□[fNä,ì^ÜžifVfXfef€,É□Ú‘±,·,é,Æ,«□AHOSTS ftf@fCf<,É%oÁ,ì,Ä  
DNS ,đŽg,Á,ÄfVfXfef€,đCE©,Á,~ ,é,±,Æ,ª,Á,« ,Ü,·□B

DNS ,đŽg—p,·,é,æ,μ,ÉfRf“fsf...□[f^,đ□□—,·,é•K—v,ª, ,é,©,Ç,μ,©,í□Aflfbfgf□□[fNŠÇ—□ŽÒ,É-  
â,ç□ž,í,¹,Ä,,¾,¾,ç□B‘É□□ATCP/IP ,đŽg—p,μ,Ä Internet ,Á‘É□M,·,é□é□ž,â□AfCf“f^□[flfbfgf□□[fN,ª DNS  
,đŽg—p,μ,ÄfzfXfg□í‘ñ,đ“z•z,μ,Ä,ç,é□é□ž,í□ADNS ,đŽg—p,μ,Ü,·□B□Ú□×,É,Á,ç,Ä,í□Afhf□fCf“ f□□f€  
fVfXfef€,lfAfhfCEfXŽw`è,đŽQ□Æ,μ,Ä,,¾,¾,ç□B

Microsoft TCP/IP ,í□AInternet -¼,Ü,½,í UNIX fVfXfef€-¼,đ%ođCE^ ,·,é,½,β,ì DNS fnf%ofCfAf“fg fl  
ftfgfEfffA,đ‘ñ<Ÿ,μ,Ü,·□B,Ü,½□AMicrosoft Windows flfbfgf□□[fN,Á,í□AWINS ft□[fo□[Æ TCP/IP □ā,ì  
NetBIOS ,É,æ,è□ANetBIOS fRf“fsf...□[f^-¼,É‘í,μ,Ä“@“l,É-¼‘O,ì%ođCE^ ,đ‘ñ<Ÿ,μ,Ü,·□B

DNS ,đŽg—p,·,é,æ,μ,É‘l‘đ,μ,½□é□ž□AfRf“fsf...□[f^,ª,Ç,ì,æ,μ,É DNS ,Æ HOSTS ftf@fCf<,đŽg—  
p,·,é,ì,©,đ□□—,μ,È,~ ,é,ì,È,è,Ü,¹,ñ□BTCP/IP ,í□ADNS □Ú‘±flfVfVfj“ ,đfZfbfgfAfbfv,·,é‘O,É‘g,Ÿ□ž,Ü,è,Ä,ç  
,È,~ ,é,ì,È,è,Ü,¹,ñ□BDNS ,í□A,» ,lfRf“fsf...□[f^,É‘g,Ÿ□ž,Ü,è,Ä,ç,é,·,×,Ä,lffbfgf□□[fN  
fAf\_fvf^,É‘í,μ,ÄfOf□□[fof<,É□□—,³,è,Ü,·□B

‘□ : DNS fhf□fCf“ ,í□AWindows NT ,â LAN Manager ,lfhf□fCf“ ,Æ“~ ,¶,Á,ì ,è,Ü,¹,ñ□B

**TCP/IP DNS fRflfNfefBfRfefB,đ□□—,Ü,½,í□Ä□□—,·,é,É,í**

1. fRf“fgf□□[f< fpflf<,Á [flfbfgf□□[fN] ft□[fefBfŠfefB,đ<N“@ ,μ,Ü,·□B[flfbfgf□□[fN,ì□Ý‘è] f\_fCfAf□fo  
f{fbfNfX,ª•\Žì,³,è,Ü,·□B[‘g,Ÿ□ž,Ü,è,Ä,ç,éflfbfgf□□[fN flftfgfEfffA] ^è— ,Á□ATCP/IP  
fVf□fgfRf<,đ‘l‘đ,μ□A[□□—] f{f^f“ ,đfNfŠfbfN,μ,Ü,·□B[TCP/IP ,ì□□—] f\_fCfAf□fo f{fbfNfX,ª•\  
Žì,³,è,Ü,·□B

2. [DNS] f{f^f“ ,đfNfŠfbfN,μ,Ü,·□B[DNS ,ì□□—] f\_fCfAf□fo f{fbfNfX,ª•\Žì,³,è,Ü,·□B

3. •K—v,É%ož,¶,Ä [fzfXfg-¼] f{fbfNfX,ÉfzfXfg-¼ (‘É□,í□Aft□[fU□[lfRf“fsf...□[f^-¼) ,đ“ü—í,μ,Ü,·□B  
fzfXfg-¼,É,í□AA □` Z ,ìŠe•¶Žš□A0 □` 9 ,ìŠe□“Žš□A,“ ,æ,ŃfnfCftf“ (-) ,đŽg—  
p,Á,« ,Ü,·□BffftfHf<fg,Á,í□A,±,ì‘l,í Windows NT fRf“fsf...□[f^-¼,Á,·,ª□Aflfbfgf□□[fNŠÇ—  
□ŽÒ,í□AfRf“fsf...□[f^-¼,đ•ì□X,¹, ,ÉfzfXfg-¼,É•É,ì-¼‘O,đŠ,,è“- ,Ä,é,±,Æ,ª,Á,« ,Ü,·□B

‘□ : Windows NT fRf“fsf...□[f^-¼,ÉŽg—p,Á,« ,é•¶Žš,ì‘t,É,í□AfzfXfg-¼,É,ìŽg—p,Á,« ,È,ç  
,à,ì,à ,è,Ü,·□B“Á,É□AfAf“f\_fXfRfA ( ) ,í□AfzfXfg-¼,É,ìŽg—p,Á,« ,Ü,¹,ñ□B

fzfXfg-¼,í□A,ç,·,Ä,©,lf□[fefBfŠfefB,Á□A“F□ØŽž,Éf□□[fj< fRf“fsf...□[f^,đ-¼‘O,ÁŽ~·É,·,é,½,β,ÉŽg  
—p,³,è,Ü,·□B,» ,ì,Ü,©□Arexec ,È,Ç,ì,æ,μ,É TCP/IP fx□[fX,lf□[fefBfŠfefB,í□A,±,ì‘l,đŽg—  
p,μ,Äf□□[fj< fRf“fsf...□[f^-¼,đŽæ“¾,μ,Ü,·□BfzfXfg-¼,í□ADNS ft□[fo□[“à,lfzfXfg-¼,đ IP  
fAfhfCEfX,ÉŠ,,è“- ,Ä,éfe□[fuf<,ÉŠì“[ ,³,è,Ü,·□B

4. •K—v,É%ož,¶,Ä [fhf□fCf“-¼] f{fbfNfX,É□Afhf□fCf“-¼,đ“ü—í,μ,Ü,·□B‘É□□Afhf□fCf“-¼,í□A‘g□□D-  
¼,ìEä,ÉfsfŠflfh,Æ‘g□□D,ìží—p,đ•,·Šg‘£Žq,đ•t,~ ,Á•\<L,μ,Ü,· (microsoft.com ,È,Ç)□B  
fhf□fCf“-¼,É,í□AA □` Z ,ìŠe•¶Žš□A0 □` 9 ,ìŠe□“Žš□A,“ ,æ,ŃfnfCftf“ (-) ,đŽg—  
p,Á,« ,Ü,·□B,Ü,½□Aæ□□,è•¶Žš,Æ,μ,ÄfsfŠflfh (.) ,đŽg—p,Á,« ,Ü,·□B

fzfXfg-¼,Æ,±,lfhf□fCf"-¼,ª,ç,Á,µ,â,É,È,è□A,» ,lfRf"fsf...□lf^,ì FQDN (Fully Qualified Domain Name; Š®'S□□üfhf□fCf"-¼) ,ð□□¬,µ,Ü,·□BFQDN ,í□AfzfXfg-¼,ìCEä,ÉfsfŠfJfh,Æfhf□fCf"-¼,ð•t,¬,Ä•\<L,µ,Ü,·□B,½,Æ,í,í□Acorp01.trey.com ,ì,æ,æ,É•\<L,³,è,Ü,·□B,±,ì□è□#□Acorp01 ,ªfzfXfg-¼□Atrey.com ,ªfhf□fCf"-¼,Ä,·□BDNS □Æ%öï,ìŠÖ,í□A'Z,çfhf□fCf"-¼,Éf□□fjfk< fhf□fCf"-¼,ª•t%öÁ,³,è,Ü,·□B

5. [fhf□fCf" f□□f€ fT□lfRfX (DNS) fT□[fo□,ìCEÿ□ð□#□~] f{fbfNfX,É□A-¼'O%öðCE^,ð'ñ<ÿ,·,é DNS fT□[fo□,ì,ì IP fAfhfCEfX,ð"ü—í,µ,Ü,·□BŽÿ,É□A[ 'Ç%öÁ] f{f^f" ,ðfNfŠfbfN,µ,Ä□AIP fAfhfCEfX,ð%öE'æ ,ì^è—,É^Ú"® ,µ,Ü,·□BfJfbfgf□□fNŠÇ—□ŽÒ,í□A,±,lfpf%öf□□lf^ ,É□³,µ,ç'ì,ªŽw'è,³,è,é,æ,æ,É,µ,Ä,-,¾,³,ç□B

DNS fT□[fo□,ì IP fAfhfCEfX,í□A3 ,Ä,Ü,Ä'Ç%öÁ,Ä,« ,Ü,·□BDNS ,ðŽÀ□s,µ,Ä,ç,é fT□[fo□,ì□A^è—,É•\ Ž,³,è,Ä,ç,é□#□~ ,Ä□Æ%öï,³,è,Ü,·□BIP fAfhfCEfX,ì•\Ž!□#□~ ,ð•ì□X,·,é,É,í□A•ì□X,·,é IP fAfhfCEfX,ð'ì'ð,µ□A□äCEü,«-î^óf{f^f" ,Æ%öCEü,«-î^óf{f^f" ,ðŽg,Ä,Ä^Ú"® ,³,¹,Ü,·□BIP fAfhfCEfX,ðŽæ,è□œ,·,É,í□AIP fAfhfCEfX,ð'ì'ð,µ□A[í□œ] f{f^f" ,ðfNfŠfbfN,µ,Ü,·□B

6. [fhf□fCf" fTftfBfbfNfX,ìCEÿ□ð□#□~] f{fbfNfX,É□Afhf□fCf" fTftfBfbfNfXCEÿ□ð^è—,É'Ç %öÁ,·,éfhf□fCf" ,lfTftfBfbfNfX (□Ú"öŽ«) ,ð"ü—í,µ□A[ 'Ç%öÁ] f{f^f" ,ðfNfŠfbfN,µ,Ü,·□B ,±,ì^è—,É,í□A-¼'O%öðCE^Žž,ÉfzfXfg-¼,É•t%öÁ,³,è,é DNS fhf□fCf" fTftfBfbfNfX,ðŽw'è,µ,Ü,·□Bfhf□fCf" fTftfBfbfNfX,í 6 ,Ä,Ü,Ä'Ç%öÁ,Ä,« ,Ü,·□Bfhf□fCf" fTftfBfbfNfX,ìCEÿ□ð□#□~ ,ð•ì□X,·,é,É,í□A•ì□X,·,é fTftfBfbfNfX,ð'ì'ð,µ□A□äCEü,«-î^óf{f^f" ,Æ %öCEü,«-î^óf{f^f" ,ðŽg,Ä,Ä^Ú"® ,³,¹,Ü,·□Bfhf□fCf" fTftfBfbfNfX,ðŽæ,è□œ,- ,É,í□AŽæ,è□œ,« ,½,çfhf□fCf" fTftfBfbfNfX,ð'ì'ð,µ□A[í□œ] f{f^f" ,ðfNfŠfbfN,µ,Ü,·□B

7. DNS fJfvfVfJf" ,ì□Ý'è,ðŠ®—¹,µ,½,ç□A[OK] f{f^f" ,ðfNfŠfbfN,µ,Ü,·□B

8. [TCP/IP ,ì□Ý'è] f\_fCfAf□fO f{fbfNfX,ª□Ä•\Ž!,³,è,½,ç□A[OK] f{f^f" ,ðfNfŠfbfN,µ,Ü,·□B[fJfbfgf□□fN,ì□Ý'è] f\_fCfAf□fO f{fbfNfX,ª□Ä"x•\Ž!,³,è,½,ç□A[OK] f{f^f" ,ðfNfŠfbfN,µ,Ü,·□B

□Ý'è,ð—LCEø,É,·,é,É,í□Afrf"fsf...□lf^ ,ð□Ä•N"® ,µ,È,¬,è,î,È,è,Ü,¹,ñ□B



LMHOSTS ftf@fCf<,đŽg—p,μ,Ü,·□B

8. fCf“f^□[flfbfgf□□[fN,ª TCP/IP □ā,ì NetBIOS ,đŽg,ç□A“ÆŽ©,lfXfR□[fvŽ~•ÊŽq,đŽ□,Á,Ä,ç ,é□ê□#□A[fxfR□[fv ID] f{fbfNfX,É,±,ì‘I,đ“ü—í,μ,Ü,·□B
- TCP/IP fCf“f^□[flfbfgf□□[fN□ā,ìRf“fsf...□[f^ŠÔ,Ā‘Ê□M,·,é,É,í□ATCP/IP
- fCf“f^□[flfbfgf□□[fN□ā,ì,·,x,Ā,ìRf“fsf...□[f^,ª“~,¶lfXfR□[fv ID ,đŽ□,½,Ê,~ ,é,î,Ê,è,Ü,¹,ñ□B‘Ê□í□A,± ,ì‘I,í<ó““),Ü,Ü,É,μ,Ā,“,<,Ü,·□BfxfR□[fv ID ,í□Afof<□[fv“à,ĀÆÝ,ç,É‘Ê□M,μ□#,ç□A,Ü,©,lfVfXfef€ ,Æ,í‘Ê□M,μ,È,çRf“fsf...□[f^,¾,~ ,ìfof<□[fv,ÊŠ,,è“—,Ā,ç,è,Ü,·□B,±,é,ç,lfRf“fsf...□[f^,í□AfxfR□[fv ID ,ª“~^ê,É,ç,í□A,“ÆÝ,ç,đCE©,Ā,~ ,é,±,Æ,ª,Ā,<,Ü,·□BfxfR□[fv ID ,í□ATCP/IP □ā,ì NetBIOS ,ÉŠí,Ā,- ‘Ê□M,¾,~ ,ĀŽg—p,³,è,Ü,·□B
- flfbfgf□□[fNŠÇ—□ŽÒ,í□A•K—v,È□ê□#,É,í□A,±,±,É□³,μ,ç‘I,ªŽw‘è,³,è,é,æ,π,É,μ,Ā,,¾,³,ç□B
9. □Ā‘I IP f<□[fefBf“fo,đflf“ ,É,·,é,É,í□AIP f<□[fefBf“fo,đ—LCEø,É,·,é] f`fFbfN f{fbfNfX,đflf“ ,É,μ,Ü,·□B ,±,ìf`fFbfN f{fbfNfX,đflf“ ,É,·,é,Æ□A,±,ìRf“fsf... □[f^,í□Aflfbfgf□□[fN□ā,ì,Ü,©,ì□Ā“lf<□[f^□[ ,đŽg,Ā,Āflfbfgf□□[fN,ÉŽQ%Ā,,é,± ,Æ,ª,Ā,<,·,Ü,·□Bflfbfgf□□[fN f□[fh,đ•;□“Ž□,¿□Aft□[fU□[ ,ìflfbfgf□□[fN,ª□Ā“lf<□[f^□[ ,đŽg—p,μ,Ā,ç ,é□ê□#,í□A,±,ìf`fFbfN f{fbfNfX,đflf“ ,É,μ,Ā,,¾,³,ç□B,Ü,½□A,>,ì□ê□#,í□A□Ā“lf<□[fefBf“fo fe□[fuf<,à‘Ç%Ā,μ,Ā,,¾,³,ç□B□Ā“lf<□[fefBf“fo fe□[fuf<,ì□[□—,É,Ā,ç,Ā,í□Aroute frf}f“fh,đŽQ□Æ,μ,Ā,,¾,³,ç□B
- fRf“fsf...□[f^,É 1 ,Ā,ìflfbfgf□□[fN fAf\_vf^ ,Æ 1 ,Ā,ì IP fAfhfÆfX,μ,©,È,ç□ê□#,í□A,±,ìflfvfVf#f“ ,í—~ —p,Ā,<,Ü,¹,ñ□B,Ü,½□A,±,ìflfvfVf#f“ ,í□ARIP (Routing Information Protocol; f<□[fefBf“fo□[ñfv□[fgfRf<), đŽĀ□s,μ,Ā,ç,éf<□[f^□[.ÍfTf□[fg,μ,Ü,¹,ñ□B
10. ,±,ìRf“fsf...□[f^,đ□AWINS ff□[f^fx□[fX,ÉŠí,Ā,-¼‘O%đCE^ ,ì,½,ß,ÉŽg—p,·,é□ê□#,í□A[WINS ‘ă— □fG□[fWfFf“fg,đ—LCEø,É,·,é] f`fFbfN f{fbfNfX,đflf“ ,É,μ,Ü,·□B
- ,±,ìf`fFbfN f{fbfNfX,đflf“ ,É,·,é,Æ□Afuf□□[fhfLfffXfg,É,æ,é-¼‘O%đCE^—p,É□[□—,μ,Ā,ç ,é,Ü,©,ìRf“fsf...□[f^,à□A,±,ìRf“fsf...□[f^,đŽg,Ā,Ā WINS fT□[fo□[ ,ª‘ñ<Ÿ,·,é-¼‘O%đCE^fT□[frfX,đ —~—p,·,é,±,Æ,ª%Ā“\,É,Ê,è,Ü,·□B
- ,±,ìflfvfVf#f“ ,í□A[TCP/IP ,ì□[□—] f\_fCfAf□fo f{fbfNfX,Ā□AWIN fT□[fo□[ ,ì IP fAfhfÆfX,đŽw‘è,·,é□ê□#,É,¾,~ —~—p,Ā,<,Ü,· (TCP/IP,đ□[□—,·,é,đŽQ□Æ)□B‘ă— □fG□[fWfFf“fg,í□AWINS fT□[fo□[ ,Ā ,éfRf“fsf...□[f^,Ā,ÍŽĀ□s,Ā,<,Ü,¹,ñ□B
- ,>,ìRf“fsf...□[f^,đ WINS ‘ă—□fG□[fWfFf“fg,Æ,μ,Ā□[□—,·,é•K—v,ª ,é,©,Ç,π,©,ìflfbfgf□□[fNŠÇ— □ŽÒ,É-â,ç□#,í,¹,Ā,,¾,³,ç□BŠefTfufifbfgf□□[fN□ā,Ā WINS ‘ă—□fG□[fWfFf“fg,É,·,x,<Rf“fsf... □[f^,í□A,²,□□“,Ā,·□B
11. □Ú□x,ÈflfvfVf#f“ ,ì□Ÿ‘è,đ□[ ,ì,½,ç□A[OK] f{f^f“ ,đfNfŠfbfN,μ,Ü,·□B[TCP/IP ,ì□[□—] f\_fCfAf□fo f{fbfNfX,ª□Ā“x•\Ž!,³,è,½,ç□A[OK] f{f^f“ ,đfNfŠfbfN,μ,Ü,·□B[flfbfgf□□[fN,ì□Ÿ‘è] f\_fCfAf□fo f{fbfNfX,ª□Ā“x•\Ž!,³,è,½,ç□A[OK] f{f^f“ ,đfNfŠfbfN,μ,Ā□ATCP/IP ,ì□Ú□x,É□[□—,đŠ®—¹,μ,Ü,·□B

## SNMP ,đ\□-.,.é

SNMP fT□[frfX,í□A[Windows NT TCP/IP 'g,Ý□ž,Ýf|fvfVf#f"] f\_fCfAf□fO f\_{fbfNfX,Á□A'í%ž,.,é|fvfVf#f",ì  
f`fFfbfN f\_{fbfNfX,đf|f",.É,.,é,Æ'g,Ý□ž,Ü,ê,Ü,·□BSNMP fT□[frfX f\ftfgfEjFfA,đfRf"fSf...  
□[f^,É'g,Ý□ž,ñ,¾CEã,í□ASNMP ,ª" @□ì,.,é,æ,α,É□A—LCEø,È□î•ñ,đŽg,Á,Ä SNMP ,ì\  
□-.,đ□s,í,È,~,ê,Î,È,è,Ü,¹,ñ□B

SNMP ,đ\□-.,.é,É,í□A□□□[fj fRf"fSf...□[f^,ì Administrators  
fOf<□[fv,í□f"fo□[,Æ,μ,Äf□fOf|f",μ,È,~,ê,Î,È,è,Ü,¹,ñ□B

SNMP □□-□î•ñ,æ,è□A fRf~f...fj fefB,Æfgf%ofbfv'—□M□æ,ªŽ•É,³,ê,Ü,·□B



**fRf~f...fj fefB,Æ,í□ASNMP fT□[frfX,đŽÀ□s,μ,Ä,ç,éfT□[fo□[,ª' @,μ,Ä,ç,éfzfXfg fOf<□[fv,ì,±  
,Æ,Ä,·□BSNMP ,đŽg—p,μ,Ä,ç,é Windows NT fRf"fSf...□[f^,ªfgf%ofbfv,đ'—□M,.,é□æ,Æ,μ,Ä□A1  
,Ä,Ü,½,í•j□",íRf~f...fj fefB,đŽw'è,.,é,±,Æ,ª,Ä,«,Ü,·□BfRf~f...fj fefB-¼,í□Afgf%ofbfv,ì—□MŽž,É□ASNMP  
fOfPfbfg"à,ÉŽù,ß,ç,ê,Ü,·□B**

SNMP fT□[frfX,í□A□î•ñ,đ<□,ß,é—v<□,đŽó,~Žæ,Á,½,Æ,«□A,»,è,ª³,μ,çfRf~f...fj fefB-¼,đŠÜ,ñ,Ä,ç  
,É,ç□é□#,â□A fT□[frfX,đ" F,ß,ç,ê,Ä,ç,éfzfXfg-¼,Æ^è'v,μ,È,ç□é□#,É□Afgf%ofbfv'—□M□æ,Éfgf%ofbfv,đ'—  
□M,μ,Ä—v<□,ì" F□Ø,ªŽ,"s,μ,½,±,Æ,đ'm,ç,¹,é,±,Æ,ª,Ä,«,Ü,·□B



**fgf%ofbfv'—□M□æ,Æ,í□ASNMP fT□[frfX,ª□Afgf%ofbfv,đ'l'đ,μ,½fRf~f...fj fefB-¼,Æ,Æ,à,É'—  
□M,.,é□æ,ízfXfg-¼,Ü,½,í IP fAfhfCEfX,ì,±,Æ,Ä,·□B**

SNMP ,đŽg,Á,Ä"□CEv□î•ñ,đŽù□W,μ,½,ç,ª□A fRf~f...fj fefB,âfgf%ofbfv,ìŽ~•É,É,í□^Ó,đ•¥,ç,½,-  
,É,ç□é□#,ª ,è,Ü,·□B,±,ì,æ,α,É□é□#,É,í□ASNMP fT□[frfX,đ\□-.,.é,Æ,«□A fRf~f...fj fefB-  
¼,É□gpublic□h,đŽw'è,Ä,«,Ü,·□B

ŠÖ~A□€-Ú



SNMP fT□[frfX,đ\□-.,.é



SNMP fZfLf...fŠ fefB,đ\□-.,.é



SNMP fG□[fWfFf"fg□î•ñ,đ\□-.,.é

**SNMP fT[fxfX,đ□□-,.,é**

**SNMP fT[fxfX,đ□□-,.,é,É,í**

1. fRf“fgf□□[f< pflf<,Á [flfbfgf□□[fN] ft□[fefBfŠfefB,đ<N“ @,μ,Ü,·□B[flfbfgf□□[fN,ì□Ý’è] f\_fCfAf□fO f{fbfNfX,â\Žì,³,è,Ü,·□B[‘g,Ý□ž,Ü,è,Ä,ç,éflfbfgf□□[fN flftfgfEfffA] ^è—,Á□ASNMP fT□[fxfX] ,đ’í,đ,μ□A[□□-] f{f^f“,đfNfŠfbfN,μ,Ü,·□B[SNMP fT□[fxfX,ì□□-] f\_fCfAf□fO f{fbfNfX,â\ Žì,³,è,Ü,·□B
  2. ,±,ìfRf“fsf...□[f^,âfgf%ofbfv,đ’—□M,·,é□æ,ìfRf~f...fjfefB,đ,»,è,¼,èŽw’è,·,é,É,í□A[fRf~f...fjfefB-¼] f{fbfNfX,ÉfRf~f...fjfefB-¼,đ“ü—í,μ,Ü,·□BfRf~f...fjfefB-¼,đ“ü—í,μ,½□Eâ□A[‘Ç%Á] f{f^f“,đfNfŠfbfN,μ,Ä□AfRf~f...fjfefB-¼,đ□¶’æ,ì [fgf%ofbfv,Æ,Æ,à,É’—□M,·,éRf~f...fjfefB-¼] ^è —,É^Ú“ @,³,¹,Ü,·□B  
‘É□□A,·,x,Ä,ìfzfXfg,í□gpublic□h,É’ @,μ,Ü,·□Bpublic ,í□A,·,x,Ä,ìfzfXfg,ì<æ’ÉfRf~f...fjfefB,đ•\ ,·w□€-¼,Ä,·□B^è—, ©,çfGf“fgfŠ,đ□í□œ,·,é,É,í□A□í□œ,μ,½,çfGf“fgfŠ,đ’í,đ,μ□A[□í□œ] f{f^f“,đfNfŠfbfN,μ,Ü,·□B
- ‘□ : fRf~f...fjfefB-¼,Ä,í□A’â•¶Žš,Æ□-•¶Žš,â<æ•É,³,è,Ü,·□B
3. fgf%ofbfv,đ’—□M,·,éŠefRf~f...fjfefB,É’í,μ,ÄfzfXfg,đŽw’è,·,é,É,í□AfRf~f...fjfefB,đ’Ç %Á,μ,½□Eâ□A,»,ìfRf~f...fjfefB-¼,đ^è—,Á<²•\Žì,³,¹,½□ó’Ô,Á□A[IP fzfXfg/fAfhfçfX,Ü,½,í IPX fAfhfçfX] f{fbfNfX,ÉfzfXfg-¼,đ“ü—í,μ,Ü,·□BŽÝ,É□A[‘Ç%Á] f{f^f“,đfNfŠfbfN,μ,Ä□AfzfXfg-¼,Ü,½,í IP fAfhfçfX,đ□¶’æ,ì [□ ,ìfgf%ofbfv—□M□æ] ^è—,É^Ú“ @,³,¹,Ü,·□B  
^è—, ©,çfGf“fgfŠ,đ□í□œ,·,é,É,í□A□í□œ,μ,½,çfGf“fgfŠ,đ’í,đ,μ□A[□í□œ] f{f^f“,đfNfŠfbfN,μ,Ü,·□B
  4. SNMP fT□[fxfX,Á’Ç%ÁfZfLf...fŠfefB,đŽg—p%Á“\,É,·,é,É,í□A[fZfLf...fŠfefB] f{f^f“,đfNfŠfbfN,μ,Ü,·□B’Ç%ÁfZfLf...fŠfefB,ì□□-Žè□±,É,Á,ç,Ä,í□ASNMP fZfLf...fŠfefB,đ□□ □-,·,é,đŽQ□Æ,μ,Ä,,¾,¾,ç□B
  5. fG□[fWfFf“fg□î•ñ (ft□[fU□[,Æ□é□Š,É,Á,ç,Ä,ìfRf□f“fg□A,“,æ,Ñft□[fxfX] ,đŽw’è,·,é,É,í□A[fG□[fWfFf“fg] f{f^f“,đfNfŠfbfN,μ,Ü,·□BfG□[fWfFf“fg□î•ñ,ìŽw’è,É,Á,ç,Ä,í□ASNMP fG□[fWfFf“fg□î•ñ,đ□□□-,·,é,đŽQ□Æ,μ,Ä,,¾,¾,ç□B
  6. □□-□í<Æ,â,·,x,ÄŠ @—¹,μ,½,ç□A[OK] f{f^f“,đfNfŠfbfN,μ,Ü,·□B[flfbfgf□□[fN,ì□Ý’è] f\_fCfAf□fO f{fbfNfX,â\Žì,³,è,Ü,·ç□A[OK] f{f^f“,đfNfŠfbfN,μ,Ü,·□B

,±,è,Ä□AMicrosoft SNMP fT□[fxfX,ì□□-,âŠ @—¹,μ□AfT□[fxfX,đŠ]Žn,Ä,«,é□ó’Ô,É,È,è,Ü,μ,½□BfRf“fsf... □[f^,đ□Ä<N“ @,·,é•K—v,í, ,è,Ü,¹,ñ□B



**SNMP fzfLf...fšfefB,đ□□-,-,é**

SNMP fzfLf...fšfefB,É,æ,è□Afrf“fsf...□[f^,ª,Ç,lfRf~f...fjfefB,“ ,æ,ÑfzfXfg,©,ç—  
v<□,đŽó,“ü,é,é,©,đŽw'è,Á,«,Ü,·□B,Ü,½□A“F,ß,ç,è,Ä,ç,É,çfRf~f...fjfefB,Ü,½,lfzfXfg,©,ç□î•ñ,ì—v<□,ª, ,Á  
,½,Æ,«,É□A“F□Øfgf%öbfv,đ'—□M,·,é,©,Ç,æ,©,đŽw'è,Á,«,Ü,·□B

**SNMP fzfLf...fšfefB,đ□□-,-,é,É,í**

1. frf“fgf□□[f< fpf]f<,Á [flfbfgf□□[fn] ft□[fefBšfefB,đ<N“ ® ,µ,Ü,·□B[flfbfgf□□[fn,ì□Y'è] f\_fCfAf□fO  
f{fbfNfX,ª•\Žì,ª,è,Ü,·□B[‘g,Y□ž,Ü,è,Ä,ç,éflfbfgf□□[fn f\ftfgfEfffA] ^è—,©,ç□A[SNMP f□□[frfX]  
,đ'í,đ,µ□A[□□-] f{f^f“,đfNfšfbfN,µ,Ü,·□B[SNMP f□□[frfX,ì□□-] f\_fCfAf□fO f{fbfNfX,ª•\  
Žì,ª,è,Ü,·□B
  2. [fzfLf...fšfefB] f{f^f“,đfNfšfbfN,µ,Ü,·□B[SNMP fzfLf...fšfefB,ì□□-] f\_fCfAf□fO f{fbfNfX,ª•\  
Žì,ª,è,Ü,·□B
  3. “F□Ø,ìŽ,“s,ª, ,Á,½,Æ,«,Éfgf%öbfv,đ'—□M,µ,½,ç□è□±,í□A[“F□Øfgf%öbfv,đ'—□M] f`fFbfN  
f{fbfNfX,đfif“,É,µ,Ü,·□B
  4. [frf~f...fjfefB-¼] f{fbfNfX,É□A,Ç,lfRf~f...fjfefB,©,ç,ì—v<□,đŽó,“ü,é,é,©,đŽì,frf~f...fjfefB-  
¼,đ“ü—í,µ,Ü,·□Bfrf~f...fjfefB-¼,đ“ü—í,µ,½Çæ□A[‘Ç%Á] f{f^f“,đfNfšfbfN,µ,Ä□Afrf~f...fjfefB-  
¼,đ□¶'æ,ì [Žó,“ü,é,éfrf~f...fjfefB-¼] ^è—,É^U“® ,ª,¹,Ü,·□B
- SNMP f□□[frfX,æfzfXfg,©,ç,ì—v<□,đŽó,“ü,é,é,É,í□A,» ,lfzfXfg,ª,±,ì^è—,É•\Žì,ª,è,Ä,ç,éfrf~f...  
fjfefB,É® ,µ,Ä,ç,É, ,è,î,É,è,Ü,¹,ñ□B'É□í□A,·,×,Ä,lfzfXfg,í□gpublic□h,É® ,µ,Ü,·□Bpublic  
,í□A,·,×,Ä,lfzfXfg,Á<æ'É,lfRf~f...fjfefB,đ•\,•W□€-¼,Ä,·□B^è—  
,©,çGf“fgfš,đ□í□æ,·,é,É,í□Afgf“fgfš,đ'í,đ,µ□A[í□æ] f{f^f“,đfNfšfbfN,µ,Ü,·□B
5. ,·,×,Ä,lfzfXfg,©,ç SNMP fpfPfbfg,đŽó,“ü,é,é,©□Ažw'è,µ,½zfzXfg,©,ç,¾,“ SNMP  
fpfPfbfg,đŽó,“ü,é,é,©,đ'í,đ,µ,Ü,·□B



[·,×,Ä,lfzfXfg,©,ç,ì SNMP fpfPfbfg,đŽó□M,·,é] flfvVf†f“ f{f^f“,đ'í,đ,·,é,Æ□A—□MCE³,ì ID  
,É,æ,Á,Ä SNMP fpfPfbfg,ª•““Ü,ª,è,é,±,Æ,í, ,è,Ü,¹,ñ□B[ŽY,lfzfXfg,©,ç,ì SNMP fpfPfbfg,ì,Yžó□M,·,é]  
flfvVf†f“,lfzfXfg^è—,ì-³CEø,É,É,è,Ü,·□B



[ŽY,lfzfXfg,©,ç,ì SNMP fpfPfbfg,ì,Yžó□M,·,é] ,đ'í,đ,µ,½□è□±,í□AfgfXfg^è—,É•\Žì,ª,è,Ä,ç  
,ézfzXfg,©,ç,ì SNMP fpfPfbfg,¾,“ ,đŽó,“ü,é,Ü,·□B[zfzXfg/fAfhfCEfX,Ü,½,ì IPX fAfhfCEfX] f{fbfNfX,É□A—  
v<□,đŽó,“ü,é,ézfzXfg-¼□A,Ü,½,lfAfhfCEfX,đ“ü—í,µ,Ü,·□BŽY,É□A[‘Ç%Á] f{f^f“,đfNfšfbfN,µ,Ä□AfgfXfg-  
¼,Ü,½,lfAfhfCEfX,đ□¶'æ,ì^è—,É^U“® ,ª,¹,Ü,·□B^è—  
,©,çGf“fgfš,đ□í□æ,·,é,É,í□A□í□æ,µ,½,çfGf“fgfš,đ'í,đ,µ□A[í□æ] f{f^f“,đfNfšfbfN,µ,Ü,·□B

6. [OK] f{f^f“,đfNfšfbfN,µ,Ü,·□B[SNMP f□□[frfX,ì□□-] f\_fCfAf□fO f{fbfNfX,ª□A“x\Žì,ª,è,Ü,·□B  
fG□[fWfFf“fg□î•ñ (ft□[fU□[□A□è□š,ÉšÖ,·,éfrf□f“fg,“ ,æ,Ñft□[frfX] ,đŽw'è,·,é,É,í□A[fG□[fWfFf“fg]  
f{f^f“,đfNfšfbfN,µ,Ü,·□BfG□[fWfFf“fg□î•ñ,ì□□- ,É,Á,ç,Ä,í□ASNMP fG□[fWfFf“fg□î•ñ,đ□  
□- ,·,é,đŽQ□Æ,µ,Ä, ,¾,ª,ç□B

7. □□-□í<Æ,đ,·,×,Äš® —¹,µ,½,ç□A[OK] f{f^f“,đfNfšfbfN,µ,Ü,·□B[flfbfgf□□[fn,ì□Y'è] f\_fCfAf□fO  
f{fbfNfX,ª□A“x\Žì,ª,è,½,ç□A[OK] f{f^f“,đfNfšfbfN,µ,Ü,·□B  
,±,è,Ä□AMicrosoft SNMP f□□[frfX,Æ SNMP fzfLf...fšfefB,ì□□- ,ªš® —  
¹,µ□Aft□[frfX,đš]žn,Á,«,é□ó'Ó,É,É,è,Ü,µ,½□Bfrf“fsf...□[f^,đ□Ä<N“ ® ,·,é•K—v,í, ,è,Ü,¹,ñ□B

**SNMP fG[fWfFf“fgî•ñ,ð\¬-,·,é**

SNMP fG[fWfFf“fgî•ñ,É,íAft[fU[“,æ,ÑfRf“fsf...[f^,ì•—  
□“l,É”z’u□ê□Š,ÉŠÖ,·,éRf□f“fg,ð<L□q,μ,½,è□A•ñ□□,·,éft□[frfX,ìŽí—  
p,ðŽwŽì,μ,½,è,Á,«,·,Ü,·□B•ñ□□,Á,«,éft□[frfX,ìŽí—p,í□Afrf“fsf...[f^,ì□□¬,É,æ,Á,Ä^Ü,È,è,Ü,·□B

**SNMP fG[fWfFf“fgî•ñ,ð\¬-,·,é,É,í**

1. fRf“fg□□[f< fpf|f<,Á [f|fbfgf□□[fN] ft□[fefBfŠfefB,ð<N“® ,μ,Ü,·□B[f|fbfgf□□[fN,ì□Ý’è) f\_fCfAf□fO f{fbfNfX,ª•\Žì,³,è,Ü,·□B[‘g,Ý□ž,Ü,è,Ä,ç,é|fbfgf□□[fN f|ftfgfE|fFA] ^è—,Á□A[SNMP ft□[frfX] ,ð’íð,μ□A[□□¬] f{f^f“,ðfNfŠfbfN,μ,Ü,·□B[SNMP ft□[frfX,ì□□¬] f\_fCfAf□fO f{fbfNfX,ª•\ Žì,³,è,Ü,·□B
2. [fG[fWfFf“fg] f{f^f“,ðfNfŠfbfN,μ,Ü,·□B[SNMP fG[fWfFf“fg] f\_fCfAf□fO f{fbfNfX,ª•\Žì,³,è,Ü,·□B
3. [^A—□□æ] f{fbfNfX,É□Afrf“fsf...[f^,ìft□[fU□[-¼,ð□A[□ê□Š] f{fbfNfX,ÉfRf“fsf...[f^,ì•— □“l,É”z’u□ê□Š,ð“ü—l,μ,Ü,·□B,±,è,ç,íRf□f“fg,Á, ,è□Afe|fXfg,Æ,μ,Ä,íŽg—p,Á,«,·,ª□A— ,,ß□ž,Ý□šÇä•¶Žš,ðŠÜ,ß,é,±,Æ,í,Á,«,·,Ü,¹,ñ□B
4. [ft□[frfX] fOf<□[fv f{fbfNfX,Á□A•ñ□□,·,éft□[frfX,ð’íð,μ,Ü,·□B,»,ì Windows NT fRf“fsf... □[f^,ª•ñ<Ý,·,é|fbfgf□□[fN<@“\,ðŽì,·f{fbfNfX,ð,·,×,Ä|f|“,É,μ,Ü,·□BŽg—p,Á,«,éft□[frfX,ðŠÇ— □,·,é,É,í□ASNMP ,ª,±,ì)î•ñ,ðŽ□,Á•K—v,ª, ,è,Ü,·□B

fufŠfbfW,Ü,½,í,í□[f^□[.È,Ç,ì,æ,µ,È’Ç%ooÀ,ì TCP/IP ft□[frfX,ð’g,Ý□ž,ñ,Á,ç,é□ê□#,í□ARFC 1213 ,ðŽQ□Æ,μ,Ä,¾,¾,¾,ç□B

•—□’w  
,±,ì Windows NT fRf“fsf...[f^,ª□Afrfšfs□[f^,È,Ç,ì,æ,µ,È□A•—□ffofCfX,ðŠÇ— □,·,é□ê□#,É,í□A,±,ìf fFfbfN f{fbfNfX,ðf|f“,É,μ,Ü,·□B

f□[f^fŠf“fN/ftfuf|fbfgf□□[fN  
,±,ì Windows NT fRf“fsf...[f^,ª□AfrfšfbfW,È,Ç,ì TCP/IP ftfuf|fbfgf□□[fN,âff□[f^fŠf“fN,ðŠÇ— □,·,é□ê□#,í□A,±,ìf fFfbfN f{fbfNfX,ðf|f“,É,μ,Ü,·□B

fCf“f^□[f|fbfg  
,±,ì Windows NT fRf“fsf...[f^,ð□AIP fQ□[fgfE|fFC,Æ,μ,ÄŽg—p,·,é□ê□#,í□A,±,ìf fFfbfN f{fbfNfX,ðf|f“,É,μ,Ü,·□B

fGf“fh fc□[ fGf“fh  
,±,ì Windows NT fRf“fsf...[f^,ð□AIP fzfXfg,Æ,μ,ÄŽg—p,·,é□ê□#,í□A,±,ìf fFfbfN f{fbfNfX,ðf|f“,É,μ,Ü,·□B,±,ìf fFfbfN f{fbfNfX,í□AWindows NT ,ð’g,Ý□ž,þ□Ü,É□A•K, ,f|f“,É,·,é•K—v,ª, ,è,Ü,·□B

fAfvfŠfP□[fvf#f“  
,±,ì Windows NT fRf“fsf...[f^,É□A“dŽqf□□[f<,È,Ç,ì TCP/IP ,ðŽg— p,·,éAfvfŠfP□[fvf#f“,ð’g,Ý□ž,þ□ê□#,í□A,±,ìf fFfbfN f{fbfNfX,ðf|f“,É,μ,Ü,·□B,± ,ìf|fvfVf#f“,í□AWindows NT ,ð’g,Ý□ž,þ□Ü,É□A•K, ,f|f“,É,·,é•K—v,ª, ,è,Ü,·□B

5. [OK] f{f^f“,ðfNfŠfbfN,μ,Ü,·□B
  6. [SNMP ft□[frfX,ì□□¬] f\_fCfAf□fO f{fbfNfX,ª□A“x\Žì,³,è,½,ç□A[OK] f{f^f“,ðfNfŠfbfN,μ,Ü,·□B[f|fbfgf□□[fN,ì□Ý’è) f\_fCfAf□fO f{fbfNfX,ª□A“x\Žì,³,è,½,ç□A[OK] f{f^f“,ðfNfŠfbfN,μ,Ü,·□B
- ,±,è,Á□ASNMP ,ðŽg—p,Á,«,é□ó’Ô,É,È,è,Ü,μ,½□Bfrf“fsf...[f^,ð□A<N“®,·,é•K—v,í, ,è,Ü,¹,ñ□B



## TCP/IP ,iflfbfgf[]fNŠT”O

,±,±,Á,Í[]AInternet fvf[]fgfRf<’ìCEn,ìŠe[]\[]—v’f,Æ IP fAfhfCEfXŽw’è,É,Á,ç,Ä[]à-¾,μ,Û,·[]B,±  
,ê,ç,ÉŠÖ,·,é,æ,è[]Ú,μ,ç[]î•ñ,É,Á,ç,Ä,Í[]A[]wInternet networking with TCP/IP[]x[]AVolume I, by Douglas E.  
Comer: Prentice Hall, 1991 (-M-ó: []wTCP/IP ,É,æ,éflfbfgf[]fN[]’z Vol.†T[]x[]A’^ä[]f[]A’í-{}”Ž”V-ó[]A<α—  
S[]o”Á[]A1993) ,É,ç,ìŠÖ~A•¶CE£,ðŽQ[]Æ,μ,Ä,,¾,¾,ç[]BŽŸ,ì[]€-Ú,Á,Í[]AMicrosoft TCP/IP ,ì 2 ,Á,ì[]d—v,È<@”\  
,Á, ,é[]ADHCP (Dynamic Host Configuration Protocol; “®“lfzfXfg[]\[]—fvf[]fgfRf<) ,Æ WINS (Windows  
Internet Name Service; Windows fCf“f^[]flfbfg f[]f[]€ fT[]f[]rfX) ,ìŠT”O,É,Á,ç,Ä[]à-¾,μ,Û,·[]B,Û,½[]ADNS  
(Domain Name System; fhf[]fCf“ f[]f[]€ fv[]f[]Xfef€) ,lfAfhfCEfXŽw’è,ì•û-@[]A, ,æ,Ñ TCP/IP ,ð Windows NT  
flfbfgf[]fN fA[]fLfefNf’ff,É“K%ž,¾,¾,é•û-@,É,Á,ç,Ä,à[]à-¾,μ,Û,·[]B

ŽŸ,ì[]€-Ú,É,Á,ç,Ä[]à-¾,μ,Û,·[]B



[Internet fvf\[\]fgfRf<’ìCEn](#)



[IP fAfhfCEfXŽw’è](#)



[DHCP \(“®“lfzfXfg\[\]\\[\]—fvf\[\]fgfRf<\)](#)



[WINS ,Æ Windows flfbfgf\[\]fN,ì-¾’O%ðCE^](#)



[SNMP](#)



[TCP/IP ,Æ Windows flfbfgf\[\]fN](#)



**TCP ("`'—□\$CEäfvf□fgfRf<) ,Æ IP (fCf" f^□[flfbfg fvf□fgfRf<)**

TCP (Transmission Control Protocol; "`'—□\$CEäfvf□fgfRf<) ,Æ IP (Internet Protocol; fCf" f^□[flfbfg fvf□fgfRf<) ,í□AIP fvf□fgfRf<'íCEn,É'©,·,é,ç,,Ä,©,lfvf□fgfRf<,ì,κ,ζ,ì 2 ,Ä,Ä,μ,©, ,è,Ü,<sup>1</sup>,ñ□BIP ,í□ATCP/IP ftf@f~fŠ"à,ì,Ü,©,ì,·,x,Ä,lfvf□fgfRf<,ì,½,β,É□AfpfPfbfg"z□M,ð□s,κfvf□fgfRf<,Ä, ,è□Afrf"fsf...□[f^ f□[f^,É'í,μ,Äfrf|fNfVf+f" fCEfXCE^,ì"z□MfVfXfefe€,ð'ñ<ÿ,μ,Ü,·□B,·,É,í,ζ□AIP fpfPfbfg,<sup>a</sup>,»,'—□M□æ,É"í,,± ,Æ,í•Ü□Ø,<sup>3</sup>,è,Ü,<sup>1</sup>,ñ,μ□A,Ü,½□A'—□M,<sup>3</sup>,è,½□#□~ ,ÄŽó□M,Ä,« ,é•Ü□Ø,à, ,è,Ü,<sup>1</sup>,ñ□BIP fvf□fgfRf<,lf` fFfbfNfTf€<@"\,í□AIP fwfbf\_□[,ì□@□#□<,ð•Ü□Ø,·,é,¾,¯ ,Ä,·□B,μ,½,<sup>a</sup>,Ä,Ä□AIP fpfPfbfg,ÉŠÜ,Ü,è,Ä,ç,éff□[f^ (,·,æ,Ñ□Afff□[f^,ì•Ä,Ñ) ,É'í,·,é□Ó"C,í□AZg—p,<sup>3</sup>,è,é,æ,è□ã^Ê,lfvf□fgfRf<,<sup>a</sup>• %o,κ,±,Æ,É,È,è,Ü,·□B

□Ä,à^ê"E"í,È□ã^ÊfCEfxf< IP fvf□fgfRf<,í TCP ,Ä,·□BTCP ,í□A□M—Š□<,ì, ,é□A□Ú'±fx□[fX,lfvf□fgfRf<,ð IP □ã,É (,Ü,½,ì IP "à,ÉfjfvfZf<%o»,μ,Ä) 'ñ<ÿ,μ,Ü,·□BTCP ,í□AfpfPfbfg,ìŠmŽÄ,É"z□M,ð•Ü□Ø,μ□Aff□[f^, <sup>a</sup>□<sup>3</sup>,μ,ç•Ä,Ñ,Ä'—□M,<sup>3</sup>,è,é,æ,κ,É,μ,Ü,·□B,Ü,½□ATCP/IP ,í□AfpfPfbfg fwfbf\_□[ ,Æ,» ,ìff□[f^,ì—¼•ù,ì□<sup>3</sup>Šm,<sup>3</sup>,ðCEÿ□,·,é` fFfbfNfTf€<@"\ ,à'ñ<ÿ,μ,Ü,·□B"``'—'†,É□Aflfbfgf□□[fN,Ä TCP/IP fpfPfbfg, <sup>a</sup>"j'<sup>1</sup>,μ,½,è•'Ž,μ,½,è,Æ,ç,Ä,½□áŠQ, <sup>a</sup>"- □¶,·,é,Æ□ATCP ,í□áŠQ,ì, ,éfpfPfbfg,ð□Ä'—□M,μ,Ü,·□B,±,ì,æ,κ,È□M—Š□<,ì□,<sup>3</sup>,ì,½,β,É□ATCP/IP ,í□A fZfbfVf+f" fx□[fX,ìff□[f^"``'—□A fNf%ofCfAf"fg fT□[fo□[ fAfvfŠfP□[fVf+f"□A,·,æ,Ñ" dŽqf□□[f<,È,Ç,ìŠìŠ<sup>2</sup>fT□[rfX,ÉŽg,í,è,Ä,ç,Ü,·□B

,μ,©,μ□A,±,ì□M—Š□<,É,í'ã□ž, <sup>a</sup>"o,ç,Ü,·□BTCP fwfbf\_□[ ,É,í□A□î•ñ,ð□<sup>3</sup>,μ,ç•Ä,Ñ,Ä"``'—,·,é,½,β,É'Ç %oÁfrfbfg,ðŽg,κ•K—v,<sup>a</sup>, ,è,Ü,·,μ□A,Ü,½□ATCP fwfbf\_□[ ,·,æ,ÑfpfPfbfg f□[f^,ì—¼•ù,ì□M— Š□<,ð•Ü□Ø,·,é,½,β,É<□Sf` fFfbfNfTf€ ,ðŽg,κ•K—v,à, ,è,Ü,·□B,Ü,½□Aff□[f^,ð□<sup>3</sup>,μ,- "z□M,·,é,É,í□Aff□[f^,ð□<sup>3</sup>,μ,Žó□M,μ,½,±,Æ,ðŠm" F,·,éŠm" F%ož"š,à TCP/IP ,É,í•K—v,Æ,È,è,Ü,·□B

,±,ìŽí,ìŠm" F%ož"š (ACK) ,í□A'Ç%oÁfgf%oftfBfbfN,ð□¶□—,·,é,ì,Ä□Aff□[f^,ì□M— Š□<,í□,Ü,Ä,Ä,àff□[f^ ,lfXf<□[fvfbfg,íCE,μ,Ü,·□B'ã"¼,lfzfXfg,í□AfpftfH□[f}f" fX,Ö,ì %oe<ζ,ðCE,·,ç,·,½,β,É□A fZfOf□[f" fg 1 ,Ä,·,« ,©□AACK f^fCf€fAfEfGŽžŠÖ,ìCe%oβCEã,ÉŠm" F%ož"š,ð'— □M,μ,Ü,·□B

## UDP (ft□[fU□[ ff□[f^fOf%of€ fvf□fgfRf<)

□M—Š□« ,ª•K—v•s%oÁCE‡,Á,í,È,ç□ê□‡,í□ATCP □€< ,ì UDP (User Datagram Protocol; ft□[fU□[ ff□[f^fOf %of€ fvf□fgfRf< ) ,í□A”z□M,à”z□MfjpfPfbfg,ì□³,μ,ç•À,Ñ,à•Ú□Ø,μ,È,ç (IP ,ÉŽ—,Ä,ç,Ü,·) fRfjlfNfVf‡f”fCEfXCE^ff□[f^fOf%of€ fT□[fxfX ,ð’ñ<ÿ,μ,Ü,·□B□ã^ÊfCEfxf< fvf□fgfRf<,Ü,½,ÍfAfvfŠfP□[fVf‡f” ,ª□AUDP/IP ,É’Ç%oÁ,μ,Ä□A□M—Š□« ,ð•Ú□Ø,·,é<@□\ ,ð’ñ<ÿ,·,é□ê□‡,ª ,è,Ü,·□BUDP ff□[f^ f`fFfbfNfTf€ ,ÍfjfvfVf‡f” ,Á ,è□A”ñ□í,É□M— Š□« ,ª□,çfjfbfgf□□[fN□ã,Á□Afvfbfgf□□[fNŽ’CE¹,â□^—□ŽŽŠÖ,ð•K—v^É□ã,É”i,â,ª,È,ç,Áff□[f^ ,ðCEðŠ·,·,é•ù- @,ð’ñ<ÿ,μ,Ü,·□BUDP f`fFfbfNfTf€ ,í□Afwfbf\_□[ , ,æ,Ñff□[f^ ,ì—¼•ù,ðCEÿ□Ø,μ,Ü,·□BUDP fvf□fgfRf<,Á,í ACK ,à<□s,Á,í,È,·□A□ã^ÊfCEfxf< fvf□fgfRf<,É^í,È,ç,ê,Ä,ç,Ü,·□B





## IP fAfhfCEfXŽw'è

fzfXfg,Æ,íAflfbfgf□□[fN,É□Ú'±,³,è,½□ATCP/IP ,ðŽg—p,·,é" C^Ó,ìfffofCfX,Á,·□BzfXfgŠÔ,ÁfpfPfbfg,ð□³,μ,- Žó"z□M,·,é,½,β,É□ATCP/IP ,í□Aft□[fU□[,²'ñ<Ÿ,·,é IP fAfhfCEfX□Aftfufifbfg f}fXfN□A,·,æ,ÑffftfHf<fg fQ□[fgfEfFfC,ì 3 ,Á,ì□î•ñ,ðŽg—p,μ,Ü,·□B

fifbfgf□□[fNŠÇ—□ŽÒ,í□Afrf"fsf...□[f^,É TCP/IP ,ð□□—,·,é,½,β,É□A,±,è,ç,ìŠe□î•ñ,ð'ñ<Ÿ,μ,Ü,·□BDHCP fT□[fo□[,²'¶□Ÿ,·,éfifbfgf□□[fNä,ì Windows NT ft□[fU□[,í□AZ©" "®fvfXfef€□□—,ð—~—p,Á,«,é,ì,Á□ATCP/IP fpf%of□□[f^,ì□□—,ðŽè" ©,Á□s,²•K—v,í, ,è,Ü,¹,ñ□BŽŸ,ì□€—Ú,Á,í□AIP fAfhfCEfX□Aftfufifbfg f}fXfN□A,·,æ,Ñ IP fQ□[fgfEfFfC,É,Á,ç,Á□Ú,μ,□à-¾,μ,Ü,·□B



IP fAfhfCEfX



fifbfgf□□[fN ID,ÆfzfXfg ID



fTfufifbfg f}fXfN



f<□[fefBf"fo,Æ IP fQ□[fgfEfFfC



RAS ,ì IP fAfhfCEfXŽw'è

ŠÖ~A□€—Ú

DHCP (" "®"fzfXfg□□—fvf□fgfRf<)

## IP fAfhfCEfX

TCP/IP flfbfgf□□[fN□ä,lfzfXfg fCf“f^□[ftfFfCfX (,Ü,½,lfm□[fh) ,í,·,x,Ä□A^ê^Ó,ì IP fAfhfCEfX,ÄŽ·•Ê,³,ê,Ü,·□B,±,lfAfhfCEfX,í□Aflfbfgf□□[fN□ä,lfm□[fh,ìŽ·•Ê,ÉŽg— p,³,ê□A,Ü,½□AfCf“f^□[flfbfgf□□[fN,lf<□[fefBf“fOî•ñ,ìŽw`è,É,àŽg—p,³,ê,Ü,·□BIP fAfhfCEfX ,í□Afrf“fsf... □[f^,ð□ATCP/IP flfbfgf□□[fN‘S‘ì,Å^ê^Ó,ì 32 frfbfg fAfhfCEfX,Æ,μ,ÄŽ·•Ê,μ,Ü,·□B‘É□í□AIP fAfhfCEfX,í□Afhfbfg<æ□Ø,è 10 □i•\<L,Å•\,μ,Ü,·□B,±,ì•\<L-@,Å,í□AIP fAfhfCEfX,ìŠeflfNfefbfg (8 frfbfg□A,Ä,Ü,è 1 fofCfg) ,ð 10 □i‘l,Å•\,μ□AfsfŠfJfh,Å<æ□Ø,Å,Å•\,μ,Ü,·□BIP fAfhfCEfX,ì—á,ðŽÿ,ÉŽ!,μ,Ü,·□B 102.54.94.97

□d—v : IP fAfhfCEfX,í□A‘ŠCEÿ□Ú‘± ,³,ê,½flfbfgf□□[fN□ä,lfm□[fh,ðŽ·•Ê,·,é,ì,Å□AfCf“f^□[flfbfgf□□[fN□ä,ìŠefVfXfef€ ,É,í□A,»),ì‘Á‘è,lfJfbfgf□□[fN,Å—LCEø,È^ê^Ó,ì IP fAfhfCEfX,ðŠ,,è“- ,Ä,È, ,é,ì,È,è,Ü,¹,ñ□B

ŠÖ~A□€-Ú

 flfbfgf□□[fN ID,ÆfzfXfg ID

 fTfufJfbfg\_f}fXfN

**flfbfgf[]fN ID ,ÆfzfXfg ID**

IP fAfhfCEfX, íP^è, ì, Á, ·, ðA, », ±, É, ÌfRf“fsf...[]f^ ^, Ìfifbfgf[]fN ID ,ÆfzfXfg (, ·, È, í, ù, V, fX, fef€) ID , ì 2 Ží—  
p, Ì, ð, ñ, ðŠÜ, Ü, è, Ä, ç, Ü, ·, []B



flfbfgf[]fN ID , íA fRf“fsf...[]f^ ^ fOf<[]fv, ·, æ, Ñ“~ , ¶~ —[]fifbfgf[]fN ðä, È^È^u, µ, Ä, ç  
, é, Ü, ©, ÌfffofCfX, ðŽ~ ·É, µ, Ü, ·, []B fCf“f^ []fifbfgf[]fN (·; []” , Ìf[][]fjfk fGfŠfA flfbfgf[]fN, Ä[]  
[]-, ð, è, é, Ìfifbfgf[]fN) , È, ÌAŠeflfbfgf[]fN, È, í, ·, é^è^Ó, Ìfifbfgf[]fN ID , ð, ¶, µ, Ü, ·, []B



fzfXfg ID , íA“Á^è, Ìfifbfgf[]fN ID , È^® , ·, éfRf“fsf...[]f^ ^, ðŽ~ ·É, µ, Ü, ·  
(fzfXfg, Æ, ÌA fflfbfgf[]fN, È, Ü^±, ð, è TCP/IP , ðŽg—p, µ, Ä, ç, é”C^Ó, ÌfffofCfX, Ä, ·)[]B

fpfufŠfbfN, È Internet , È, Ü^±, ·, é, Ìfifbfgf[]fN, íA ADDN-NIC (“ú- {, Á, í JPNIC) , ©, ç, Ç, È, ð”F, Ìfifbfgf[]fN ID  
, ð“üŽè, µ, Ä, AIP flfbfgf[]fN ID , Ì^è^Ó, ðŠm^Ü, µ, È, ·, Ä, í, È, è, Ü, ð, ñ, B flfbfgf[]fN ID  
, ðŽó, ~Žæ, Á, ½, ç, A f[][]fjk ffbfgf[]fN, ÌŠÇ—[]ŽÒ, ÌA f[][]fjk ffbfgf[]fN“à, ÌfRf“fsf...[]f^ ^, È^è^Ó, ÌfzfXfg ID  
, ðŠ,, è“- , Ä, é, K—v, ð, , è, Ü, ·, []B Internet , È, Ü^±, µ, Ä, ç, È, ç, fv  
%ofCfX[]fg, È flfbfgf[]fN, Á, íA“ÆŽ©, Ìfifbfgf[]fN Ž~ ·ÉŽq, ðŽg—p, ·, é, ±, Æ, à, Á, «, Ü, ·, ð, A Internet , È—  
L, Ç, È, flfbfgf[]fN ID , ð“üŽè, µ, Ä, ·, , Æ, A“«—^[]A fAfhfCEfX, ð, ðŠ,, è“- , Ä, ·, é, ±, Æ, È, []A fv  
%ofCfX[]fg, È flfbfgf[]fN, ð Internet , È, Ü^±, ·, é, ±, Æ, ð, Á, «, Ü, ·, []B

Internet fRf~f... fjjfefB, íA, ð, ·, Ü, È, fTfCfY, Ìfifbfgf[]fN, È“K[]±, ·, é, æ, x, È, A fAfhfCEfX fNf%ofX , ð^è< , µ, Ä, ç  
, Ü, ·, []B Šeflfbfgf[]fN fNf%ofX, íA AIP fAfhfCEfX, íA, ð%o, ÌfifNfefbfg, Å, Ç, ©, ð, ·, é, ±, Æ, ð, Á, «, Ü, ·, []B ŽŸ, Ì, ð  
, íA fAfhfCEfX, íA, ð%o, ÌfifNfefbfg, Æ, A fflfbfgf[]fN ID ftfB[]f<fh, ·, æ, Ñ, fzfXfg ID  
ftfB[]f<fh, ÌŠÖEW, ð, Ü, Æ, ß, ½, à, Ì, Á, ·, []B, ±, Ì, ·, í, A Internet fAfhfCEfX Žw^è·ùŽ®, È^®, µ, Ä, ç, é, ŠefAfhfCEfX fNf  
%ofX, Ìfifbfgf[]fN ID “[]”, ·, æ, Ñ, fzfXfg ID “[]”, àŽ!, µ, Ä, ç, Ü, ·, []B, ±, Ì, fTf“fvf<, Á, íA w.x.y.z , ðŽg, Á, Ä, AIP  
fAfhfCEfX, ÌfofCfG, ð, ·, µ, Ä, ç, Ü, ·, []B

fNf %ofX	w 'l*	flfbfgf[] fN ID	fzfXfg ID	flfbfgf[]fN []”	Šeflfbfgf[]f N, ÌfzfXfg[]”
A	1-126	w	x.y.z	126	16,777,214
B	128-191	w.x	y.z	16,384	65,534
C	192-223	w.x.y	z	2,097,151	254

\* IP fAfhfCEfX“à, Ì, ð%o, ÌfifNfefbfg, ÈŠÜ, Ü, è, é”í^í[]B fAfhfCEfX 127 , íA f[][]fjfk fRf“fsf...  
[]f^ ^ ä, Ìf<[]fvfobfN fefXfg, ·, æ, Ñ, fv[]fzXŠÖ^È[]M—p, È—\—ñ, ð, è, Ä, ç, é, Ì, Á, A fflfbfgf[]fN  
fAfhfCEfX, È, ÌŽg—p, Á, «, Ü, ð, ñ, B, Ü, ½, A 224 ^È[]ä, ÌfAfhfCEfX, íA“Á·É, È, fv[]fGfRf< (IGMP  
f}f<f“fLfffXfg, È, Ç) —p, È—\—ñ, ð, è, Ä, ·, è, A fzfXfg fAfhfCEfX, È, ÌŽg—p, Á, «, Ü, ð, ñ, B

flfbfgf[]fN fm[]fh, íA fflfbfgf[]fN ID , ·, æ, Ñ, fzfXfg ID , ðŽg, Á, Ä, A, Ç, ÌfPfPfbfg, ðŽó[]M, µ, Ä, Ç, ÌfPfPfbfg, ð-  
³Ž<, ·, x, «, ©, ð, Ç, È^è, µ, A“^—, Ì”í^í, ð, Ç, È^è, µ, Ü, ·, (“~ , ¶, Ìfifbfgf[]fN ID , ðŽ, Á, ½, fm[]fh, Ç, x, µ, ¾, ·, ð, AIP  
fCEfX<, Ìfuf[][]fhfLfffXfg, ð, Ç, È, Žó, ~“ü, è, é, ±, Æ, ð, Á, «, Ü, ·, []B

^—[]MŽÒ, Ì IP fAfhfCEfX, íA“[]M, ð, è, ÈŠe IP fPfPfbfg, ÈŠÜ, Ü, è, Ä, ç, é, Ì, Á, A Žó[]M, µ, ½, fR[]fh, í IP fAfhfCEfX  
ftfB[]f<fh, ©, ç, []M^x, Ìfifbfgf[]fN ID , ÆfzfXfg ID , ð, ø, []o, ·, ±, Æ, ð, Á, «, Ü, ·, []B, ±, è, È, Ì, A fTfufifbfg  
f}fXfN, ðŽg, í, è, Ü, ·, []B

**fTfuflfbfg f}fXfN**

fTfuflfbfg f}fXfN, í 32 frfbfg'l, Á, ·BIP fpfPfbfg, lžóMžÒ, íAfTfuflfbfg f}fXfN, đžg, Á, ÄAfzfXfg ID , ©, ç IP fAfhfCEfX, ìflfbfgf[]fN ID ·"·ª, ðæ·É, ·, é, ±, Æ,ª, Á, «, Ü, ·BIP fAfhfCEfX, Æ" —l, ÉAfTfuflfbfg f}fXfN, ì'l, àfhfbfg<æ[]Ø, è 10 []i·\<L, Á·\, ·, ì,ª^è"É"l, Á, ·BfTfuflfbfg f}fXfN, íAfifbfgf[]fN ID , É'®, ·, éfrfbfg, É 1 , ðAfzfXfg ID , É'®, ·, éfrfbfg, É 0 , đš,,, è"—, Ä, Ä[]-³, è, Ü, ·B'Sfrfbfg, É 1 , Ü, ½, í 0 , đ"K[]Ø, Éš,,, è"—, Ä, é, ÆA32 frfbfg'l, ìfhfbfg<æ[]Ø, è 10 []i·\<L, É·İš, ·³, è, Ü, ·BžŸ, ì·\, đžQ[]Æ, µ, Ä, ·¾, ·³, ç[]B

fAfhfCEfX	fTfuflfbfg f}fXfN, ìfrfbfg	fTfuflfbfg f}fXfN
fNf%ofX A	11111111 00000000 00000000 00000000	255.0.0.0
fNf%ofX B	11111111 11111111 00000000 00000000	255.255.0.0
fNf%ofX C	11111111 11111111 11111111 00000000	255.255.255.0

, ±, ìCE<%oÉ, É, æ, Á, Ä[]ATCP/IP, íAf[][]fjfk fRf"fsf...[]f^, ìfzfXfg ID , ·, æ, Ñflfbfgf[]fN ID , đ"»·É, µ, Ü, ·B, ½, Æ, ì, ìAIP fAfhfCEfX,ª 102.54.94.97 , ÄAfTfuflfbfg f}fXfN ,ª 255.255.0.0 , ì, Æ, «Afifbfgf[]fN ID , í 102.54AfzfXfg ID , í 94.97 , É, È, è, Ü, ·B

[]ä, ì·\, ðCE©, é, ÆAfzfXfg, ìfNf%ofX, ÍšÈ'P, ÉCE^è, Á, «, é, ì, ÁAfTfuflfbfg f}fXfN, ÁfzfXfg, ð[] []-, ·, é, ì, []ç'·, ÉCE©, ì, é, ©, à, µ, è, Ü, ñ[]B, µ, ©, µAfTfuflfbfg f}fXfN, íA·i[]", ìf[][]fjfk flfbfgf[]fN, Áš,,, è"—, Ä, ç, è, ½ 1 , Ä, ìflfbfgf[]fN ID , ð,³, ç, É<æª, ·, é, ½, ß, É, àžg, í, è, Ü, ·B

, ½, Æ, ì, ìA, , éflfbfgf[]fN, ÉfNf%ofX B , ìflfbfgf[]fN fAfhfCEfX 144.100 ,ªš,,, è"—, Ä, ç, è, Ä, ç, é, Æ %o¼'è, µ, Ü, ·B, ±, è, í 16,000 , ð'·, ì, éfNf%ofX B fAfhfCEfX, ì 1 , Ä, Á, , è[]A65,000 , ð'·, ì, éfm[]fh, ÉfT[]fRfX, ð'ñ<Ÿ, ·, é, ±, Æ,ª, Á, «, Ü, ·B, µ, ©, µA, ±, ì ID ,ªš,,, è"—, Ä, ç, è, Ä, ç, é[]çšE<K- Ì, Ìšè<Æflfbfgf[]fN, íA, »., è, ¼, è 75 , ©, ç 100 , ìfm[]fh, đžQ, Á, ½ 12 CEÁ, ì[]Ü LAN , ©, ç[]-, è—š, Á, Ä, ç , Ü, ·B, ±, ì, æ, x, È[]ê[]Afifbfgf[]fN ID , ð,³, ç, É 11 CEÁ'ç%oÁ, ·, é, æ, è, à[]Aš,,, è"—, Ä, ç, è, ½ ID , ì 144.100 , ðfTfuflfbfg, đžg, Á, ÄCEø—! "l, Éžg—p, µ, ½, Ü, x,ªCE<-¾, Á, ·BIP fAfhfCEfX, ì 3 "Ö-Ü, ìfifNfefbfg, ðfTfuflfbfg ID , Æ, µ, Äžg, çAfTfuflfbfg f}fXfN 255.255.255.0 , ð'è<` , ·, é, ±, Æ,ª, Á, «, Ü, ·B, ±, è, É, æ, è[]AfNf%ofX B fAfhfCEfX, íA144.100.0 , ©, ç 144.100.255 , Ü, Á, ì 256 , ìfTfuflfbfg, Éªš,,, Á, «, Ü, ·B, »., è, ¼, è, ìfTfuflfbfg, í 254 , ìfm[]fh, đžQ, Á, ±, Æ,ª, Á, «, Ü, · (fzfXfgID , ì, x, z[]A0 , Æ 255 , ðAfRf"fsf...[]f^, Éš,,, è"—, Ä, é, ± , Æ, í, Á, «, Ü, ñ[]B, ±, è, ç, ìAfuf[]fhfLfffXfg fAfhfCEfX, Æ, µ, Äžg, í, è, Ü, ·B'É[]A, ±, ìfAfhfCEfX, íA'SfRf"fsf... []f^,ª" Fž", µ, Ü, ·)[]B, ±, ì—á, Á, íA, ±, è, ç, ìflfbfgf[]fN fAfhfCEfX, ì, x, z, ì"C^Ó, ì 12 , ìfAfhfCEfX, ð, ±, ì[]Ü LAN , Éš,,, è"—, Ä, é, ±, Æ,ª, Á, «, Ü, ·BšE LAN "à, Á, íAšEfRf"fsf...[]f^, É, »., è, ¼, è ^è^Ó, ìfzfXfg ID , ðš,,, è"—, Ä, Ü, ·B, ±, è, ç, ìfzfXfg ID , ìfTfuflfbfg f}fXfN, í, ·, x, Ä 255.255.255.0 , Ä, ·B

[]ä, ì—á, ìAfNf%ofX B fAfhfCEfX, ÉšÖ, ·, éšÈ'P ( , ©, Á^è"É"l) , ÉfTfuflfbfg, ì·ùž®, đžì, ·, à, ì, Á, ·B[]è[]š, É, æ, Á, Ä, íAfTfuflfbfg ID , đžw'è, ·, é, ½, ß, É[] [] , ìfrfbfg,¾, ·, đžg, Á, ÄAfifNfefbfg, ì^è·,¾, ·, ðªš,,, µ, È, ·, è, Ì, È, ç, È, ç, ±, Æ, à, , è, Ü, · (fTfuflfbfg, ìfm[]fh[]",ª 256 , ð'·, ì, é[]è[]š, È, Ç)[]Bf+[]fU[] , íAf[][]fjfk flfbfgf[]fNšÇ—[]žÖ, Æ'S'k, µ, ÄAfifbfgf[]fN, ìfTfuflfbfg, ìCE '¥, ·, æ, Ñ[]³, µ, çfTfuflfbfg f}fXfN, ðCE^ , ß, Ä, ·¾, ·³, ç[]Bf[][]fjfk flfbfgf[]fN[]ä, ì'SfvXfef€, Áf[][]fjfk flfbfgf[]fN, ìflfbfgf[]fN ID , É'í, ·, éfTfuflfbfg f}fXfN, í"·, ¶, Á, È, ·, è, Ì, È, è, Ü, ñ[]B []d—v : ·"—[]flfbfgf[]fN[]ä, ìfRf"fsf...[]f^, Ì, ·, x, ÄA"·, ìfTfuflfbfg f}fXfN, Æflfbfgf[]fN ID , đžg, x·K—

v,ª, ,è,Û,·□B,±,ê,ç,ª^Ù,È,é,Æ□AfAfhfCEfXŽw'è, ",æ,Ñf<□[fefBf"fO,Å-â'è,ª□¶,¶,é%∞Â"\□«,ª, ,è,Û,  
·□B

**f<[]fefBf"fo,Æ IP fQ[]fgfEjFfC**

TCP/IP flfbfgf[]fN,Ç,µ,í[]AfQ[]fgfEjFfC (,Ü,½,í<[]f^[]),É,æ,Á,ÄÜ'±  
 ,³,è,Ü,·[]BQ[]fgfEjFfC,í[]AfCf" f^[]flfbfgf[]fN"à,ÄÜ'±,³,è,Ä,ç,éflfbfgf[]fN,ÉŠÖ,·,é[]î•ñ,ðŽ[],Á,Ä,ç  
 ,Ü,·[]B,»,è,¼,è,ì IP fzfXfg,í"Á"è,ì—[]M[]æ,Ö,ì[]Ä"í,Éf<[]fg (Ce~H) []î•ñ,ð•ÜŽ[],·,é,±,Æ,ª,Á,«,Ü,·,ª[]A  
 %"Šu,ì'—[]M[]æ,ðCE@,Á,¯,é,½,ß,É,í[]A"É[]ffffHf<fg fQ[]fgfEjFfC,ªŽg—p,³,è,Ü,· (ffffHf<fg fQ[]fgfEjFfC  
 ,í[]AfRf"fsf...[]f^,ªfCf" f^[]flfbfgf[]fN,ì"è" ,É,È,Á,Ä,ç,é[]è[]±,É,¾,¯•K—v,Á,·)[]B

IP ,í[]AfpfPfbfg,ì'—[]M,ð[]€"ð,·,é,Æ,«[]AfpfPfbfg,ìf[][]fj< ('—[]MCE³) IP fAfhfCEfX,Æ'—[]M[]æfAfhfCEfX,ðIP  
 fwfbf\_[][,É'}"ù,µ[]A'—[]M[]æ,ìflfbfgf[]fN ID ,ª'—[]MCE³,ìflfbfgf[]fN ID ,É"è"v,·,é,©,Ç,µ  
 ,©,ðCEÿ[],µ,Ü,·[]B—¼•ù,ìflfbfgf[]fN ID ,ª"è"v,·,é[]è[]±,í[]AfpfPfbfg,í[]Af[][]fj< flfbfgf[]fN[]ã,ì'—  
 []M[]æfRf"fsf...[]f^,É"¼[]Ü'—[]M,³,è,Ü,·[]B"è"v,µ,È,ç[]è[]±,í[]A"Ä"í<[]fg[]î•ñ,ª,È,ç,©f<[]fefBf"fo  
 fe[]fuf<,ª¹², x,ç,è,Ü,·[]BCE@,Á,©,ç,È,ç[]è[]±[]AfpfPfbfg,í[]A"z[]M,ì,½,ß,ÉffffHf<fg fQ[]fgfEjFfC,É"']'—  
 ,³,è,Ü,·[]B

ffffHf<fg fQ[]fgfEjFfC,í[]Af[][]fj< fTfufLfbfg,à,Ü,©,ìflfbfgf[]fN,ÉÜ'±,µ,Ä, ,éRf"fsf...  
 []f^,Á, ,è[]AfCf" f^[]flfbfgf[]fN"à,ì,Ü,©,ìflfbfgf[]fN,ìflfbfgf[]fN ID []î•ñ,ð[]Š—L,µ,Ä,¯,è[]A,±  
 ,é,ç,ìflfbfgf[]fN,Ö"ž'B,·,é•ù-@,à'm,Á,Ä,ç,Ü,·[]BffffHf<fg  
 fQ[]fgfEjFfC,í[]AfCf" f^[]flfbfgf[]fN"à,ì,Ü,©,ìflfbfgf[]fN,ìflfbfgf[]fN ID ,ð'm,Á,Ä,ç  
 ,é,ì,Ä[]AZw"è,³,è,½'—[]M[]æ,ÉÜ'±  
 ,·,éfQ[]fgfEjFfC,ÉžÄÜ,ÉfPfbfg,ª"z[]M,³,è,é,Ü,Ä[]A,Ü,©,ìfQ[]fgfEjFfC,É,±,ìfPfbfg,ð"']'—,·,é,±  
 ,Æ,ª,Á,«,Ü,·[]B,±,ìfv[]fZfX,ðf<[]fefBf"fo,ÆCEÄ,Ñ,Ü,·[]B

fQ[]fgfEjFfC,ðCe—R,µ,½fCf" f^[]flfbfgf[]fN f<[]fefBf"fo

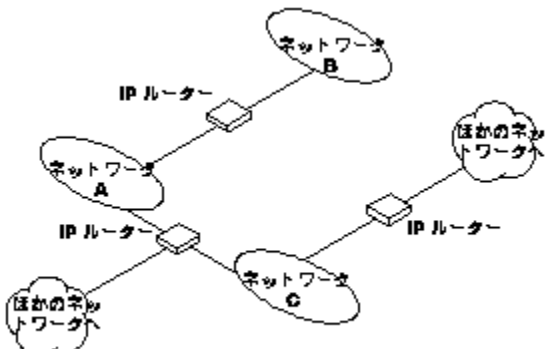

CEÄ[]X,ì IP fTfufLfbfg,ªfCf" f^[]flfbfgf[]fN,ÉÜ'±,³,è,Ä,ç,é[]è[]±[]AfLfbfgf[]fNŠÖ,Áf<[]fefBf"fo  
 (fPfbfg,ì"z[]M) ,ð[]s,µ,½,ß,É IP fQ[]fgfEjFfC,ªŽg,ì,è,Ü,·[]BTCP/IP fm[]fh,ª"Ü,È,éflfbfgf[]fN ID  
 ,ðŽ[],Áflfbfgf[]fN,Æ'É[]M,ð[]s,¯,µ,Æ,·,é[]è[]±[]AfQ[]fgfEjFfC (,Ü,½,ì"è"Ä,ìfQ[]fgfEjFfC) ,í[]A'—  
 []M[]æ,ìflfbfgf[]fN,ÉfPfbfg,ð"']'—,µ,È,¯,é,ì,È,è,Ü,¹,ñ[]BQ[]fgfEjFfC,í[]AfPfbfg,ª'—[]M[]æ,É".....,æ,µ  
 ,É[]A,»,ìfPfbfg,ì[]i,ª•ùCEü (žÿ,ìfQ[]fgfEjFfC,ìfAfhfCEfX) ,ðŽw"è,·,é<[]fefBf"fo fe[]fuf<,ð•ÜŽ[],µ,Ä,ç  
 ,Ü,·[]B

fCf" f^[]flfbfgf[]fN,ì"è" ,Á,ì,È,çflfbfgf[]fN,ì[]è[]±,í[]AIP fQ[]fgfEjFfC,ì•K—  
 v, ,è,Ü,¹,ñ[]Bflfbfgf[]fN,ªfCf" f^[]flfbfgf[]fN,ì"è" ,Á, ,è[]AfVfXfef€,ÉffffHf<fg  
 fQ[]fgfEjFfC,ªŽw"è,³,è,Ä,ç,È,ç[]è[]± (,Ü,½,ìfQ[]fgfEjFfC fRf"fsf...[]f^,ª³,µ, "[]@[]i,µ,Ä,ç,È,ç[]è[]±)  
 ,í[]Af[][]fj< fTfufLfbfg,ìŠÖ,Æ,ì"É[]M,¾,¯,É[]áŠQ,ª<N,±,è,Ü,·[]Bft[]fU[][,í[]Aroute  
 ft[]fefBfŠfefB,ðŽg,Á,Ä"í<[]fg,ð"']'C%ª,µ[]A"Á"è,ìfvfXfef€,ìf<[]fg,ðŽw"è,·,é,±  
 ,Æ,ª,Á,«,Ü,·[]B"Ä"í<[]fg,í[]A,Á,È,ÉffffHf<fg fQ[]fgfEjFfC,ìŽg—p,æ,è—D[]æ,³,è,Ü,·[]B

ffffHf<fg fQ[]fgfEjFfC,ª—~—p,Á,«,È,,È,È,Æ[]AfRf"fsf...[]f^,í[]AZ[]@•ª,ª'@,µ,Ä,ç,éTfufLfbfg,ìŠÖ'µ

,Æ'ÊM,Å,«,È,,È,è,Ü,·BfRf“fsf...[]f^,É•i” ,lffftfHf<fg fQ[]fgefEjFfC,đŠ,,,è“- ,Ä,Ä,“ , ,ÎA,±,ì,æ,κ,È-â'è,ì"-  
[]l,đ-h,®,±,Æ,ª,Å,«,Ü,·B•i” ,lffftfHf<fg fQ[]fgefEjFfC,đŽg—p,·,é,æ,κ,É[]\[]- ,³,è,Ä,ç,é,Æ[]AfVfXfef€  
,Í[]AfCf“f^[]fjfbfgf[]fN'ÊM<@“\,đŠm•Û,·,é,½,ß,É[]A[]\[]- ,³,è,Ä,ç,é,κ  
,¿,ì,Ü,©,ìf<[]f^[][,Æ'ÊM,đŽŽ,Ý,Ä[]Ä“`- ,ì-â'è,đ%°đCE^ ,μ,Ü,·B

Windows NT ,Å•i” ,lffftfHf<fg fQ[]fgefEjFfC,đ[]\[]- ,·,é,É,Í[]A[TCP/IP ,ì[]Ú[]×[]\[]-] f\_fcFaf[]fO  
f{fbfNfX,Å[]AŠefQ[]fgefEjFfC,²,Æ,É IP fAfhfCEfX,đŽw'è,·,é•K—v,ª, ,è,Ü,·B[]Ú[]×,É,Ä,ç,Ä,Í[]AMicrosoft  
TCP/IP ,Æ SNMP ,ì'g,Ý[]ž.Ý,Æ[]\[]- ,đŽQ[]Æ,μ,Ä,,³/4,³,ç[]B

**DHCP**

IP fAfhfCEfXŋ•ň,İŠ,,è“-Ä,Æ•ÜŽç,İ□AfCf“f^□[f]f]b]f]g]f]□□[f]N,İ□Ú'±,É□Ó“C,đ•%o,ŋf]f]b]f]g]f]□□[f]NŠÇ—  
 □ŽÖ,É,Æ,Ä,Ä•%o'S,É,È,è,Ü,·□B,±,İ•%o'S,İ^è^ö,İ□Aft□[f]U□[,İ'½,,İ□AZ©•ª,İfRf“fsf...  
 □[f^,đfCf“f^□[f]f]b]f]g]f]□□[f]N,ÄŽg—p,Ä,«.,é,æ,ŋ,É□ŋ—,·,é,½,ß,İ'mŽ^,ª,È,ç,İ,Ä□A]f]b]f]g]f]□□[f]NŠÇ—□ŽÖ,É□  
 □—□İ<Æ,đ—Š,ç,È,·,è,İ,È,ç,È,ç,±,Æ,É,·,è,Ü,·□B

DHCP (Dynamic Host Configuration Protocol; “@“İfzXf]g]□□—f]v]f]□]g]f]Rf<), İ□A,±,İŠÇ—□□İ<Æ,İ•  
 %o'S,đCEyCE,·,·,é,½,ß,ÉŠm—š,ª,è,Ü,µ,½□BDHCP, đŽg,ŋ,Æ□A^À'S□AŠmŽÄ,©,ÄŠÈ'P,É TCP/IP  
 f]f]b]f]g]f]□□[f]N,İ□ŋ—,đ□s,İ,Ü,·□B,Ü,½□AfAfhfCEfX,İ□d•j,đ-h,®,±,Æ,ª,Ä,«□AfAfhfCEfXŠ,,è“-Ä,đ□W'+ŠÇ—  
 □,µ,Ä IP fAfhfCEfX,İŽg—p□ó'Ö,đ^è^è,É•Ü,Ä,±,Æ,ª,Ä,«.,Ü,·□BDHCP, İ□AfRf“fsf...□[f^,İ IP  
 fAfhfCEfX,đ“@“İ,É□ŋ—,µ□A,ª,ç,ÉŠ,,è“-Ä,ç,è,½fAfhfCEfX,Éf]□[f]XŠúŠÖ,đ'İ%ož•t,·,Ü,·□B,Ü,½□ADHCP  
 ,İ□A^è•”,İfffB]f]Xf]N]CEfX f]Rf“fsf...□[f^,İfCf“f^□[f]f]b]f]g]f]□□[f]N□ŋ—,à'ň<Ÿ,µ,Ü,·□B

Windows NT, İ DHCP fNf%o]f]C]f]A]f“]f]g] f]T□[f]r]f]X,·,æ,Ŋ DHCP f]T□[f]o□[ f]T□[f]r]f]X,İŽÄ'•,İ□ARFC (Requests for  
 Comments) 1533□A1534□A1541□A,·,æ,Ŋ 1542,É□€<',µ,Ä,ç,Ü,·□B

DHCP, đŽg,Ä,½•ÜŽç□İ<Æ,ª,ç,©,ÉŠÈ'P,Ä,·,é,©□A—á,đŽİ,µ,Ü,µ,ä,ŋ□BDHCP fNf%o]f]C]f]A]f“]f]g] f]Rf“fsf...□[f^,İ  
 IP fAfhfCEfX,İ□A,»,İfRf“fsf...□[f^,ə]f]T]f]u]f]l]f]b]f]g],©,çŽæ,èŠÖ,ª,è,é,ÆŽ©“@“İ,É%ođ•ú,ª,è,Ü,·□B,±,İ DHCP fNf  
 %o]f]C]f]A]f“]f]g] f]Rf“fsf...□[f^,ª,Ü,©,İ]f]T]f]u]f]l]f]b]f]g],É□Ä□Ú'±,ª,è,é,Æ□A□V,µ,çfAfhfCEfX,ª,±  
 ,İ]f]T]f]u]f]l]f]b]f]g],ÉŽ©“@“İ,ÉŠ,,è“-Ä,ç,è,Ü,·□Bf]t□[f]U□[,à]f]l]b]f]g]f]□□[f]NŠÇ—□ŽÖ,à□A□V,µ,ç□  
 □—□İ•ň,đ'ň<Ÿ,·,é,½,ß,É]f]l]b]f]g]f]□□[f]N,É%oİ“ü,·,é•K—v,İ,·,è,Ü,ª,ň□B

ŽŸ,İ□}, İ□A2, Ä,İ]f]T]f]u]f]l]f]b]f]g],É□ŋ—□İ•ň,đ'ň<Ÿ,µ,Ä,ç,é DHCP f]T□[f]o□[,İ—á,Ä,·□BfNf%o]f]C]f]A]f“]f]g] C, đ]f]T]f]u]f]l]f]b]f]g] 1  
 ,É^Ú“@,·,é,Æ□ADHCP f]T□[f]o□[,İ□AfNf%o]f]C]f]A]f“]f]g] C, əŽŸ%oň<N“@,·,é,Æ,«.,É□A□V,µ,ç TCP/IP □  
 □—□İ•ň,đŽ©“@“İ,É'ň<Ÿ,µ,Ü,·□B

f<□[f]efB]f“f]OŽw'è,ª,è,½f]f]b]f]g]f]□□[f]Nä,İ DHCP fNf%o]f]C]f]A]f“]f]g],Æ DHCP f]T□[f]o□[

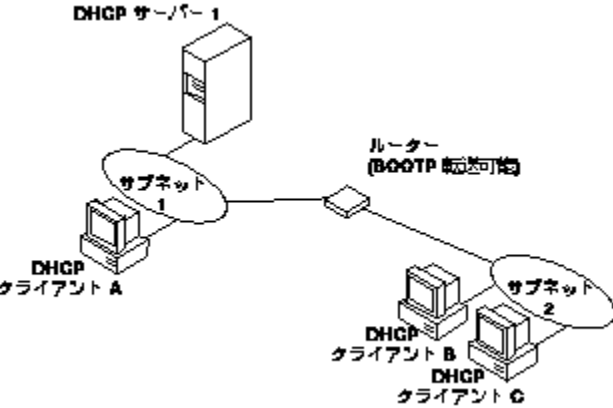

DHCP, İ□AfNf%o]f]C]f]A]f“]f]g] f]T□[f]o□[ f,fff<,đŽg,Ä,Ä,ç,Ü,·□BDHCP fNf%o]f]C]f]A]f“]f]g] f]Rf“fsf...  
 □[f^,İ□AfV]f]X]f]e]f]€<N“@Žž (□%oŠú%o»□ó'Ö), É□Af]v]f]□[f]g],ÉfCf“f^□[f]f]b]f]g]f]□□[f]Nä,İ,·,x,Ä,İ DHCP  
 f]T□[f]o□[,É'+Cp,ª,è,é%oÄ“ŋ<,İ,·,é□A“CE□f]□]f]b]f]Z□[f]W (discovery message),ÆCEÄ,İ,è,é]f]□□[f]f]f<  
 f]f]b]f]g]f]□□[f]N,Ö,İ]f]u]f]□□[f]h]f]l]f]f]X]f]g],đ'—□M,µ,Ü,·□B“CE□f]□]f]b]f]Z□[f]W,đŽÖ,~Žæ,é]f]v]f]□[f]g]  
 f]C]f“f^□[f]f]b]f]g]□ä,İŠe DHCP f]T□[f]o□[,İ□A—v<,đ'—,Ä,½fNf%o]f]C]f]A]f“]f]g],İ,½,ß,İ IP fAfhfCEfX,Æ—LCEø,É□  
 □—□İ•ň,đŠÜ,ň,¾'ň<Ÿ]f]□]f]b]f]Z□[f]W (offer message), đ%ož“š,µ,Ü,·□B

DHCP fNf%o]f]C]f]A]f“]f]g],İ□A]f]T□[f]o□[,©,ç'ň<Ÿ,ª,è,é□ŋ—,đ□W,ß□A'İ'đ□ó'Ö,É“ü,è,Ü,·□B,±,İ]f]Nf%o]f]C]f]A]f“]f]g],ª—  
 v<□□ó'Ö,É,È,é,Æ□A□ŋ—,İ,ŋ,ç,İ 1,Ä,đ'İ'đ,µ□A,»,İ'İ'đ,µ,½□ŋ—,É'İ%ož,·,é DHCP f]T□[f]o□[,đŽ^•È,·,é,½,ß,É—  
 v<□]f]□]f]b]f]Z□[f]W (request message), đ'—□M,µ,Ü,·□B]f]š]f]W]f]f<,İ“CE□f]□]f]b]f]Z□[f]W,đŽÖ,~Žæ,Ä,½,»,è,¼,è,İ





## Windows flfbfgf[]fN,ì-¼'O%øCE^

Windows NT ,ð TCP/IP ,ðŽg—p, ,é,æ,æ,É[]\—, ,é,É,í[]Afrf“fsf...[]f^—¼,Æ IP fAfhfCEfX,æ•K—v,Ä,·[]B,± ,é,ç,í[]A,» ,ìfrf“fsf...[]f^ ,ðflfbfgf[]fNä,Ä^ê^Ö,ÉŽ^•É,µ,Ü,·[]B,±,ì[]í,Ä,·,Ä,É[]à—¼,µ,½,æ,æ,É[]Afrf“fsf... []f^ ,ì IP fAfhfCEfX,í[]A^ê^Ö,ìfAfhfCEfX,Ä, ,è[]Afcf“f^[]flfbfgf[]fNä,ì,·,x,Ä,ì TCP/IP fffofCfX,í[]A,± ,ìfAfhfCEfX,É,æ,Ä,Ä,» ,ìfrf“fsf...[]f^ ,ð“FŽ^ ,µ,Ü,·[]BTCP/IP , ,æ,Ñ Internet ,Ä,ìfrf“fsf...[]f^—¼,í[]A—¼'O,É DNS fhf[]Cf“—¼,ð•t%øÄ,µ,½,à,ì,Ä,· (f[][]ffk flfbfgf[]fNä,Ä,ìfrf“fsf...[]f^—¼,í[]Afrf“fsf...[]f^ ,É•t, ,½ %oi^±“ì,É—¼'O,Ä,·)[]B

frf“fsf...[]f^ ,í[]AIP fAfhfCEfX,ðŽg,Ä,ÄCEÝ,ç,ð“FŽ^ ,µ,Ü,· ,æ[]Aft[]fU[] ,É,Æ,Ä,Ä,í[]Afrf“fsf... []f^ ,ðŽg,Ä,Ä,í[]A,è,ð[]s,æ,Ü,æ,æŠÈ^P,Ä,·[]B,±,ì,½,ß TCP/IP flfbfgf[]fN,Ä,í[]Afrf“fsf...[]f^—¼,ð IP fAfhfCEfX,É•ìŠ,·,é (%øCE^ , ,é) <@[]\,æ•K—v,Æ,É,è,Ü,·[]Bfrf“fsf...[]f^—¼,Æ IP fAfhfCEfX,ì^ê^Ö<«,ð•Ü[]Ø,·,é,½,ß,É[]ATCP/IP ,ðŽg,æ Windows NT frf“fsf...[]f^ ,í[]A<N“@Žž,É,è,» ,ìfrf“fsf... []f^—¼,Æ IP fAfhfCEfX,ðflfbfgf[]fN,É“o^~ ,µ,Ü,·[]BWindows NT frf“fsf...[]f^ ,í[]ATCP/IP fCf“f^[]flfbfgf[]fN“à,Ä,³Sm,É—¼'O,ì%øCE^ ,ð[]s,æ,½,ß,É[]AZÝ,ì 1 ,Ä,Ü,½,ì•j[] ,ì•ùŽ@ ,ðŽg,æ,± ,Æ,æ,Ä,« ,Ü,·[]B

### WINS ,Æfuf[]fhfLfffXfg—¼'O%øCE^

IP fAfhfCEfX,ðfrf“fsf...[]f^—¼,Öf}fbfsf“fO, ,é @“lff[]f^fx[]fX,ðŽg,Ä[]A1 ,Ä,Ü,½,ì, ,é,è^è[]ä,ì WINS ft[]fo[] ,æ~—p,Ä,« ,é,èè[]±,É,í[]AWindows NT frf“fsf...[]f^ ,ì WINS (Windows Internet Name Service; Windows fCf“f^[]flfbfgf[]fN,É“o^~ ,µ,Ü,·[]BWINS ,í[]A,Ü,©,ì—¼'O %øCE^ •ùŽ@ ,æ“K[]Ø,Ä,ì,É,çfCf“f^[]flfbfgf[]fN,Ä[]Afu[]fhfLfffXfg—¼'O%øCE^ ,Æ'g,Ý[]±,ì,¹,ÄŽg— p,Ä,« ,Ü,·[]BWINS ,í[]ARFC (Requests for Comments) 1001/1002 ,É p fm[]fh,Æ,µ,Ä'è< ,³,è,Ä,ç,é[]ATCP/IP []ä,ì NetBIOS (NBT) ,ì“@[]f,[]fh,ì 1 ,Ä,Ä,·[]B

Windows NT frf“fsf...[]f^ ,í[]ARFC 1001/1002 ,É b fm[]fh fv[]fgfRf<,Æ,µ,Ä'è< ,³,è,Ä,ç ,éfu[]fhfLfffXfg— ¼'O%øCE^ ,ðŽg,æ,±,Æ,à,Ä,« ,Ü,·[]B,±,ì•ùŽ@ ,í[]AIP fCEfXf< ,ìfu[]fhfLfffXfg,ð[]— ,µ[]Afrf“fsf...[]f^— ¼,ðflfbfgf[]fNä,ÄfAfifEf“fX,µ,Ä“o^~ ,·,éfrf“fsf...[]f^ ,ÉÈ'¶,µ,Ä,ç,Ü,·[]Bfu[]fhfLfffXfg— Ìæ“à,ìŠefRf“fsf...[]f^ ,í[]A•j[]—¼,ð“o^~ ,µ,æ,æ,Æ,·,éŽž,Ý,Æ[]A“o^~—¼,É'ì,·,é—¼'O[]Æ%oi,Ö,ì %øž“š,É[]Ó“C,ðŽg,ç,ì,Ü,·[]B

### fhf[]Cf“ f[]f€ fvXfef€,ìfAfhfCEfXžw'è

DNS (Domain Name System; fhf[]Cf“ f[]f€ fvXfef€) ,í[]ATCP/IP []ä,ì NetBIOS ,à[]AFTP ,É,Ç,ì Windows Sockets fAfvfŠfP[]fVf#f“ ,ðŽg,Ä,Ä[]Afrf“fsf...[]f^ ,ð“ÜžifzfXfg,É[]U'±,·,éèè[]±,É[]A— ¼'O,ìf}fbfsf“fO,ð'², x, éžè'ì,ð'ñ<Ý,µ,Ü,·[]BDNS ,í[]A1980 “N“ä[]%Šú,É Internet ,æ<}CEf,ÉŠg'â,µ,½,Æ,«”- []¶,µ,½fgf%oftfBfbfNä,ì—à'è,ð%øCE^ , ,é,½,ß,É[]YEv,³,è,½•æŽUff[]f^fx[]fX,Ä,·[]B

### fzfXfg ftf@fCf<,ðŽg,Ä,½—¼'O%øCE^

LMHOSTS ftf@fCf<,í[]ANetBIOS frf“fsf...[]f^—¼,Æ IP fAfhfCEfX,Æ,ìf}fbfsf“fO,ðŽw'è,·,é,½,ß[]A,Ü,½ HOSTS ftf@fCf<,í[]ADNS —¼,Æ IP fAfhfCEfX,Æ,ìf}fbfsf“fO,ðŽw'è,·,é,½,ß[]A[]ffk frf“fsf... []f^ ,Ä'ñ<Ý,·,é,±,Æ,æ,Ä,« ,Ü,·[]B

í%øž,·,éfrf“fsf...[]f^—¼,Éf}fbfsf“fO,³,è,½Šù'm,ì IP fAfhfCEfX,ð^ê— ,·,é,½,ß,É[]AHOSTS ftf@fCf< (Windows Sockets fAfvfŠfP[]fVf#f“ ,Ä TCP/IP fzfXfg—¼,ìCEÝ[]ð,ÉŽg—p) ,Æ LMHOSTS (TCP/IP []ä,ì NetBIOS ,Ä Microsoft flfbfgf[]fN frf“fsf...[]f^—¼,ìCEÝ[]ð,ÉŽg—p) ,ðŽg,æ,±,Æ,æ,Ä,« ,Ü,·[]BLMHOSTS ,í[]A[]—<K— Ìflfbfgf[]fN WINS ,æ~—p,Ä,« ,É,çfŠf,[]fg fTufifbfg,Ä,ì Windows NT ,ì—¼'O%øCE^ ,ÉŽg,ì,è,Ä,ç,Ü,·[]B

ŠÖ~A[]€—Ü

### TCP/IP []ä,ì NetBIOS ,É,Ä,ç,Ä



## B fm[fh

b fm[fh f,[fh,Å,íA-¼'O,ì"o~^,,"æ,Ñ%øδCE^,Éfuf[fhflfffXfg,ðŽg,ç,Ü,·B,½,Æ,í,îANT\_PC1 ,ª NT\_PC2  
,Æ'ÊM,μ,½,çêê#ANT\_PC1 ,íAŽ©•ª,ª NT\_PC2 ,ð'T,μ,Ä,ç  
,é,ÆA'Sf}fVf",É'í,μ,Äfuf[fhflfffXfg,μANT\_PC2 ,ª%ž"š,·,é,Ü,Å^è'èŽžŠÔ'Ò<@,μ,Ü,·Bb  
fm[fh,É,íAŽŸ,ì,æ,α,È 2 ,Å,ì'â,«,È-â'è,ª ,è,Ü,·B



'â<K-í,Èflfbfgf[fNŠÂ<<,Å,íAfuf[fhflfffXfg,É,æ,éflfbfgf[fN•%ø%øx,ª'â,«,È,è,Ü,·B



f<[f^[[,ífuf[fhflfffXfg,ð"']—,μ,Ü,¹,ñB,μ,½,ª,Å,ÄAf<[f^[[,ìCEü,±,α'α,É ,éfRf"fsf...[f^,É,íA  
—v<[,í"í,«,Ü,¹,ñB



## M fm[]fh

m fm[]fh f,[]fh,í[]A"-[]%[]Ab fm[]fh,Æ p fm[]fh,ÉŠÖ~A,·,é-â'è,ð%øðCE^,·,é,½,ß,É[]ì[]-,³,ê,Ü,μ,½[]Bm  
fm[]fhŠÂ<<,Å,Í[]AfRf"f sf...[]f^,í[]A,Ü, ,[]Ab fm[]fh,ðŽg,Á,Ä"o~^,Æ%øðCE^,ðŽŽ,Ý,Ü,·[]B,±,ê,É[]-CE÷,μ,È,ç  
,Æ[]Ap fm[]fh,É[]Ø,è'Ö,í,Á,Ä[]Ä,ÑŽŽ,Ý,Ü,·[]Bm fm[]fh,í[]A[]%,ß,É b fm[]fh,ðŽg,æ  
,ì,Å[]Af[]fbfgf[]fN[]ä,Å,ìfuf[]fhfLfffXfg fgf%øftfBfbfN[]f[]-,ì-â'è,í%øðCE^,μ,Ü,¹,ñ[]B,μ,©,μ[]A,±  
,ìf,[]fh,ìf<[]f^[][,ð%øz,ì,é,±,Æ,³,Ä,«,Ü,·[]B,Ü,½[]A•K, ,[]Ä[]%,É b fm[]fh,³ŽŽ,³,é,é,ì,Å[]AWINS  
fT[]fo[][,³f\_fEf",μ,½[]ê[]±,Å,à[]Af<[]f^[][,Æ"- ,¶'±,ìfRf"f sf...[]f^,í'É[]í,ç, ,è"@[]ì,μ'±, ,Ü,·[]B  
fuf[]fhfLfffXfg,É,æ,é[]fbfgf[]fN•%ø%øx,Æ,ç,æ-â'è,³-ç%øðCE^,Å, ,é,½,ß[]Am fm[]fh,í[]A, ,Ü,èŽg,í,ê,é,±  
,Æ,í, ,è,Ü,¹,ñ[]B,Ü,½[]AWindows NT flfbfgf[]fN ,Å,í m fm[]fh,í[]Af<[]f efBf"fO,³,é,½ŠÂ<<,ì NetLogon ,Å-  
â'è,ð<N,±,·%øÄ"[]«,à, ,è,Ü,·[]B

## H fm[]fh

h fm[]fh f,[]fh,à[]Ab fm[]fh,Æ p fm[]fh,Æ,ì'g,Ý[]#,í,¹,Å,·,²[]Ah fm[]fh  
f,[]fh,Å,í[]Afuf[]fhfLfffXfg,í[]ÅCEã,ìŽè'i,Æ,µ,ÅŽg,í,è,Ü,·[]B,±,ìf,[]fh,í[]ACE»[]Ý[]ARFC ,ìfhf  
%oftfg'iŠK,Å,·[]B[]Å%º,É p fm[]fh,²-p,ç,ç,è,é,ì,Å[]AWINS fT[]fo[][,²ŽÀ[]s't,Å, ,è[]AfRf"fsf...  
[]f^,²f<[]f^[][,É,Ü,½,²,é,±,Æ,²,Å,«,è,í[]Afuf[]fhfLfffXfg,í[]¶[]-,³,è,Ü,¹,ñ[]BWINS  
fT[]fo[][,²fEf",µ,½[]è[]#,í[]Ab fm[]fh,²-p,ç,ç,è,é,ì,Å[]Af<[]f^[][,Æ"- ,¶'²,ìfRf"fsf...  
[]f^,í'É[]í,ç,¨,è"®[],µ'±,¨,Ü,·[]B-¼'O,ì"o~^,É[]A,±,ìŽÀ'·,í m fm[]fh,ðŽg,ç,Ü,· (fuf[]fhfLfffXfg[]AŽŸ,É-  
¼'O,ì[]Æ%ºi)[]B

h fm[]fh f,[]fh,í[]Ab fm[]fh,Æ p fm[]fh,ìŽg—p[]#[]~,ð·í[]X,·,é,¾,¨,Å,í, ,è,Ü,¹,ñ[]BWINS  
fT[]fo[][,²fEf",µ,Äf[]fj< fuf[]fhfLfffXfg (b fm[]fh) ,ðŽg,²·K—v,², ,é[]è[]#[]AfRf"fsf...[]f^,í WINS  
fT[]fo[][,Ö,ì-à,ç[]#,í,¹,ð'±[]s,µ,Ü,·[]BWINS fT[]fo[][,Ö,ìfAfNfZfX,²º°Å"\\,É,È,é,Æ[]A'¼,¿,ÉfVfXfef€,í p  
fm[]fh,É-ß,è,Ü,·[]BfìfVfVfj" ,Æ,µ,Ä[]Ab fm[]fh,Ö·æCE³,·,é'O,É[]ALMHOSTS ftf@fCf<,ðŽg,²,æ,²,É h  
fm[]fh,ð[]\[]-,·,é,±,Æ,à,Å,«,Ü,·[]B

h fm[]fh f,[]fh,í[]Afuf[]fhfLfffXfg,¨,æ,Ñf<[]fefBf"fOŠÅ<«,Å,ì"®[],ÉŠÖ~A,·,é[]Å,à[]d—v,È-â'è,ð  
%ºðCE^,µ,Ü,·[]BTCP/IP ,ðŽè"®,Å[]\[]-,·,é Microsoft TCP/IP ft[]fU[][,É,Æ,Á,Ä,í[]Ah  
fm[]fh,²ffftfHf<fg,Å,·[]B,½,¾,µ[]ATCP/IP ,ð[]\[]-,·,é,Æ,«[]AWINS fT[]fo[][,ì IP  
fAfhfCEfX,ð'ñ<Ÿ,·,é,ÆffftfHf<fg,Å,í,È,,È,è,Ü,·[]B

**B fm[]fh ,Æ LMHOSTS[]A, ",æ,Ñ,»,ì'g,Ÿ[]†,í,¹**

Microsoft flfbfgf[][]fN,Å,í[]AWINS ft[]fo[][,Æ p\_fm[]fh,ìŽÀ'•,È,µ,Å[]Af<[]f^[][,ð%oz,!,é,Û,©,ì b\_fm[]fh,àŽg,í,ê,Ä,ç,Û,·[]B[]C³,³,ê,½ b\_fm[]fh,í[]ALMHOSTS ftf@fCf<,ÉŠi"[,³,ê,Ä,ç,éfRf"fsf... []f^,ÆfAfhf[]fX,ì^ê—,ðŽg,ç,Û,·[]Bb\_fm[]fh,ìŽŽ[]s,²Ž,"s,·,é,Æ[]AfVfXfef€,í LMHOSTS "à,ÅfRf"fsf... []f^-¼,ð'T,µ[]A,»,é,ÉŠÖ~A•t,\_,ç,ê,½fAfhf[]fX,ðŽg,Á,Äf<[]f^[][,ð%oz,!,Û,·[]B,µ,©,µ[]AŠefRf"fsf...[]f^,É,±,ì^ê—,ðŠi"[,µ,Ä,°,•K—v,ª, ,é,ì,Å[]A^ê—,ì•ÜŽç,Æ"z•z,Æ,ç,²ŠÇ—[]ä,ì•%oS,ª"[]µ,Û,·[]BWindows NT ,Ä,í[]A,±,ìftf@fCf<,ÉŠg'£<@"\,ª,ç,,Ä,©•t%oÁ,³,ê,Ä,ç,Ä[]AŠÇ—[]ª,µ,â,,È,Ä,Ä,ç,Û,·,ª[]A[]C³,³,ê,½ b\_fm[]fh,í—[]z"l,È%oðCE^•û-@,Å,í, ,è,Û,¹,ñ[]B

b\_fm[]fh,ìŽÀ'•,Æ p\_fm[]fh,ìŽÀ'•,ì-¼•û,ð"~Žž,ÉŽg,²•K—v,ª, ,éfTfCfg,à'[]Y,·,é,©,à,µ,ê,Û,¹,ñ[]B,½,¾,µ[]A,±,ì[]\[]-,í" @[]'‰Ä"\,Ä,·,ª[]AŠÇ—[]Žò,í'½'â,È'[]^ó,ð•¥,²•K—v,ª, ,è,Û,·[]B,±,ì•û-@,í[]A%oß"n"l,È[]ó<µ,Ä,¾,~Žg—p,µ,Û,·[]Bp\_fm[]fh fzfxfg,ífuf[][]fhfLfffXfg,ð-³Ž<,µ[]Ab\_fm[]fh fzfxfg,ífuf[][]fhfLfffXfg,É^É'[]µ,Ä-¼'O%oðCE^,ð[]s,ç,Û,·[]B,µ,½,ª,Ä,Ä[]A2 ,Ä,ífzfxfg,í"~,[]NetBIOS -¼,Å[]\[]-,³,ê,é%oÄ"\[]ª,ª, ,è[]A,»,ì,½,ß,É—\Šú,Å,«,È,çCE<%oÉ,ð[]µ,%oÄ"\[]ª,ª, ,è,Û,·[]B



**WINS ,Æfuf□□[fhfLfffXfg-¼'O%øðĈ^**

WINS ,í□Af□□[fefBf"fo,³,è,½f|fbfgf□□[fNŠÅ««,É,¨,ç,Ä□AfRf"fsf...□[f^-¼,©,ç IP  
fAfhfĈfX,Ö,ì"@"lf}fbfsf"fo,ð"o~^,¨,æ,Ñ□Æ  
%øï,·,é,½,ß,ì•²ZUff□[f^fx□[fX,ð'ñ<ÿ,μ,Û,·□Bf□[fefBf"fo,³,è,½f|fbfgf□□[fN,ðŠÇ—□,·,é□ê□‡,í□A-¼'O  
%øðĈ^,É,í□Å□%ø,É WINS ,ðĈĈ"ç,·,é,ì,²□Å—Ç,ì'í'ð,Å,·□B,»è,í□AWINS ,²□A•í ŽG,ĚfCf"ƒ^□[f|fbfgf□□[fN,ì-  
¼'O%øðĈ^,Å"□¶,·,é-à'è,ð%øðĈ^,·,é,æ,æ,É□YĈv,³,è,Ä,ç,é,©,ç,Å,·□B

WINS ,ðŽg,æ,Æ□A-¼'O%øðĈ^,ì,½,ß,ìf□□[fjƒ< fuf□□[fhfLfffXfg,ìŽg—p•p"x,²Ĉ,□,μ□AfŠf,□[fg  
f|fbfgf□□[fN□ä,ÅŠĚ'P,ĚfvfXfefĚ,ð'T,·,±,Æ,²,Å,«,Û,·□B,³,ç,É□ADHCP  
,ðŽg,Å,½"@"lfAfhfĈfXŽw'è,É,æ,Å,Ä□AfTfuf|fbfgfŠÖ,ð^Ú"@"·,·,éRf"fsf...□[f^,É□V<K IP  
fAfhfĈfX,²□□-³,è,é,Æ□AWINS ff□[f^fx□[fX,²Ž"@"@"I,É□X□V,³,è,Û,·□B,±  
,ì□ê□‡□Af□[fU□[.àf|fbfgf□□[fNŠÇ—□ŽÖ,à□A-¼'O%øðĈ^,ðŽè"@"Å²□@,·,é•K—v,í, ,è,Û,¹,ñ□B

WINS fv□fgfRf<,í□ARFC 1001 ,¨,æ,Ñ 1002 "à,ì NBNS ,É'è<³,è,½fv□fgfRf<,ÉŠî,Å,ç  
,Ä,¨,è□A,Û,½,»è,ç,ÆĈĈŸŸ·□«,², ,è,Û,·□B,μ,½,²,Å,Ä□ARFC ,ì,Û,©,ìŽÀ'•,Æ'ŠĈĈŸ%ø^—p,²%øÅ"\\,Å,·□B

**,»è,ì'¼,ì'□^ÓŽ-□€**



Windows NT ^ĚŠÖ,ìRf"fsf...□[f^,ÄŽÀ□s,³,è,é PDC ,², ,é□ê□‡,í□AWINS  
ff□[f^fx□[fX,É□Å"lfGf"fgfŠ,ð□,ç,È,¨,é,î,È,è,Û,¹,ñ□B"ü—ì,·,é-¼'O,í□A16 fofCfG-Ú,² 1B ,ìfhf□fCf"-  
¼,Å,È,¨,é,î,È,è,Û,¹,ñ□B,Û,½□AfAfhfĈfX,í PDC ,ì IP fAfhfĈfX,Å,È,¨,é,î,È,è,Û,¹,ñ□B,½,Æ,ì,í□APDC  
,ìfhf□fCf",² ABC ,Å□AfAfhfĈfX 11.11.12.1 ,ìRf"fsf...□[f^,Å PDC ,²ŽÀ□s,³,è,Ä,ç  
,é,Æ,μ,Û,·□B,»è,ì□ê□‡□A□Å"í□%øŠú%ø» (,½,Æ,ì,í Imhosts) ftf@fCf<,ÉŽŸ,ì,æ,æ  
,ĚfGf"fgfŠ,ðŽw'è,μ□AWINSADMN **11.11.12.1 "ABC \0x1B"**  
,ðŽg,Å,Ä,»è,ìftf@fCf<,ðfCf"ƒ□[fg,μ,È,¨,é,î,È,è,Û,¹,ñ□B

'□ : ABC ,í□A16 fofCfG-Ú,Û,Å<ó"•¶Žš,Å-,·,ß,ç,è,Ä,ç,Û,·□B16 fofCfG-Ú,í□A16 □i,ì'1 1B ,Å,·□B  
□Å"í□%øŠú%ø»ftf@fCf<,É,»è,ì PDC ,²fhf□fCf",ìf□[f"fo□[,Æ,μ,ÄŽì,³,è,Ä,ç,è,î□A□ä<L,ì□i<Æ,ð□s,æ•K—  
v,í, ,è,Û,¹,ñ□B,½,¾,μ□A,»è,±,É 1B fgf"fgfŠ,ð"ü,è,é,Æ□AfoftfH□[f]ƒ"ƒX,²Ĉü□ä,μ,Û,· (fnf  
%øfCfAf"fg,í□APDC ,ð,æ,è"□,ĈĈ©,Å,¨,é,±,Æ,²,Å,«,Û,·)□B

fTftfBfbfNfX,Æf□[fX,É,æ,é-¼'O

- <f}fVf" -¼><0> -- fŠf\_fCfĈfNf^/f}fVf" -¼
- <f}fVf" -¼><03> -- f□fbfZf"ƒWff fT□[fƒX-¼
- <f}fVf" -¼><20> -- LANMAN fT□[fo□[-¼
- <fhf□fCf" -¼><1B> -- fhf□fCf" f}fXf^ fuf%øfEfU-¼
- <fhf□fCf" -¼><1C> -- DC ,ðŠÛ,ƒfCf"ƒ^□[f|fbfg fOf<□[fv-¼
- <fhf□fCf" -¼><1D> -- f}fXf^ fuf%øfEfU-¼
- <fhf□fCf" -¼><1E> -- fOf<□[fv f}fXf^ fuf%øfEfU"í□o-¼
- <ft□[fU□[-¼><03> -- f□fbfZf"ƒWff fT□[fƒX,Å"o~^

ŽŸ,ì□€-Ú,Å,í□AWINS ,Æ-¼'O□Æ%øifuf□□[fhfLfffXfg,²□AWindows f|fbfgf□□[fN,Å-¼'O%øðĈ^,ð□s,æ•û-  
@,ìŠT—v,ð□à-¾,μ,Û,·□B

-  [f□\[fefBf"fo,³,è,½ŠÅ««,Å,ì WINS](#)
-  [WINS ,Æfuf□□\[fhfLfffXfg,É,æ,é-¼'O%øðĈ^](#)
-  [WINS -¼'O"o~^](#)



WINS -¼'O%øđ•ú



WINS -¼'O□',«Š.:!



RAS ,ì IP fAfhfĀfXŽw'è

ŠÖ~A□€-Ú

WINS fT□[fo□L,ì'g,Ý□ž,Ý,Æ□\□=

## Windows NT WINS

WINS は、ネットワーク上のコンピュータに IP アドレスと NetBIOS 名を関連付けるためのデータベースです。WINS サーバは、クライアントからの問い合わせに対して、データベースを検索し、適切な NetBIOS 名を返します。

Windows NT WINS は、Windows NT 4.0 の WINS サービスです。WINS は、RFC 1001 (NetBIOS over TCP/IP) と RFC 1002 (NetBIOS over IP) を実装しています。WINS は、ネットワーク上のコンピュータに IP アドレスと NetBIOS 名を関連付けるためのデータベースです。

WINS は、ネットワーク上のコンピュータに IP アドレスと NetBIOS 名を関連付けるためのデータベースです。WINS は、ネットワーク上のコンピュータに IP アドレスと NetBIOS 名を関連付けるためのデータベースです。WINS は、ネットワーク上のコンピュータに IP アドレスと NetBIOS 名を関連付けるためのデータベースです。

WINS は、ネットワーク上のコンピュータに IP アドレスと NetBIOS 名を関連付けるためのデータベースです。

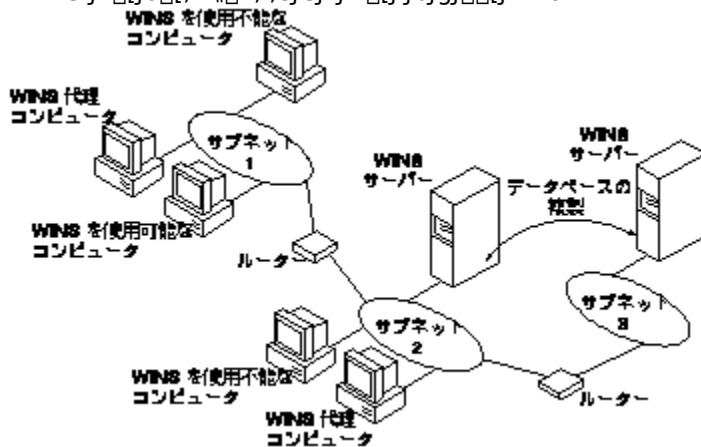

WINS は、ネットワーク上のコンピュータに IP アドレスと NetBIOS 名を関連付けるためのデータベースです。WINS は、ネットワーク上のコンピュータに IP アドレスと NetBIOS 名を関連付けるためのデータベースです。WINS は、ネットワーク上のコンピュータに IP アドレスと NetBIOS 名を関連付けるためのデータベースです。

WINS は、ネットワーク上のコンピュータに IP アドレスと NetBIOS 名を関連付けるためのデータベースです。

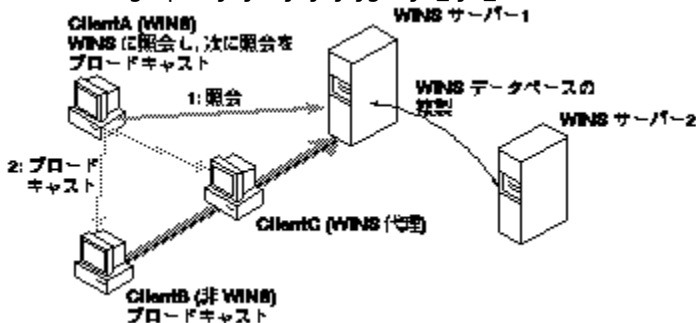

ã,ì},Á,íAClientA ,íA,Ü, , WINS fT[fo[É-â,ç±,í,¹,Ä-¼'O,ð%ðCE^,µ,æ,æ,Æ,µ,Ü,·B,±  
,è,ÉŽ,"s,·,é,ÆAfuf[fhfLfffXfg-¼'OÆ%ö,ðŽg,ç,Ü,·BClientB ,íAWINS ,ð-~—p,Á,«,È,ç,ì,ÁA-¼'O  
%ðCE^,É,Ífuf[fhfLfffXfg-¼'OÆ%ö,µ,©Žg,ì,Ü,¹,ñB,µ,©,µAClientC  
,íAfuf[fhfLfffXfg,ðŽó,~Žæ,é,ÆA—v<,ð WINS fT[fo[É"]'—,µA-¼'O,ð ClientB ,É•Ö,µ,Ü,·B

Windows NT fRf"fsf...[f^,ª DHCP ,ð-~—p,Á,«,éRf"fsf...[f^,Á, ,èAŞÇ—ŽÖ,ª DHCP flfvfvfþf",Æ,µ,Ä  
WINS ,ð-p^Ó,µ,Ä,ç,éê±,íA,±,ìRf"fsf...[f^,íAWINS fT[fo[í•ñ,ÁŽ©"®"l,É\→,³,è,Ü,·BDHCP  
,ðŽg,í,È,çRf"fsf...[f^,ª WINS -¼'O%ðCE^,ð-~—p,Á,«,é,æ,æ,É,·,é,É,íA[TCP/IP ,ì\→] f\_CfAfO  
f{fbfNfX,ÁAWINS fT[fo[,ì IP fAfhfçfX,ðŽw'è,µ,Ü,·B'ä—fT[fo[,ðŽw'è,·,é,É,íA[TCP/IP ,ìÚ×\→]  
f\_CfAfO f{fbfNfX,ìA[WINS 'ä—fG[fWfFfg,ð—LCEø,É,·,é] f`ffbfN f{fbfNfX,ðflf",É,µ,Ü,·B

**WINS ,Æfuf□□[fhfLfffXfg,É,æ,é-¼'O%øðCE^**

flfbfgf□□[fN□ä,Å□Aft□[fU□□ (,Ü,½,lfvf□fZfX) ,æŠf,□[fg fRf"fsf...□[f^ ,Æ,ì□Ú'±,ð—v□□,·,é,Æ□A-¼'O□Æ%øï—  
 v□□,æ□□,ü,ü,·□B,½,Æ,ì,ì□Afrf}f"fh fvf□f"fvfg,Å net use x: \\treycorp\sources ,Æ"ü—  
 Í,·,é,Æ□Areycorp ,Æ,ç,æ-¼'O,lfRf"fsf...□[f^ ,É'í,·,é-¼'O□Æ%øï—  
 v□□,lfpfPfbfg,æfuf□□[fhfLfffXfg,³,è,Ü,·□BTPC/IP ,í IP fAfhfCEfX,ð"FŽ~ ,µ,Ü,·,æ□AWindows flfbfgf□□[fN  
 fT□[frfX,í-¼'O,µ,© Žg—p,µ,È,ç,ì,Å□Afcf" f^□[flfbfgf□□[fN□ä,lfRf"fsf...□[f^ ,í□A'É□M,µ,½,çfRf"fsf...□[f^ ,ì-  
 ¼'O,ð%øðCE^ ,µ,Å IP fAfhfCEfXŽw'è,É•ÍŠ·,µ,È,·,è,í,È,è,Ü,¹,ñ□B

WINS fT□[fo□[ ,æfCf" f^□[flfbfgf□□[fN□ä,É"z'u,³,è,Ä,ç,é,Æ,«□A-¼'O,ì%øðCE^ ,É,í,» ,è,¼,è,lfRf"fsf...□[f^ ,Å  
 WINS ,É,æ,é%øðCE^ ,ðŽg—p%øÄ" (—LCEø) ,É□Y'è,µ,Ä,ç,é,©,É,æ,è□A2 ,Ä,ÍŠî—{ "I,É•ûŽ® ,æŽg,í,è,Ü,·□B

**WINS ,æŽg—p•s%øÄ" ,Éèè†** fRf"fsf...□[f^ ,í□A-¼'O"o~^—v□□pfPfbfg,ð UDP ff□[f^fOf%øf€CEo—  
 R,Åf□□[fj< fTfufLfbfg,Éfuf□□[fhfLfffXfg,µ,Ä□A,» ,ì-¼'O,ð"o~^ ,µ,Ü,·□B"ñ WINS fRf"fsf...□[f^ ,í□A□□[fj<  
 fTfufLfbfg,É-¼'O□Æ%øï—v□□,ðfuf□□[fhfLfffXfg,µ,Ä'Á'è,lfRf"fsf...□[f^ ,ðCE© ,Ä,·,Ü,·,æ□A,±  
 ,lfuf□□[fhfLfffXfg,í•□" ,ì IP f□□[f^□[ ,É,Ü,½,æ,Ä"n,³,è,é,±,Æ,í, ,è,Ü,¹,ñ□B□□[fj<-¼'O  
 %øðCE^ ,ÉŽ , "s,·,é,Æ□A□□[fj< LMHOSTS ftf@fcfç,æ²,x,ç,è,Ü,·□B,±,è,ç,lfvf□fZfX,í□Afrf"fsf...  
 □[f^ ,æflfbfgf□□[fN fT□[fo□[ ,©f□□[fNfXfe□[fVf†" ,Ä ,Ä,Ä,à□A,Ü,½,í•É,lfffofCfX,Ä ,Ä,Ä,à"~ ,ü,Å,·□B

**WINS ,æŽg—p%øÄ" ,Éèè†** fRf"fsf...□[f^ ,í□A,Ü,· WINS fT□[fo□[ ,É-à,ç□†,í,¹□A,±,è,æ□—CE±,µ,È,ç  
 ,Æ□A-¼'O"o~^—v□□ ,æ,ñ-¼'O□Æ%øï—v□□,ð□AUDP ff□[f^fOf%øf€ ,Åfuf□□[fhfLfffXfg,µ,Ü,·□B  
 '□ : ,ç,ì,æ,æ,É-¼'O%øðCE^ •û-@ ,æŽg,í,è,Ä,à□AfvfXfef€,æ□□—,³,è,½CEä,í□A,±  
 ,lfvf□fZfX,lf†□[fU□[ ,É,Æ,Ä,Ä"š%øß"l,Ä,·□B

fRf"fsf...□[f^ ,æ WINS ,ð—~—p,Ä,« ,éèè†□A-¼'O%øðCE^ ,íŽÿ,ìŽèè†,Å□s,í,è,Ü,·□B

1. TCP/IP ,ì□□—Žž,É□Afrf"fsf...□[f^ -¼,í WINS fT□[fo□[ ,É"o~^ ,³,è□AWINS  
 fT□[fo□[ ,ðfcf" f^□[flfbfgf□□[fN□ä,ÅCE© ,Ä,·,é,±,Æ,æ,Ä,« ,é,æ,æ,É WINS fT□[fo□[ ,ì IP  
 fAfhfCEfX,æf□□[fj< ,ÉŠi"l,³,è,Ü,·□BWINS ff□[f^fx□[fX,í□Afcf" f^□[flfbfgf□□[fN□ä,ì'S WINS  
 fT□[fo□[ ,Ä•□" ,³,è,Ü,·□B

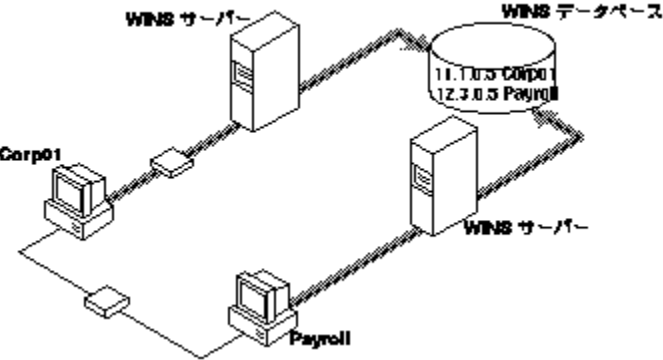

2. -¼'O□Æ%øï—v□□,æ□A,Ü,· WINS fT□[fo□[ ,É'—□M,³,è,Ü,·□B,±,ì—v□□,É,í□AIP  
 f□□[f^□[ ,ð'É,ü,Äf□□[fefBf"fo,³,è,½fŠf,□[fg fNf%øfCfA f"fg,©,ç,ì—v□□,æŠÜ,Ü,è,Ä,ç,Ü,·□B,±,ì—  
 v□□,í□AUDP ff□[f^fOf%øf€,Ä,·□BWINS ff□[f^fx□[fX,Ä-¼'O,æCE© ,Ä,·,Ä,½èè†□Afvf  
 %øfCfA f"fg,í□AWINS ,©,çŽó,~ Žæ,Ä,½fAfhfCEfX f}fbfsf"fo,ÉŠi,Ä,ç,ÄfZfbfVf†" ,ðŠm—s,Ä,« ,ü,·□B

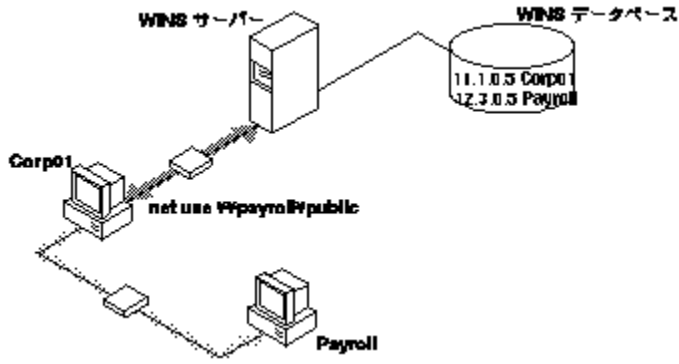

3. WINS fT[f^,Ö,ìAE%ö,â-CE÷,μ,È,©,Á,½êê#AfvXfef€,íAWINS ,ðŽg—p,Á,«,È,çfRf“fsf...  
 [f^,AE“~,¶•û-@,ÁA-¼'OAE%öi—v<[fPfbfg,ðfuf[ffhLfffXfg,μ,Û,· (fuf[ffhLfffXfg,É,æ,é  
 %öðCE^,â,»,ìfVfXfef€,ÁŽg—p%öÁ“\,Èêê#)B

WINS fT[f^,íAUDP -¼'OAE%öi,AE TPC -¼'OAE%öi,ðŽó,~“ü,êA,±,è,É%öž“š,μ,Û,·BWINS  
 fT[f^,ðŽg,Á,Ä“o~^,³,è,½-¼'O,©,ç IP fAfhfCEfX,Ö,ìf}fbfsf“fo,Á, ,è,î,Ç,è,Á,àA-¼'OAE%öi,Ö,ì  
 %öž“š,AE,μ,ÄM—Š,μ,ÄŽg—p,·,é,±  
 ,AE,â,Á,«,Û,·B,½,¾,μAfff[f^fx[fX“à,ìf}fbfsf“fo,íAŠÖ~AfffofCfX,âCE»ÝŽÀ[s't,Á, ,é,±  
 ,AE,ð•ÛØ,·,é,à,ì,Á,í, ,è,Û,¹,ñBfRf“fsf...[f^,â,»,ì IP fAfhfCEfX,ð—v<[μ,½,±,AE,AEA,»,è,âCE»Ý—  
 LCEø,Èf}fbfsf“fo,Á, ,é,±,AE,ð•ÛØ,μ,Ä,ç,é,É,·,Û,¹,ñB,Û,©,ì Windows flfbfgf[fN  
 fT[f^,â,»,ìfRf“fsf...[f^,âŽÀÛ,É“®ì,μ,Ä,ç,é,©,Ç,æ,©A, ,é,ç,í,»,ìfRf“fsf...[f^,â“Á'è,ìfLfbfgf[fN  
 fm[ffh,É, ,é,©,Ç,æ,©,ð²,x,Û,·B

Windows flfbfgf[fN,Á WINS fT[f^,âRf“fsf...[f^-¼,ð%öðCE^,Á,«,È,çêê#Afuf[ffhLfffXfg,É,æ,é-  
 ¼'O%öðCE^,â[s,í,è,Û,·B,»,ìêê#AÁ%ö,Éf[ff<fRf“fsf...[f^-¼fLfffbfVf...,â²,x,ç,èAŽÿ,Éf[ff<  
 fuf[ffhLfffXfg,â[s,í,è (,±,ìêê#Af<[f^,ð'É,¶,Ä“]—,³,è,Û,¹,ñ)AÁCEä,Éf[ff< LMHOSTS  
 ftf@fc<,É,æ,Á,Ä-¼'O,â%öðCE^,³,è,Û,· (#INCLUDE fXfe[fgf“fg,ÁŽQAE,³,è,éW† LMHOSTS  
 ftf@fc<,â,·,x,ÄEÿð,³,è,Û,·)B

**WINS -¼'O“o~^**

-¼'O“o~^,ð—~—p,·,é,Æ□Afrf“fsf...□[f^~¼,Æ IP fAfhfCfX,İšefffofCfX,É'İ,μ,ÄŠmŽÄ,É^ê^Ó,É,È,è,Ü,·□B

**WINS ,äŽg—p%oÄ”\,È□ê□‡:**

<£□‡,ä,È,·,ê,İ□A-¼'O“o~^—v<□,İ□AWINS fT□[fo□[,É'¼Ü'—□M,³,ê,Äff□[f^fx□[fX,É'Ç%oÄ,³,ê,Ü,·□BWINS  
,İ□Afff□[f^fx□[fX,İCE»□Ý,İ“à—e,É%ož,¶,Ä□Afrf“fsf...□[f^~¼,İ“o~^,ðŽó,·•t,·,é,©<'“Ü,·,é,©,μ,Ü,·□B,±  
,İff□[f^fx□[fX,É□A,±,İfrf“fsf...□[f^~¼,İ,Ü,©,İfAfhfCfX,ä“ü,Ä,Ä,ç,é□ê□‡□AWINS  
,İCE»□Ý,İfGf“fgfŠ,ðŽŽ,μ,Ä□A,» ,ê,ðŽİ,·fffofCfX,ä□A,Ü,¼,» ,İ-¼'O,ð•K—v,Æ,μ,Ä,ç,é,Ç,π  
,©,ð”»'è,μ,Ü,·□B,Ü,©,İfffofCfX,ä,±,İ-¼'O,ðŽg—p,μ,Ä,ç,é□ê□‡□AWINS ,İ□V<K,İ-¼'O“o~^—  
v<□,ð<'“Ü,μ,Ü,·□B,±,İ-¼'O,ðŽg—p,μ,Ä,ç,éfffofCfX,ä“¶□Ý,μ,È,·,ê,İ□AWINS  
,İ□Afgf“fgfŠ,ðŽó,·“ü,ê,Ä□A^fcfXf^f“fv,â“□•ä,μ,½^ê^Ófo□[fWf†f““Ô□†,È,Ç,İ□î•ñ,Æ,ç,Á,μ,â,Éf□□[ff<  
ff□[f^fx□[fX,É'Ç%oÄ,μ,Ü,·□B

**WINS ,äŽg—p•s%oÄ”\,È□ê□‡:**

“ñ WINS frf“fsf...□[f^,İ□A,» ,İ-¼'O,ð“o~^,·,é,½,ß,É□ANetBIOS -¼'O“o~^—v<□fPfpfbfg,ðf□□[ff<  
flfbfgf□□[fN,Éfuf□□[fhflfffXfg,μ,Ü,·□B,±,İ—v<□,É,İ□Afrf“fsf...□[f^~¼,Æ IP fAfhfCfX,ä“ü,Ä,Ä,ç,Ü,·□B,» ,İ  
NetBIOS -¼,ð,·,Ä,É—v<□,μ,Ä,ç,éflfbfgf□□[fNä,İfffofCfX,ä ,ê,İ□A,Ç,é,Ä,à□A-¼'O“o~^,İ“Ü'è%ož“š,ðŽg—  
p,μ,Ä-¼'O“o~^,ðŽŽ,Ý,é,İ,Ä□ACE<%oÉ,Æ,μ,ÄfGf%o□[,É,È,è,Ü,·□BŽw'èŠúŠÔ“à,É“o~^—  
v<□,ä□s,İ,é,È,·,ê,İ□Afrf“fsf...□[f^,İ,±,İ-¼'O,ÆfAfhfCfX,ð□İ—p,μ,Ü,·□B

“ñ WINS frf“fsf...□[f^,İ□A,ç,Ä,½,ñ-¼'O,ð—v<□,μ,½CEä,İ□A-¼'O“o~^,İŽŽ□s,ð•İ□»,·,é•K—  
v,ä ,è,Ü,·□B,Ü,½□A,» ,İ“o~^~¼,É'İ,μ,Ä”□s,³,ê,½-¼'O□Æ%oİ,É,İ□A-¼'O□Æ%oİ,İ□m'è%ož“š,ð'—  
□M,μ,Ä□m'è“İ,É%ož“š,·,é•K—v,ä ,è,Ü,·□B,±,İ%ož“š,É,İ□Afrf“fsf...□[f^,İ IP fAfhfCfX,ä“ü,Ä,Ä,·,è□A,±,é,Ä  
2 ,Ä,İfVfXfef€.İfZfbfVf†f“,ðŠm—š,Ä,« ,é,æ,π,É,È,è,Ü,·□B

**WINS -¼'O%ø•ú**

fRf"fsf...[f^,á"Á'è,ì-¼'O,Á□|—¹,·,é,Æ (Server fT□[frfX,á'âŽ~ ,μ,½,æ,π,È□ê□‡)□A,» ,ì-¼'O,É'í,μ,Ä,» ,ê^È□ä,Ü,©,ì"o~^—v<□,²ŽŽ,Ý,ç,ê,é,±,Æ,í,·,è,Ü,¹,ñ□B,±,è,ð□A-¼'O,ì%ø•ú,ÆCEÄ,Ñ,Ü,·□B

**WINS ,²Žg—p%øÄ" \, È□ê□‡:**

fRf"fsf...[f^,í□A□³□í,ÉfVfffbfjgf\_fEf",·,é,Æ□A•K,· WINS fT□[fo□[É-¼'O,ð%ø•ú,μ,Ü,·□B,±,é,É,æ,Á,Ä□AŠÖ~A,·,éff□[f^fx□[fX fGf"fgfŠ,í%ø•ú (released) ,Æ,μ,Äf}□[fN,³,è,Ü,·□BfGf"fgfŠ,á^è'èŠúŠÖ %ø•ú,³,è,½,Ü,Ü,É,É,Ä,Ä,ç,é,Æ□AWINS fT□[fo□[í,» ,è,²"pŠü (extinct) ,³,è,½,à,ì,Æ,μ,Äf}□[fN,μ□A,» ,ìff□[f^fx□[fX,ì•ï□X,² WINS fT□[fo□[ŠÖ,Ä"~'B,³,è,é,æ,π ,É□Afo□[fWfjgf"~"Ö□†,ð□X□V,μ,Ü,·□B"pŠüfGf"fgfŠ,í□A•ï□X,á'S WINS fT□[fo□[ÉŠmŽÄ,É"~'B,³,è,é,æ,π ,É,·,é,½,ß□AZw'è,³,è,½ŠúŠÖ,¾,~ff□[f^fx□[fX,ÉŽc,è,Ü,·□B

WINS fT□[fo□[Á-¼'O,²%ø•ú,³,è,½,à,ì,Æ,μ,Äf}□[fN,³,è□A,±,ì%ø•ú,³,è,½-¼'O,ðŽg—p,μ,Ä,ç ,é,²fAfhfCEfX,á^Ü,É,è□V<K,ì"o~^,²"í,,Æ□AWINS fT□[fo□[É,í□A<CEfNf%øfCfAf"fg,²,» ,ì-¼'O,ðŽg—p,μ,Ä,ç ,É,ç,±,Æ,²,²,©,Á,Ä,ç,é,ì,Á□A,±,ì-¼'O,ð'¼,ç,É—v<□CE³fNf%øfCfAf"fg,É—^ ,ì,Ü,· (,±,é,í□A,½,Æ,ì,î DHCP ,ð—~—p,Ä,« ,é%øbfvfgfbfv fRf"fsf...[f^,²fTfufjfbfg,ð•ï□X,μ,½□ê□‡,È,Ç,É<N,±,è,Ü,·)□B,» ,ìfRf"fsf... □[f^,²□A□³□í,ÉfVfffbfjgf\_fEf",Á-¼'O,ð%ø•ú,μ,½□ê□‡□AWINS fT□[fo□[í,±,ì-¼'O,ðŽŽ,μ,Ü,¹,ñ□BfVfXfefeŠ fŠfZfbfg,²CE'ö,ÁfRf"fsf...□[f^,²□Ä<N"® ,μ,½□ê□‡,É□A□V<KfAfhfCEfX,Á-¼'O"o~^ ,ð□s,π,Æ□AWINS fT□[fo□[í"o~^ ,ðŽŽ,μ,Ü,·□B,μ,©,μ□A,±,ìfRf"fsf...□[f^,ì,·,Ä,É<CEfAfhfCEfX,ðŽ ,Á,Ä,ç,é,ì,Á□A,± ,ìŽŽ□s,ìŽ ,~s,μ□A"o~^ ,ì□—CE±,μ,Ü,·□B

**WINS ,²—~—p%øÄ" \, Ä, È, ç□ê□‡:**

"ñ WINS fRf"fsf...[f^,²-¼'O,ð%ø•ú,·,é,Æ□Afuf□□[fhfLfffXfg,²□ì□—,³,è,Ä□A,» ,ì-¼'O,ðfLfffbfVf...,μ,Ä,ç,é %øÄ" \□« ,²,· ,éflfbfgf□□[fN□ä,ì"C^Ó,ìfVfXfefe,í,» ,ì-¼'O,ð□í□œ,μ,Ü,·□BfRf"fsf...□[f^,í□A□í□œ,³,è,½-¼'O,ðŽw'è,·,é-¼'O□Æ%øifpfPfbfg,ðŽó,~Žæ,é,Æ□A'P,É,» ,ì—v<□,ð-³Ž<,μ□Afjfbfgf□□[fN□ä,ì,Ü,©,ìfRf"fsf... □[f^,²%ø•ú,³,è,½-¼'O,ðŽæ"¾,·,é,±,Æ,ð<-%øÄ,μ,Ü,·□B

"ñ WINS fRf"fsf...□[f^,²,Ü,©,ìfTfufjfbfg,©,çfAfNfZfX%øÄ" \,Æ,È,é,½,ß,É,í□A"ñ WINS fRf"fsf...□[f^,ì-¼'O,ð WINS ff□[f^fx□[fX,Ü,½,ìfŠf,□[fg fVfXfefe,ì LMHOSTS ftf@fCf<,É□Ä"l,É'Ç%øÄ,·,é•K—v,²,·,è,Ü,·□B,± ,é,í□A"ñ WINS fRf"fsf...□[f^,²Ž©•²,ìf□□[fj< fTfufjfbfg,²"□MCE³,Ä ,é-¼'O□Æ%øí,É,μ,©%øž"š,μ,È,ç ,½,ß,Ä,·□B



**WINS -¼'O' ,«Š·,!**

□',«Š·,!(renewal) ,Æ,Í□AŽw'è,³,è,½ŽžŠú,ÉfRf"fsf...□[f^-¼,ð WINS fT□[fo□[ ,É□Ä"o~^ ,; ,é,± ,Æ,Á,·□BŠefGf"fgfŠ,Íf^fCf€fXf^f"fv,Í□A,» ,ÍfGf"fgfŠ,Ì—LCEøŠúCEÀ,ð·\,μ,Û,·□BfGf"fgfŠ,³f□□[fj]f< WINS fT□[fo□[ ,É,æ,Á,Ä□Š—L,³,è,Ä,ç,é□ê□‡,Í□AfNf%ofCfAf"fg,³□Ä"o~^ ,ð□s,Á,Ä,ç,È,ç,©,¬,è□A-¼'O,ÍŽw'è,³,è,½ŽžŠú,É%øð·ú,³,è,Û,·□B□Ä"l,Æ'è< ,³,è,½fGf"fgfŠ,Í□AŠúCEÀ□Ø,è,É,È,é,±,Æ,Í, ,è,Û,¹,ñ□BfGf"fgfŠ,³·É,ì WINS fT□[fo□[ ,É,æ,Á,Ä□Š—L,³,è,Ä,ç,é□ê□‡,Í□AŽw'è,³,è,½ŽžŠú,ÉfGf"fgfŠ,Ì—LCEø□« ,ÍŠm" F,³□s,í,è,Û,·□B,» ,ÍfGf"fgfŠ,ð□Š—L,μ,Ä,ç,é WINS fT□[fo□[ ,Íff□[f^fx□[fX,É'¶□Ý,μ,È,ç□ê□‡,Í□AfGf"fgfŠ,Íf□□[fj]f< WINS ff□[f^fx□[fX,©,ç□i□œ,³,è,Û,·□B-¼'O,ì□',«Š·,!—v<□,Í□A□V<K-¼'O"o~^ ,Æ"¬,¶,æ,α,É□^—□,³,è,Û,·□B

□',«Š·,!,Í□AWINS fT□[fo□[ ,Á-¼'O,ð'èŠú"l,É□Ä"o~^ ,; ,é,±,Æ,É,æ,è□A"o~^ ,É□M—Š□« ,ð—^ ,; ,Ä,ç,Û,·□BWINS ff□[f^fx□[fX"à ,ÍfGf"fgfŠ,É'í,· ,éfffHf<fg,ì□',«Š·,!ŠÔŠu,Í□A4 "ú,Á,·□BWINS fNf%ofCfAf"fg,Í□A2 "ú,²,Æ,É"o~^ ,Æ□X□V,ð□s,ç,Û,·□B,±,ì□Ý'è,É,æ,è□AfIbfGf□□[fN fgf%oftfBfbfN,³CEyCE ,³,è□AWINS ,³·É'O,æ,è'½,,Ífm□[fh,ð^μ,; ,é,æ,α,É,È,è,Û,·□Bfvf%ofCf}fŠ WINS fT□[fo□[ ,ÆfofbfNfAfbfv WINS fT□[fo□[ ,ì□',«Š·,!ŠÔŠu,Í"¬,¶,Á,È,¬,è,ì,È,è,Û,¹,ñ□B

**RAS ,ì IP fAfhfCEfXŽw'è**

RAS (Remote Access Service; fŠf, [fg fAfNfZfX fT [frfX) ,íA  
%o“Šu'É<ŽÒA^Ú“@<AEŽÒA, ,æ,Ñ•i” ,lftfBfX,ĀfT [fo [ ,iŠĂŽ<,âŠÇ—, ðs,xfVfXfef€ŠÇ—  
ŽÒ,É AfŠf, [fg flfbfgf [fN<@“\,đ'ň<Ÿ,μ,Û,·BWindows NT fRf“fsf... [f^ [ã,ì RAS  
ft [fU [ ,í AfŠf, [fg, ©, cf\_fCf, ,f<fCf“ ,μ,Ā flfbfgf [fN,É fAfNfZfX,μ AfTf@fCf<,âfvfŠf“f^ ,ì<æ—  
L A“dŽqf [f< AfXfPfwf... [fŠf“fo A, ,æ,Ñ SQL ff [f^ f× [fX,Ö, l fAfNfZfX,È,Ç, l fT [frfX,đŽó, ,é,±  
,Æ,³,Ā,« ,Û,·B

Windows NT RAS ,í ARAS fT [fo [ ,ì IP f< [fefBf“fo ,Æ,Æ,à,É<@“\,μ,Ā ARAS fNf%ofCfAf“fg,³ TCP/IP  
flfbfgf [fN,đŽg—p,Ā,« ,é,æ,æ,É,μ,Û,·BWindows NT ,Ā,í A<ÆŠE•W [€ ,ì PPP (Point to Point Protocol; fl  
fCf“fg fC [ flfCf“fg fvf [fgfRf<) , ,æ,ÑSLIP (Serial Line IP; fVfŠfAf< f%ofCf“ IP) <KŠi,àŽg—p,³,è,Ā,ç,Û,·B,±  
,è,ç,ì<KŠi,đŽg,æ,Æ AWindows NT ,ÆfT [fh fp [fefB> ,lŠf, [fg fAfNfZfX fT [fo [ ,Û,½, lŠf, [fg fAfNfZfX  
fNf%ofCfAf“fg flftfgfEJfA,Æ,ì ŠCEY%o^—p,³%oĀ“\,É,È,è,Û,·BRAS fNf%ofCfAf“fg,í A-¼' O  
%oðCE^ fT [frfX,É DNS ,Æ WINS ,đŽg—p,Ā,« ,Û,·B

Windows NT ,Ā RAS ,đŽg,Ā,½ flfbfgf [fN fAfNfZfX

RAS fT [fo [ ,í ARAS fT [fo [ 'g,Ýž,ÝŽž,É AŠ,,,è—,Ā,ç,è,½ IP fAfhfCEfX, lfv [f<,đ'ň<Ÿ,μ,Û,·BPPP ,đŽg,æ  
RAS fNf%ofCfAf“fg,af\_fCf, ,f<fCf“ ,·,é,Æ AIP fAfhfCEfX, aŽ © “@“l,ÉŠ,,,è—,Ā,ç,è,Û,·B flfbfgf [fNŠÇ—  
ŽÒ,³ AfAfhfCEfX,í Ā“ lfv [f<,đŽg,æ,æ,É RAS fT [fo [ ,ðŸ'è,μ,Ā,ç,é [é [ĀŠe RAS  
fT [fo [ ,É,í Ā•Ē, l flfbfgf [fN fAfhfCEfX, àŠ,,,è—,Ā,ç,è,Û,·B Ā'è,ì RAS fT [fo [ ,Éf\_fCf, ,f<fCf“ ,·,é' SfNf  
%ofCfAf“fg,É,í A“ , flfbfgf [fN ID ,Æ Ā•Ē, l fzfXfg ID ,³Š,,,è—,Ā,ç,è,Û,·B

RAS fNf%ofCfAf“fg, í A“ , flAfhfCEfX<óŠÔ,đ<æ—L,μ A~ \_—“l,ÉCE< [μ,Ā,ç,é (•—“l,É,í•a—£,μ,Ā,ç  
,é) A•i“ ,ì TCP/IP flfbfgf [fN,É Ÿ'± ,·,é,±,Æ,³,Ā,« ,Û,·B •i“ Ÿ'± ,ðs,æ,Æ,« ,à ARAS fNf  
%ofCfAf“fg,í ADNS , ,æ,Ñ WINS ,đ-¼' O%oðCE^ ,É“ , fl,æ,æ,ÉŽg—p,Ā,« ,Û,·B

RAS ,ì Ÿ×,É,Ā,ç,Ā,í A wMicrosoft Windows NT Server fŠf, [fg fAfNfZfX fT [frfX×,đŽQ [Æ,μ,Ā,-  
,¾,³,ç [B

**fhfjfcf" fl[f€ fvfxjfe€,lfafhfcejxžw'è**

DNS (Domain Name System; fhfjfcf" fl[f€ fvfxjfe€) ,Æ,íAInternet ã,lfzxfjg,ðž`•É,·,é,½,ß,ÉAŠK'w-¼'O•t,`fvfxjfe€,ð`ñ<ÿ,·,é•ažUff[f^fx[fX,ì,±,Æ,Å,·BDNS ,íA1980 "N'ã%Šú,ÉAInternet ã,lfzxfjg",`< }Cef,É'□%Á,μ,½,Æ,«<N,±,Á,½-â`è,ð%ðCE^,·,é,½,ß,ÉŠJ",`³,è,Ü,μ,½BDNS ,ìŽd—l,íARFC 1034 ,`æ,Ñ 1035 ,É`è<`³,è,Ä,ç,Ü,·B

DNS fff[f^fx[fX,íAfhfjfcf" fl[f€ fvfxjfe€ÆÄ,î,è,éfcfš[□'ç,É,È,Ä,Ä,ç ,Ü,·BŠefm[fh,Ü,½,lfhfjfcf" ,É,í-¼'O,`a•t,`ç,è,Ä,`",èAftfufhfjfcf" ,ðŠÜ,ß,é,±,Æ,`a,Ä,«,Ü,·Bfhfjfcf" -¼,©,çAefhfjfcf" ,É'í,·,é,» ,lfhfjfcf" ,lff[f^fx[fX"à,Ä,î^É'u,`a,í,©,è,Ü,·Bfhfjfcf" -¼,íADNS fhfjfcf" ,ìŠeflfbfgf[fN fm[fh,ì-¼'O,ðfsfšfih,Åæ∅,Á,Žw'è,μ,Ü,·B

DNS fff[f^fx[fX,lf<[fg,íAInternet flfbfgf[fN fcf"ftfhfjfcf" fzf" f^□[ ,`aŠÇ— □,μ,Ü,·Bfgfbjvfjfcfj<,lfhfjfcf" ,íA'g□D•É,`",æ,Ñ□•É,ŠŠ,,`è"- ,Ä,ç,è,Ä,ç,Ü,·B,±,è,ç,lfhfjfcf" -¼,íA□'□Ü<Kš ISO 3166 ,É€<,μ,Ä,ç,Ü,·B□'¼,í 2 •¶Žš,ìÉ—`aCE` ,Ä•\,μA'g□D-¼,É,ìŽÿ,ì,æ,æ,ÈŠeŽí,ìÉ —`aCE` ,`a—p^Ó,`³,è,Ä,ç,Ü,·B

<u>DNS fhfjfcf"-¼,ìÉ—`aCE`</u>	<u>'g□D,ìŽí—p</u>
com	%oc—`c'ì (,½,Æ,ì,íAMicrosoft.com)
edu	<³ç<@ŠÖ (,½,Æ,ì,íAAMIT,É,í mit.edu)
gov	□•{<@ŠÖ (,½,Æ,ì,íA'S•Ä %oŠšw□à'c,É,í nsf.gov)
org	"ñ%oc—`c'ì (,½,Æ,ì,íAFidoNet ,É,í fidonet.org)
net	flfbfgf[fN'g□D (,½,Æ,ì,íANSFNET ,É,í nsf.net)

Še DNS fhfjfcf" ,íA•É□X,ì'g□D,`aŠÇ—□,μ,Ä,ç ,Ü,·B`ÉíAŠe'g□D,íA,» ,lfhfjfcf" ,ðftfufhfjfcf" ,É•aŠ,,μAftfufhfjfcf" ,ìŠÇ— □,í•É,ì'g□D,É`ì'ð,μ,Ü,·BŠefhfjfcf" ,É,í^è^Ó-¼,`a ,èAftfufhfjfcf" ,É,lfhfjfcf""à,Ä,î^è^Ó-¼,`a ,è,Ü,·BŠeflfbfgf[fN fm[fh,lf%xf<,íA63 •¶Žš^É"à,ì¶Žš,©,ç,È,é-¼'O,Ä,·BFQDN (Fully Qualified Domain Name; Š'Š□□üfhfjfcf"-¼) ,Æ,íAfc□[fg,É-ß,è,Ü,Ä,ìæ□sfm□[fh-¼,ð,·,x,ÄŠÜ,pAInternet ã,lfzxfjg,ì^è^Ó-¼,Ä,·B,½,Æ,ì,íA ,é%oc—`c'ì,lfzxfjg,ì DNS -¼,íAŽÿ,ì,æ,æ,É,È,è,Ü,·B accounting.trey.com

ftfufhfjfcf" ,`a`ã,« ,A'Ç%Á,ìftfufjfbfg,`aŠÜ,Ü,è,éèè#Afczxfjg,lfafhfcejx,É,íAftfufjfbfg fcfš[□,ì'Ç%Á,lf %ofxf<,`aŠÜ,Ü,è,Ü,·B

DNS ,Ä,íAfnf%fcfjfcf"fg f□[fo□[ f,fff<,`aŽg,ì,è,Ä,ç,Ü,·BDNS f□[fo□[ ,íADNS fff[f^fx[fX,ì^è•",ì□î•ñ,ðŠÜ,ñ,Ä,`",è□A,±,ì□î•ñ,ðAflfbfgf[fN,ì<«ŠE,ð%oz,ì,Äf□[f€ f□[fo□[ ,ð□Æ %oi,·,éfnf%fcfjfcf"fg (fšj)fcfo) ,`aŽg,ì,è,æ,æ,É,μ,Ü,·BDNS fl[f€ f□[fo□[ ,Æ,íAfc□[f" ,ÆCEÄ,î,è,éfhfjfcf"

f[]f€ fXfy[]fX,ì'è•",ÉŠÖ,·,é[]î•ñ,ðŠi"l,μ,Ä,ç,évf[]fOf%of€,ì,±,Æ,Å,·[]Bfhf[]fCf",ìŠÇ—[]ŽÒ,í[]Af[]f€  
fT[]fo[],ðÝ'è,μ,Ü,·[]B,±,ìf[]f€ fT[]fo[],É,í[]Aff[]f^fX[]fX  
ftf@fCf<,³Si"l,³,è,Ä,·,è[]A,»,"ì†,É,í[]Af[]f""à,ì'SfzfXfg,ÉŠÖ,·,éŠf[]fX f€fR[]fh,³,·,×,Ä<L[]q,³,è,Ä,ç  
,Ü,·[]BDNS fŠfjfo,í[]Af[]f€ fT[]fo[],ðŽg,Á,Äfhf[]fCf" f[]f€ fXfy[]fX,ÉŠÖ,·,é[]î•ñ,ì"üŽè,ðŽŽ,Ý,éfnf  
%ofCfAf"fg,Å,·[]B

Windows NT ,É,í[]ADNS fŠfjfo<@"\,³ŠÜ,Ü,è,Ä,·,è[]ANetbt ,·,æ,Ñ ftp ,â telnet ,Æ,ç,Á,½ Windows  
Sockets []Ú'±fAfvfŠfP[]fVf#",í[]A,±,ì<@"\,ðŽg,Á,Äf[]f€ fT[]fo[],ð[]Æ%oi,μ[]A,»,ì%ž"š,ð%ðŽŽ,μ,Ü,·[]B

DNS ,ìŽà,Èf^fXfn,í[]Af[]fU[],É,í,©,è,à,·,ç-¼'O,ð'ñ<ÿ,·,é,±,Æ,Æ[]A,»,è,ç,ì-  
¼'O,ðfCf"f^[]f[]fbfgf[]fN,Å•K—v,È IP fAfhf€fX,Ö%ðCE^,·,é,±,Æ,Å,·[]B-¼'O%ðCE^,í[]Af[]f€ fT[]fo[],<sup>a</sup>  
DNS ,ð'È,¶,Ä[]s,ç,Ü,·[]Bf[]f€ fT[]fo[],í[]AFQDN "à,ì[]î•ñ,ð%ðŽŽ,μ,Ä[]A"Á'è,ìfAfhf€fX,ð'T,μ,Ü,·[]Bf[]f<  
f[]f€ fT[]fo[],<sup>a</sup>í[]A[]Æ%oi,Á—v<[]<sup>3</sup>,è,½ff[]f^,ðŽg,Á,Ä,ç,È,ç[]ê[]±[]Af[]f€ fT[]fo[],í[]A,±,ì[]î•ñ,ðŽg,Á,Ä,ç,é  
%oÅ"[]«,³,è,Ü,©,ìf[]f€ fT[]fo[],ì-¼'O,ÆfAfhf€fX,ð•Ô,μ,Ü,·[]BŽÿ,É[]AfŠfjfo,í[]A•K—v,È-  
¼'O,ÆfAfhf€fX,<sup>a</sup>CE©,Ä,©,é,Ü,Ä[]A,Ü,©,ìf[]f€ fT[]fo[],ð[]Æ%oi,μ,Ü,·[]Bf[]f€ fT[]fo[],í[]A[]Æ  
%oi,ìCE<%oÈ,Æ,μ,Äfhf[]fCf" f[]f€ fXfy[]fX,É,Ä,ç,ÄŠw[]K,μ,½[]î•ñ,ðCEp'±"l,Éflfff[]fVf...,μ,Ä,ç,é,ì,Ä[]A,±  
,ìŽè[]#,í[],'¬,É[]^—[]<sup>3</sup>,è,Ü,·[]B

Internet []ã,Å DNS ,ðŽg—p,·,é,ì,É•K—v,ÈfŠfjfo f[]ftfgfEjFfA,Í,·,×,Ä[]AMicrosoft TCP/IP  
,ì'g,Ý[]ž,Ý,ì[]Ú,É[]A,ç,Á,μ,â,É'g,Ý[]ž,Ü,è,Ü,·[]B-¼'O%ðCE^,É DNS ,ðŽg—p,·,é,É,í[]A[DNS ,ì[]\[]¬] f\_jCfAf[]fO  
f{fbfNfX,Äf[]fvfVf#",ðŽw'è,μ,Ü,·[]B

ŠÖ~A[]€-Ú

DNS ,ðŽg—p,·,é,½,ß,É TCP/IP ,ð[]\[]¬,·,é

**fzfXfg ftj@fCf<,đŽg,Á,½-¼'O%ođCE^**

WINS ,đŽg,í,È,čfŠf,[]fg fTfufjfbfg,É"z'u,³,è,Ä,č,éRf"fsf...[]f^,Á,íA-¼'O,©,ç IP  
fAfhfCefX,Ö,lf}fbfsf"fO,íAHOSTS ftj@fCf<,"æ,Ń LMHOSTS ftj@fCf<,É,æ,è'ň<Ÿ,³,è,Ü,·B,±,ì-¼'O  
%ođCE^,ì•û-@,íADNS ,",æ,Ń WINS ,ªŠj",³,è,é'O,ÉfCf"f^[]fjfbfgf[]fN,ÁŽg,í,è,Ä,č,Ü,μ,½BHOSTS  
ftj@fCf<,íAf[]ffj< DNS ,É"™,μ,č,à,ì,Æ,μ,Ä~—p,·,é,±,Æ,ª,Á,«,Ü,·BLMHOSTS ftj@fCf<,íAf[]ffj< WINS  
,É"™,μ,č,à,ì,Æ,μ,Ä~—p,·,é,±,Æ,ª,Á,«,Ü,·B,Ç,¿,ç,lfTj@fCf<,àAfzfXfg fe[]fuf<,Æ,μ,Ä'm,ç,è,Ä,č,Ü,·B  
fTf"fvf< LMHOSTS ftj@fCf<,"æ,ŃfTf"fvf< HOSTS ftj@fCf<,íAMicrosoft TCP/IP ,đ'g,Ý[]ž,p,Æ,«A\WINNT\  
SYSTEM32\DRIVERS\ETC fffBfCefNfgfŠ,É'Ç%oÁ,³,è,Ü,·B,±,è,ç,lfTj@fCf<,íAWindows NT ,É•t'®,μ,Ä,č  
,éf[]f,' ,Ü,½,lf%ofCf<,È,Ç,ì ASCII fGfffBf^,đŽg,Á,Ä•Ò[]W,Á,«,Ü,·B

LMHOSTS ftj@fCf<,íAWINS -¼'O%ođCE^ ,Ü,½,lfuf[]f[]fhfLfffXfg-¼'O%ođCE^,ªŽ,"s,μ,½,Æ,«"Ç,ÝŽæ,ç,èA  
%ođCE^,³,è,½fGf"fGfŠ,íACEä,lfAfNfZfX,ì,½,ß,ÉfVfXfef€ fLfffbfVf...,ÉŠi"l,³,è,Ü,·B

fRf"fsf...[]f^,ª WINS ,đŽg,í, ,É•;[]» (replicator) fT[]fX,đŽg,Á,Ä,č,é[]é[]#[]A•;[]»,ÉŽQ%oÁ,μ,Ä,č  
,é^Ü,È,éTfufjfbfg[]ä,lfRf"fsf...[]f^,ì,½,ß,lfCf"f[]fg fT[]fo[],",æ,ŃfGfNfXf[]fg fT[]fo[],É,í LMHOSTS  
fGf"fGfŠ,ª•K—v,Á,·BLMHOSTS ,íAfT[]fo[],ª'¶[]Ý,μ,È,č[]-<K-lfjfbfgf[]fN,Á,àŽg,í,è,Ü,·B

ŠÖ~A[]€-Ú

LMHOSTS.ì[]Ý'è









,Æ“ü—Í,μ,Ü,·□B

Windows Sockets fvf□fOf%of~f“fO,É,Â,ç,Ä,ì^ÓŒ©,ðŒðŠ,·,é,½,ß,É—p^Ó,³,ê,½“dŽqf□□[f<  
fŠfXfg,à, ,è,Ü,·□B

**Windows Sockets f□□[f< fŠfXfg,ð□\,μ□ž,þ,É,Í**



“dŽqf□□[f<,ð listserv@sunsite.unc.edu ,É’—□M,μ,Ü,·□Bf□bfZ□[fW- {•¶,É,í□A□g**subscribe**  
**winsock** user's e-mail-address□h,ðŠÜ,ß,Ü,·□B  
,±,ê,Æ“~ ,¶Žè□ž,Á□A**winsock-hackers** ,” ,æ,Ñ **winsock-users** ,Æ,ç,æ-¼‘O,ì 2 ,Â,lf□□[f<  
fŠfXfg,ð□\,μ□ž,þ,±,Æ,ª,Á,«,Ü,·□B

## DHCP fT[f]o[l, ižg—p, É, Â, ç, Ä

DHCP (Dynamic Host Configuration Protocol; “®“lfzfXfg\—fvf\fgfRf<) fT[f]o[l, /E, íAMicrosoft TCP/IP ,/E DHCP fT[f]o[l f\ftfgfEJfA, ðŽÄs, μ, Ä, ç, é Windows NT Server fRf“fsf... [f^, ì, ±, /E, Ä, ·BDHCP , íARFC (Requests for Comments) 1533A1534A, ”, æ, Ñ 1541 , É’è<` , ³, ê, Ä, ç, Ü, ·BDHCP fT[f]o[l, ì<@“\ , íAWindows NT Server , Ä, ì, Ý—LCEø, Ä, ·B

, ±, ±, Ä, íAfCf“f^ [f\fbfgf [fN, ì<K-í, ÉŠî, Ä, «ADHCP , ì<@“\, ðfTf [fg, , éfT [fo [l, ð Windows NT , É’g, Ýž, p•û-@A, Ü, ½ADHCP , ð“±“ü, , é, ½, ß, ìfvf%of“fj“fo, ì•û-@, É, Ä, ç, Ä, àà-¾, μ, Ü, ·BŽÝ, ì, æ, x, È€- Ü, É, Ä, ç, Äà-¾, μ, Ü, ·B

 [DHCP fNf%ofCfAf“fg fT\[f\]o\[l f.fff<, ìŠT—v](#)

 [DHCP fT\[f\]o\[l, ð’g, Ýž, p](#)

 [DHCP \(“®“lfzfXfg\—fvf\fgfRf<\)](#)

## DHCP fNf%oCfAf“fg fT[]fo[] f,fff<,iŠT—v

fjfbfgf[]fN,É DHCP fT[]fo[],đ[]&¬,·,é,Æ[]AZÿ,ì,æ,æ,È—“\_ª, ,è,Ü,·[]B



fjfbfgf[]fNŠC—žò,í[]AfCf“f^[]fjfbfgf[]fN‘S‘ì,É‘í,µ,Ä TCP/IP ,ífOf[][]fof< fpf %ofo[]f^[]A,“ ,æ,ÑfTfufjfbfg,ÉCEÀ—L,lfpf%ofo[]f^,đ[]W‘t“l,Éžw‘è,·,é,±,Æ,ª,Ä,«,Ü,·[]B,Ü,½[]A—\—ñ,³,è,½ IP fAfhfCEfX,đžg,æfNf%oCfAf“fg,lfpf%ofo[]f^,đžw‘è,·,é,±,Æ,ª,Ä,«,Ü,·[]B



fNf%oCfAf“fg fRf“fsf...[]f^,Ä,í[]ATCP/IP ,đžè“ @,Ä[]&¬,·,é•K—v,ª, ,è,Ü,¹,ñ[]BfNf%oCfAf“fg fRf“fsf...[]f^,æfTfufjfbfgŠO,đ‘Ú“ @,µ,½[]é[]±,à[]AfVfXfef€,đ<N“ @,·,é,Æž“ @“l,É TCP/IP ,ª[]Ä[]&¬,³,è,Ü,·[]B

DHCP ,í[]AfNf%oCfAf“fg fT[]fo[] f,fff<,đ[]—p,µ,Ä,ç,Ü,·[]BDHCP fT[]fo[] ,đ 1 ‘ä,ü,½,í,·;[]“äÝ“è,µ,Ä,“ , ,í[]ADHCP fT[]fo[],í—v<[] ,é fNf%oCfAf“fg,É‘ñ<ÿ,·,é TCP/IP [] &¬[]•ñ,đ•Üžç,µ,Ü,·[]BfT[]fo[] ff[]f^fx[]fX,É,í[]AZÿ,ì,æ,æ,È[]î•ñ,ªŠi“l,³,è,Ä,ç,Ü,·[]B



f[][]fjfbfgf[]fN,·,x,Ä,lfNf%oCfAf“fg,É—LCEø,È[]&¬—fpf%ofo[]f^



fNf%oCfAf“fg,Ö,ìŠ,,,è“—,Ä—p,Éfv[]f<,³,è,½—LCEø,È IP fAfhfCEfX[]A,“ ,æ,Ñžè“ @Š,,,è“—,Ä—p,É—\—ñ,³,è,½fAfhfCEfX



fT[]fo[], ©,ç‘ñ<ÿ,³,è,é fŠ[]fX,â,» ,ì,Ü, ©,í[]&¬—fpf%ofo[]f^,ì—LCEøŠúŠÔ[]BfŠ[]fX,Ä,í[]AŠ,,,è“—,Ä,ç,è,½ IP fAfhfCEfX,đžg—p,Ä,«,éŠúŠO,í‘è< ,³,è,Ä,ç,Ü,·[]B

[Windows NT TCP/IP ‘g,Ý[]ž,Ýfjfvfjfbfg“] f fCfAf[]fo f{fbfNfX,Ä[]A[DHCP ž“ @[]&¬,·,è—LCEø,É,·,é] f`fjfbfgf f{fbfNfX,đfjfbfg“ ,É,µ,Ä,ç,é,Æ[]AWindows NT fRf“fsf...[]f^,í DHCP fNf%oCfAf“fg,É,È,è,Ü,·[]BDHCP fNf %oCfAf“fg fRf“fsf...[]f^,í[]A<N“ @CEã[]ADHCP fT[]fo[],Æ‘É[]M,µ,Ä[]A•K—v,È TCP/IP [] &¬[]&¬[]•ñ,đžó,žæ,è,Ü,·[]B,±,ì[]&¬—[]î•ñ,É,í[]A[] ,È,Æ,à IP fAfhfCEfX,Æ fTfufjfbfg f}fXfN,ªŠÜ,Ü,è,Ä,“ ,è[]A,³,ç,É,±,ì[]&¬—,ÉŠÖ~A,·,é fŠ[]fX[]î•ñ,ªŠÜ,Ü,è,Ä,ç,Ü,·[]B

DHCP fNf%oCfAf“fg,ª[]&¬—[]î•ñ,đ“ @“l,Éžæ“¾,·,é<@“l,í[]Afjfbfgf[]fN fuf[][]fhfLfffXfg,ÉŠì,Ä,ç,Ä,ç ,é,½,ß[]A,Ü, ©,ì IP fTfufjfbfgf[]fN[]ä,ì DHCP fT[]fo[], ©,ç DHCP fNf%oCfAf“fg,ì[] &¬[]&¬[]•ñ,đ“¾,é,É,í[]Afjfbfgf[]fN,ì IP f<[]f^[] ,ìfTf[]f[]g,ª•K—v,Ä,·[]Bžã—v,Éf<[]f^[] ,ìfxf“f\_[] ,í[]ADHCP fšfCE[] fG[]fWfFf“fg,ìfTf[]f[]g (DHCP fCf“f^[]fjfbfg RFC ,É<L[]q) ,đf<[]f[]efBf“fo fftfgfEfffA,É‘ç%oÄ,µ,Ä,ç ,é,Æ,±,è,Ä,·[]B

DHCP ,ìžÄ‘•,Ä,í[]A,Ä,«,éCEÀ,è‘½,,ìfefXfg,ª[]s,í,è,Ü,µ,½,ª[]Af<[]f^[] ,ì—à‘è,đ %ođCE^ ,·,é,É,í[]Af<[]f^[] ,ìfxf“f\_[] ,É—à,ç[]±,í,¹,é,±,Æ,đ,“Š ©,ß,µ,Ü,·[]BMicrosoft ,í[]ACisco[]AProteon[]AWellfleet[]A,“ ,æ,Ñ 3Com ,È,Ç,ìŠefxf“f\_[] ,ìfTf[]f[]g,·,éfo[]fWfjfbfg“ ,ìf ftfgfEfffA,ìfefXfg,đ[]s,ç,Ü,µ,½[]B,±,è,ç,ìf<[]f^[] ,ìfftfgfEfffA,É,Ä,ç,Ä,í[]Af<[]f^[] ,ìfxf“f\_[] ,É—à,ç[]±,í,¹,Ä,- ,¾,¾,ç[]B

‘[] : 1 ‘ä,ì DHCP fT[]fo[],Ä[]A•;[]“ ,ìf<[]f^[] ,É,Ü,½,ª,æfTfufjfbfgf[]fN,đfTf[] []f[]g,µ,½,ç[]é[]±,í[]Af<[]f^[] ,ìfTf[]f[]gEfffA,đfAfbfvfOfCE[]fh,µ,È, ,é,í,È,ç,È,ç[]é[]±,ª, ,è,Ü,·[]B,» ,ì é[]±[]Af<[]f^[] ,í RFC 1532[]A1533[]A,“ ,æ,Ñ 1541 ,đfTf[]f[]g,µ,Ä,ç,é,à,ì,Ä,È, ,é,í,È,è,Ü,¹,ñ[]BDHCP fšfCE[] fG[]fWfFf“fg,ìfTf[]f[]g,É,Ä,ç,Ä,í[]Af<[]f^[] ,ìf[]f[]g[] ,É—à,ç[]±,í,¹,Ä,- ,¾,¾,ç[]B,æ,è[]Ú,µ,ç[]î•ñ,É,Ä,ç,Ä,í[]ARFC1541.TXT ,đžQ[]Æ,µ,Ä,,¾,¾,ç[]B,±,è,í[]A“½—¼ FTP ,É,æ,è ftp.internic.net:/rfc , ©,ç“üžè,Ä,«,Ü,·[]B

**DHCP fT[f]o[f],đ'g,Ýž,þ**

DHCP fT[f]o[f],íAMicrosoft TCP/IP ,đ'g,Ýž,þ%ß'ö,Á'g,Ýž,þ,±,Æ,ª,Á,«,Ü,·B

**DHCP fT[f]o[f],đ'g,Ýž,þ,É,í**

1. fRf"fgf[f< fpjlf<,ÁA[fjfbfgf[fN] ,đf\_fuf<fNšfbfN,µ,Ü,·B[fjfbfgf[fN,ìY'è] f\_fCfAfFO f{fbfNfX,ª•\Ž!,³,è,½,çA[fjftfgfEjFfA,ì'Ç%Á] f{f^f",đfNfšfbfN,µ,Ü,·B[fjfbfgf[fN fjtfgfEjFfA,ì'Ç %Á] f\_fCfAfFO f{fbfNfX,ª•\Ž!,³,è,Ü,·B
2. [fjfbfgf[fN fjtfgfEjFfA] ^è—,©,çA[TCP/IP fvfgfRf<,ÆŠÖ~ AfvfgfRf<] ,đ'í'ð,µA[±s] f{f^f",đfNfšfbfN,µ,Ü,·B[Windows NT TCP/IP 'g,Ýž,ÝfjfvfVfj" f\_fCfAfFO f{fbfNfX,ª•\Ž!,³,è,Ü,·B
3. 'g,Ýž,þfjfvfVfj" ,ìf' fFbfN f{fbfNfX,đfj" ,É,µ,Ü,· ([DHCP fT[f]o[f] fT[f]rfX] f' fFbfN f{fbfNfX,í•K, ,fj" ,É,µ,Ü,·)B  
Microsoft TCP/IP ,ª, ,Á,ÉfRf"fsf...[f^ã,É'g,Ýž,Ü,è,Ä,ç,éèþ,íA[DHCP fT[f]o[f] fT[f]rfX] f' fFbfN f{fbfNfX,đfj" ,É, ,é,¾, ,Á,·B
4. [OK] f{f^f",đfNfšfbfN,µ,Ü,·BWindows NT fZfbfgfAfbfv,íAWindows NT Server "z•zftf@fCf<,Ö,ìftf< fpjX,ì"ü—í,ð<,ß,éf\_fCfAfFO f{fbfNfX,đ•\Ž!,µ,Ü,·B"KØ,ÉfpjX,đžw'è,µA[±s] f{f^f",đfNfšfbfN,µ,Ü,·B  
•K—v,Éftf@fCf<,ª, ,x,Äfn[fh fffBfXfN,ÉfRfs[ ,³,è,Ü,·B
5. TCP/IP ,ì\—,É•K—v,È, ,x,Ä,ìžèþ,đžè"®,ÁŠ®—¹,µ,Ü,·BTCIP/IP ,ì'g,Ýž,Ý,ìŠ®—¹Çä,ÉA[fjfbfgf[fN,ìY'è] f\_fCfAfFO f{fbfNfX,ªÁ,Ñ•\Ž!,³,è,½,çA[—¹] f{f^f",đfNfšfbfN,µ,Ü,·B

' : DHCP fT[f]o[f],íA,Á,È,É IP fAfhfCfX,¾, ,Á•\,³,è,é,½,ßADHCP ,đžg,Á,Äµ,ç DHCP fT[f]o[f],ð\—, ,é,±,Æ,í,Á,«,Ü,¹,ñB

fRf"fsf...[f^,đÄ<N"®, ,é,ÆA'í%ž, ,é TCP/IP fjtfgfEjFfA, ,æ,Ñ DHCP fjtfgfEjFfA,íA, ,x,Äžg—p, ,é€"ö,ª®,ç,Ü,·B

DHCP fT[f]o[f],đ'g,Ýž,ñ,¾ÇäADHCP f}f[fWff,ìfc[f<,đžg,Á,ÄŽÝ,ì,æ,x,Èšì- {<Æ,ðs,í,È, ,é,ì,È,è,Ü,¹,ñB



DHCP fXfR[fv,đ'è< , ,é  
DHCP fT[f]rfX,đŠjŽn, ,é,½,ß,É•K—v,Èî•ñ,đ"¾,é,½,ß,ÉADHCP fT[f]o[f],đ DHCP fXfR[fv,É'Ç %Á,µ,Ü,·B,Ü,½A,»,ìfXfR[fv"à,ì DHCP fNf%ofCfAf"fg,ÉfT[f]o[f],ªŠ,,è"—,Á,é IP fAfhfCfX,ì"í,È,ÇAfXfR[fv,ì'®« ,đ'è< ,µ,Ü,·B



DHCP fjfvfVfj" f^fCfv,ð\—, ,é  
fŠ[fXšÖ,È,Ç,ìfjfvfVfj" ,ìfftfHf<fg'l,đ'è< ,µ,Ü,·B,Ü,½,íAfjXf^fè fjfvfVfj" ,đ'Ç%Á,µ,Ü,·B

ŠÖ~A€-Ú

TCP/IP ,ð\—, ,é

DHCP fT[f]o[f] fT[f]rfX,ìŠjŽn,Æ'âž~

## DHCP fT[f]o[f] fT[f]rfX,İŠJŽn,Æ'âŽ~

DHCP fNf%ofCfAf"fg fT[f]rfX,ÍAWindows NT f[f]NfXfe[f]Vf#f" fRf"fsf...[f^]ã,ÅŽÀ[s,³,ê,é Windows NT fT[f]rfX,Ä,·B,±,İfT[f]rfX,đTf|f]g,·,é DHCP fNf%ofCfAf"fg f\ftgfEjFfA,ÍASİ-{"I,ÈfIfyfCE[f]efBf"fo fVfXfef€,ª'g,Ýž,Ü,ê,é,ÆAWindows NT Server fRf"fsf...[f^],Æ Windows NT Workstation fRf"fsf... [f^],ÉŽ©"®"I,É'g,Ýž,Ü,ê,Ü,·B

## DHCP fT[f]o[f] fT[f]rfX,đŠJŽn,Ü,½,Í'âŽ~,·,é,É,Í

1. fRf"fgf[f]f< fpf|f<,ÅAW[f]rfX] ,đ\_fuf<fNfŠfbfN,μAMicrosoft DHCP fT[f]o[f] fT[f]rfX,đ'I'đ,μ,Ü,·B  
[f] ,Ü,½,Í [f]

fT[f]o[f] [f]f|fWff,ÅAW[f]rf"fsf...[f^] f[f]f...[f],İ [fT[f]rfX] fRf}f"fh,đ'I,Ñ,Ü,·B

2. [fT[f]rfX] (fT[f]o[f] [f]f|fWff,Ä,Í [f]`,İfT[f]rfX) f\_CfAf[f]O f{fbfNfX,Ä  
[ŠJŽn]AW[âŽ~]AW[èŽŽ'âŽ~]AW,Ü,½,Í [f±]s] f{f^f",đfNfŠfbfN,μA'±,ç,Ä [f]—<sup>1</sup>  
f{f^f",đfNfŠfbfN,μ,Ü,·B

DHCP fT[f]o[f] fT[f]rfX,ÍAWfRf}f"fh fvf[f]fvfg,ÅAW **Anet start dhcpserver**AW **stop  
dhcpserver**AW **pause dhcpserver**AW **continue dhcpserver** fRf}f"fh,đ"ü—  
Í,μ,Ä,àASJŽnAW[âŽ~,·,é,±,Æ,ª,Ä,«,Ü,·B

## WINS fT[f]o[f],lžg—p,É,Â,ç,Ä

WINS fT[f]o[f],Æ,íAMicrosoft TCP/IP ,”æ,Ñ WINS (Windows Internet Name Service; Windows fCf“f^[]f]fbfg f[]f€ fT[]f]rfX) fT[]f]o[f] f]ftfgfEjFfA,žŽÀ[]s,·,é Windows NT Server fRf“fsf...[]f^,ì,±,Æ,Ä,·BWINS fT[]f]o[f],íATCP/IP fAfhfÆfX,žfRf“fsf...[]f^-¼,É•İŠ·,·,éff[]f^fx[]fX,ž•ŮŽç,μ,Ů,·B,±,é,É,æ,Á,ÄATCP/IP ,žŽg,xf]fbfgf[]fN[]ä,É WINS fT[]f]o[f],ª, ,é,Æ,«A,·,×,Ä,ìft[]f]U[]ª TCP/IP ,ì—~“\_ž¹,È,æ,±,Æ,È,AWindows f]fbfgf[]fN fRf“fsf...[]f^-¼,žŽg,Á,Ä,Ů,©,ìfRf“fsf...[]f^,ÆŠÈ’P,É’É[]M,·,é,±,Æ,ª,Ä,«,Ů,·B

,±,±,Ä,íAWindows NT ,ì WINS <@“\,žfTf]o[f],·,é,½,ß,É WINS fT[]f]o[f],ž’g,Ýžž,p•Ů-@A,·,æ,Ñ WINS ,ì”wÆi,É,Ä,ç,Ä[]à-¾,μ,Ä,ç,Ů,·B

 WINS fT[]f]o[f],ž’g,Ýžž.p

 WINS ,ì—~“

 WINS ,Æfuf[]f]hfLfffXfg-¼’O%žžCE^

'[] : WINS fT[]f]o[f],íAWindows NT Server ,Ä,ì,Ý[]ì[]-,·,é,±,Æ,ª,Ä,«,Ů,·B

## WINS fT[f]o[l,đ'g,Ýž,þ

WINS fT[f]o[l,íAWindows NT Server ,É Microsoft TCP/IP

,đ'g,Ýž,þžèþ,ì^è" ,Æ,μ,Ä'g,Ýž,Ý,Ü,·B WINS fT[f]o[l,đŽÀs,·,éfRf"fsf...[f^,íACEÁ'è,μ,½ IP fAfhfCEfX,đŠ,,è"-,Ä,ç,è,Ä,ç,é•K—v,ª, ,è,Ü,·B,Ü,½AWINS fT[f]o[l fRf"fsf...[f^,íADHCP fNf %ofCfAf"fg,Ä, ,Ä,Ä,í,È,è,Ü,¹,ñBWINS fT[f]o[l fRf"fsf...[f^,É•i",ìfifbfgf[fN fAf\_fvf^ f][fh,ª, ,éèèþAIP fAfhfCEfX,ìCE<þþþ",ª³,μ,ç,±,Æ,đŠm" F,μ,Ä,,¾,¾,çþB

' : f [f]f f Rf"fsf...[f^,Ä WINS f}f][fWff,đ'g,Ýž,ÝAZÀs,·,é,É,íAAdministrators fOf<[fv,ìf"fo[l,Æ,μ,ÄfOfOf",μ,È, ,è,ì,È,è,Ü,¹,ñB

## WINS fT[f]o[l,đ'g,Ýž,þ,É,í

1. fRf"fgf[f< fpf[f<,ì [fifbfgf[fN] ,đf\_fuf<fNfŠfbfN,μ,Ü,·B [fifbfgf[fN,ìY'è) f\_fCfAf[fO f{fbfNfX,ª•Ž!,³,è,½,çA[fvtfgfEfffA,ì'Ç%oÁ] f{f^f",đfNfŠfbfN,μ,Ü,·B [fifbfgf[fN fvtfgfEfffA,ì'Ç %oÁ] f\_fCfAf[fO f{fbfNfX,ª•Ž!,³,è,Ü,·B
2. [fifbfgf[fN fvtfgfEfffA] ^è—, ©,çA[ TCP/IP fvf[fgfRf<, ,æ,ÑŠÖ~Afrf" f[f"fg] ,đ'í'đ,μA[±s] f{f^f",đfNfŠfbfN,μ,Ü,·B [Windows NT TCP/IP 'g,Ýž,ÝfifvfVf#"] f\_fCfAf[fO f{fbfNfX,ª•Ž!,³,è,Ü,·B
3. 'g,Ýž,þfifvfVf#",đ'í,Ñ,Ü,·B [WINS fT[f]o[l fT[f]rfX] f'fFfbfN f{fbfNfX,í•K, ,í,Ñ,Ü,·B Microsoft TCP/IP ,ª, ,Ä,ÉfRf"fsf...[f^,É'g,Ýž,Ü,è,Ä,ç,éèèþ,íA[WINS fT[f]o[l fT[f]rfX] f'fFfbfN f{fbfNfX,đfif",É, ,é,¾, ,Ä,·B
4. [OK] f{f^f",đfNfŠfbfN,μ,Ü,·B Windows NT fZfbfgfAfbfv,É,æ,èAWindows NT Server "z•zftf@fCf<,Ö,ìftf< fpfX,đ-à,çþ,í,¹,éf[fbfZ[fW,ª•Ž!,³,è,Ü,·B "K∅,ÈfopfX,đ"ü—í,μA[±s] f{f^f",đfNfŠfbfN,μ,Ü,·B  
•K—v,Èftf@fCf<,ª, ,x,Äfn[fh fffBfXfN,ÉfRfs[l,³,è,Ü,·B
5. TCP/IP ,ì∅—,É•K—v,ÈŽèþ,đ, ,x,ÄŠ@—¹,μ,Ü,·B Ú×,É,Ä,ç,Ä,íA TCP/IP ,đ∅—, ,é,đŽQ∅Æ,μ,Ä, ,¾,¾,çþB TCP/IP ,ì∅—,đŠ@—¹, ,é,ÆA[fifbfgf[fN,ìY'è) f\_fCfAf[fO f{fbfNfX,ª•Ž! "x•Ž!,³,è,Ü,·B [∅—¹] f{f^f",đfNfŠfbfN,μ,Ü,·B

fRf"fsf...[f^,đÄ<N" @, ,é,ÆA'í%ož, ,é TCP/IP , ,æ,Ñ WINS fT[f]o[l,ìfvtfgfEfffA,đ, ,x,ÄŽg— p,Ä,«,é,æ,æ,É,È,è,Ü,·B

ŠÖ~A∅€-Ú

WINS fT[f]rfX,đŠ]Žn, ,æ,Ñ'âŽ~, ,é

## WINS fT [frfX, ŠŽn, ,æ, Ń'âž~, ,é

WINS fNf%ofCfAf"fg fT [frfX, íAWindows NT Workstation fRf"fsf... [f^ ä, ÅŽÅs, ³, è, é Windows NT fT [frfX, Å, ·B, ±, ìfT [frfX, ðfTf [fg, ,é WINS fNf%ofCfAf"fg fVtfgfEfFfA, íAŠî- {fVfXfef€ ,ð'g, Ýž, p, ÆAWindows NT Server fRf"fsf... [f^ , ,æ, Ń Windows NT Workstation fRf"fsf... [f^ , ÈŽ © "® "l, È'g, Ýž, Ü, è, Ü, ·B

Windows fCf" f^ [fVfbfg f [f€ fT [frfX, íAWINS fT [fo [ [ä, È'g, Ýž, Ü, è, ½fT [fo [ fVtfgfEfFfA, Å, ·B

## WINS fT [fo [ fT [frfX, ŠŽn, ,æ, Ń'âž~, ,é, É, í

1. fRf"fgf [f< ppf [f< , Å [fT [frfX] , ðf\_fuf< fNfŠfbfN, µA [Windows fCf" f^ [fVfbfg f [f€ fT [frfX] , ð'ð, µ, Ü, ·B  
- , Ü, ½, í -

fT [fo [ f] f [fWff, ÅA [fRf"fsf... [f^ ] f [f... [ , ì [fT [frfX] fRf} f"fh, ð'í, Ń, Ü, ·B

2. [fT [frfX] (fT [fo [ f] f [fWff, Å, í [ ] , ìfT [frfX]) f\_fCfAf [fO f {fbfNfX, ÅA [ŠŽn] A [ 'âž~ ] A [ ^êžž'âž~ ] A, Ü, ½, í [ '±s ] f {f^ f" , ðfNfŠfbfN, µA [ [ -¹ ] f {f^ f" , ðfNfŠfbfN, µ, Ü, ·B

fRf} f"fh fVf [f" fVfg, ÅA fRf} f"fh **net start wins** , Ü, ½, í **net stop wins** , ð"ü—í, µ, ÅAWINS fT [frfX, ŠŽn, Ü, ½, í'âž~, ,é, ±, Æ, à, Å, «, Ü, ·B

## WINS , ì^êžž'âž~, Æ'±s

fRf"fgf [f< ppf [f< , ì [fT [frfX] , ðŽg, x, ©A, Ü, ½, ìfRf} f"fh fVf [f" fVfg, Å **net pause wins** , Ü, ½, í **net continue wins** fRf} f"fh, ð"ü—í, ,é, ±, Æ, É, æ, Å, ÅAWINS , ð^êžž'âž~, µ, ½, èA^êžž'âž~, ð%ðœ, µ, Å [ - , ð'±s, ,é, ±, Æ, a, Å, «, Ü, ·B ^êžž'âž~'t, ìA fNf%ofCfAf"fg, ©, ç, ì-¼'OfpfPfbfg, ðŽó, - •t, - , Ü, ¹, ñBWINS ŠÇ—ŽÖ, í, ±, è, É, æ, Å, ÅAŠÇ—A • ; [ »ACEĀ, t fCEfR [fh, ì [ ' ] , È, Ç, ìŠÔA fNf%ofCfAf"fg, a WINS , ðŽg— p, µ, È, ç, æ, x, È, ,é, ±, Æ, a, Å, «, Ü, ·B





## LMHOSTS ,ìŸ'è

LMHOSTS ftf@fCf<,íA'ÉíAWindows flfbfgf[]fN,ìftf@fCf< fT[]frfX[]A^óüfT[]frfX[]A,¨,æ,ÑfŠf,[]fg  
fT[]frfX,È,Ç,ì,½,ß[]A, ,é,ç,íffOfif“[]AŽQ[]Æ[]A•;[]»»,È,Ç,ì,æ,æ,Èfhf[]fCf“ fT[]frfX,ì,½,ß,É[]AfŠf,[]fg fRf“fsf...  
[]f^,ðCE©,Â,¯,é,½,ß,ÉŽg,í,ê,Ü,·[]B



LMHOSTS ftf@fCf<,ð•Ò[]W,·.é



“@“|~¼'O%ðCE^,É LMHOSTS ,ðŽg,æ



fzfXfg ftf@fCf<,ðŽg,Á,½~¼'O%ðCE^

## LMHOSTS ftj@fCf<,đ•ÒW,·,é

Windows NT ,ÅŽg—p,³,ê,é LMHOSTS ftj@fCf<,É,Í AIP fAfhfĀfX,Æ Windows NT fRf“fsf...[]f^~¼  
(NetBIOS ~¼) ,Æ,đ'Í%ž•t,̄,éf}fbfsf“fO[]•ň,³ŠÜ,Ü,ê,Ä,č,Ü,·B,±,İftj@fCf<,Í AMicrosoft LAN Manager  
2.x TCP/IP LMHOSTS ftj@fCf<,ÆĀÝŠ·[]«,ª, ,è,Ü,·B

ft[]fU[],Í Af[]f, ' ,â,Ü,©,İfefLjXfg fGfffBf^,đŽg,Á,Ä A\systemroot\SYSTEM32\DRIVERS\ETC  
fffBfĀfNfgfŠ,ÉŽ © “ @ “ I,É'g,Ýž,Ü,ê,Ä,č,éfTf“fvf< LMHOSTS ftj@fCf<,đ•ÒW,Á,«,Ü,·B

LMHOSTS ,ÉŠÖ,·,éŠİ-{“I,È<K'¥,ÆfKfCfhf%ofCf“ ,É,Á,č,Ä,Í AŽŸ,İ€-Ú,Å[]à~¾,μ,Ü,·B



LMHOSTS ,ì<K'¥



LMHOSTS ,İfKfCfhf%ofCf“

## LMHOSTS ,ì<K'¥

LMHOSTS "à,lfGf"fgfŠ,É,íAŽŸ,ì,æ,æ,È<K'¥,ª"K—p,³,è,Ü,·B



ŠefGf"fgfŠ,íA•ÉX,ìs,É<L"ü,μ,Ü,·B



IP fAfhfCEfX,ðÅ%»,ì—,É<L"ü,μA,»ìCEä,É'í%ž,·,éfRf"fsf...[f^~¼,δ<L"ü,μ,Ü,·B



IP fAfhfCEfX,ÆfRf"fsf...[f^~¼,Æ,ìŠÖ,íA1 ,Â^Èèä,ì<ó""•Ÿš,Ü,½,í^fu,Â<æ∅,è,Ü,·B



fVff[fv•Ÿš (#)  
íA^è"É,ÉAfRf[f"fg,ìæ"ª,ðŽ!,·,ì,ÉŽg,í,è,Ü,·B,½,¾,μA"Á•É,ÈfL[f[fh,ðŽ!,·,±,Æ,à,·,è,Ü,·B

LMHOSTS ,Á,íAŽŸ,ì^è—,ÉŽ!,·fL[f[fh,ðŽg,ì,Ü,·B

### #PRE

fGf"fgfŠ,ìCEä,è,É'Ç%Á,μ,ÄA,»lfGf"fgfŠ,ª~¼'OfLfffbfVf...É, ,ç, ©,Ÿ,ßf[fh,³,è,é,æ,æ,  
É,μ,Ü,·BfftfHf<fg,Á,íAfgf"fgfŠ,ª~¼'OfLfffbfVf...É, ,ç, ©,Ÿ,ßf[fh,³,è,é,±,Æ,í,È,AWINS ,",æ,Ń~  
¼'OAE%ifu[fhflfffXfg,ª~¼'O,ì%ðCE^,ÉŽ,"s,μ,½èè,¾,~%ðí,³,è,Ü,·B#PRE ,íA#INCLUDE  
•Ÿ,ÉCE»,è,éfGf"fgfŠ,É,à•t%Á,·,é•K—v,ª, ,è,Ü,·B#PRE ,ðfGf"fgfŠ,É•t%Á,μ,È,ç,ÆA#INCLUDE  
"à,lfGf"fgfŠ,ì~³Ž<,³,è,Ü,·B

### #DOM:<domain>

fGf"fgfŠ,ìCEä,è,É'Ç%Á,μ,ÄA,±,lfGf"fgfŠ,Æ <domain>  
,É,æ,Á,Äžw'è,³,è,½fhf[fCf",ðŠÖ~A•t, ,Ü,·B,±,ìfL[f[fh,íAfu%ofEfu fT[fxfX,Æf[fOfif"  
fT[fxfX,ªATCP/IP ŠÁ<<,Á,Ç,ì,æ,æ,ÉU,é•,æ, ©,É%œ<¿,μ,Ü,·B#DOM  
fGf"fgfŠ,ð, ,ç, ©,Ÿ,ßf[fh,·,é,É,íA,±,ìs,É #PRE fL[f[fh,à'Ç%Á,·,é•K—v,ª, ,è,Ü,·B

### #INCLUDE <filename>

<filename> ,ÉŽw'è,μ,½ftf@fCf<,ðCEŸð,μACE©,Á, ©,Á,½ftf@fCf<,ðf[fj< ftf@fCf<,Æ"" ,Ÿ,æ,æ,  
,É•èí!,·,é,æ,xfVfXfef€,É<Ÿ,μ,Ü,·B"Ä—p~¼'O•t,~<K'¥ (UNC) ,É,æ,é <filename>  
,ðŽw'è,·,é,ÆAfT[f[fh,ÄW'+ŠÇ—,³,è,Ä,ç,é LMHOSTS ftf@fCf<,ðŽg—p,·,é,±  
,Æ,ª,Á,« ,Ü,·BfT[f[fh,ªf[fj< fu[fhflfffXfg—  
ì^æ,ìŠÖ,É, ,éèè,íAft[f[fh,É'í,·,éf}fbfsf"fo,ðA#INCLUDE  
fZfNfVf#f"à,ìfT[f[fh, fGf"fgfŠ,æ,è'O,É'Ç%Á,·,é•K—v,ª, ,è,Ü,·B,Ü,½A,±  
,ìfT[f[fh, fGf"fgfŠ,ðA, ,ç, ©,Ÿ,ßSmŽÀ,Éf[fh,·,é,½,ß,ÉA#PRE ,à'Ç%Á,μ,Ü,·B

### #BEGIN\_ALTERNATE

•j" ,ì #INCLUDE •Ÿ,ìfOf<[fv,ìšŽnqs,É^ó,ð•t, ,Ü,·B#INCLUDE •Ÿ,ìžÀqs,É 1  
,Á,Ä,à<—CE±,·,é,ÆA,±,ìfOf<[fv'S'ì,ìžÀqs,ª—CE±,μ,Ü,·B

### #END\_ALTERNATE

#INCLUDE fOf<[fv%» ,ì,í,è,ðŽ!,·,½,ß,ÉŽg,ç,Ü,·B

### \0xnn

NetBIOS ~¼,ì't,ì^óü•s%Á"\,É•Ÿš,ðfTf[fg,μ,Ü,·BNetBIOS ~¼,ð"řd^ø—p•,,Á^í,ÝA\0xnn 16  
íi•<L,ðŽg,çA,» ,ì^óü•s%Á"\,É•Ÿš,ì 16 í'l,ðŽw'è,μ,Ü,· (%œ<L,ìžg—p—á,ðžQ[Æ]B,±,ì•<L—  
@,É,æ,èA"Äž~¼,ðŽg—p,μ,Ä,ç,éfjXf^fè fAfVfŠfP[fVf#f",ðAf<[fefBf"fo,³,è,½fgf]  
f[fW,ì't,Á³í,É<@",³,¹,é,±,Æ,ª,Á,« ,Ü,·B,μ, ©,μALAN Manager TCP/IP ,í 16 íiCE^Ž®,ð" FŽ",μ,È,ç  
,ì,ÁA,±,ì<@"\,ðŽg,æèèA%œ^ÉCEÝŠ<« ,ì•úšü,·,é,±,Æ,É,È,è,Ü,·B

, ±, ì 16 □i•\<L-@, Í□A-¼'O, Ì'†, Ì 1 •¶Žš, ¾, ¯, É“K—p, ³, ê, é, ±, Æ, É'□^Ó, μ, Ä,, ¾, ³, ç□B16 •¶Žš, É-ž, ½, È, ç  
NetBIOS -¼, É, Í<ó''•¶Žš, ð'}“ü, μ□A“ÁŽê•¶Žš, ¢-¼'O, Ì□ÁĈĚä (16 "Ô-Ú, Ì•¶Žš) ,É,, é, æ, x, É, μ, Ü, ·□B

ŽŸ, É□A, ±, ê, ç, ÌfL□[f□□[fh, ÌŽg, ç•û, Ì—á, ðŽ!, μ, Ü, ·□B

```
102.54.94.98    localsrv    #PRE
102.54.94.97    trey        #PRE #DOM:networking    #net group's domain controller
102.54.94.102   "appname    \0x14"      #special app server
102.54.94.123   popular     #PRE        #source server
```

```
#BEGIN_ALTERNATE
#INCLUDE \\localsrv\public\lmhosts
#INCLUDE \\trey\public\lmhosts
#END_ALTERNATE
```

, ±, Ì—á, Í□AŽŸ, Ì, æ, x, É“à—e, ðŽ!, μ, Ä, ç, Ü, ·□B



**localsvr** , ¯, æ, Ñ **trey** , Æ, ç, x-¼'O, ÌfT□[fo□[, ¢Žw'è, ³, ê, Ä, ç, Ü, ·□B, μ, ½, ¢, Á, Ä□A□W'†ŠÇ—□, ³, ê, Ä, ç, é  
LMHOSTS ftf@fCf<"à, Ì #INCLUDE •¶, Ä□A, ±, ê, ç, ÌfT□[fo□[-¼, ðĈĚä, ÁŽg, x, ±, Æ, ¢, Ä, «, Ü, ·□B



fT□[fo□[-¼ "appname \0x14" ,É, Í□A15 ĈĚÄ, Ì•¶Žš (<ó''•¶Žš, ðŠÜ, p) , ÌĈĚä, É“ÁŽê•¶Žš, ¢•t  
%ooÁ, ³, ê, Ä, ç, Ü, ·□B, μ, ½, ¢, Á, Ä□A, ±, Ì-¼'O, Í"ñ□d^ø—p•,, Ä^í, ñ, Ä, , è, Ü, ·□B



**popular** , Æ, ç, x-¼'O, ÌfT□[fo□[, ¢□A#PRE fL□[f□□[fh, ÉŠî, Ä, ç, Ä, , ç, ©, ¶, ßf□□[fh, ³, ê, Ü, ·□B





## LMHOSTS ,ÉfŠf,[]fg fT[]fo[],ðŽw'è,.,é

LMHOSTS ftj@fCf<,ÉfRf"fsf...[]f^-¼,Æ IP fAfhfCfX,lf}fbfsf"fo,žw'è,³,è,Ä,ç,è,î[]Af[][]fj< fuf[][]fhfLfffXfg—î^æ,îŠO,ÄfRf"fsf...[]f^-¼,ð%ðCE^,.,é,±,Æ,ä,Ä,«,Ü,·[]B,½,Æ,î,î[]AlientA ,Æ,ç,æ-¼'O,lfRf"fsf...[]f^,ä[]AIP fuf[][]fhfLfffXfg—î^æ,îŠO,É, ,é ServerB ,Æ,ç,æ-¼'O,lfRf"fsf... []f^,ÉfAfNfZfX,ðŽŽ,Ý,Ä,ç,é[]è[]#,ð[][,Ä,Ý,Ü,·[]B,ç,ç,ç,î Windows NT fRf"fsf...[]f^,à[]AMicrosoft TCP/IP ,ð —p,ç,Ä[][]-,µ,Ä, ,é,à,î,Æ,µ,Ü,·[]B

lf}fbfgf[][]fN fNf%oCfAf"fg[]ä,î LMHOSTS ftj@fCf<,ðŽg,æ[]è[]#,î[]AfŠf,[]fg fRf"fsf... []f^,lfCfWfXfgfŠ,ð[]C³,µ,É, ,é,î,É,è,Ü,¹,ñ[]BLMHOSTS ftj@fCf<,ðŠÜ,p<æ—L-¼,î[]A^È%o°,ÉŽ!,.,æ,æ ,É[]AfCfWfXfgfŠ fL[][,É<æ—L-¼,ð'Ç%oÄ,.,é,±,Æ,É,æ,Ä,Ä[]AfT[]fo[][]ä,î Null fZfbjVfj^è—,É'Ç %oÄ,³,è,Ü,·[]B

HKEY\_LOCAL\_MACHINE\System\CurrentControlSet\Services  
\LanManServer\Parameters\NullSessionShares

<<` ,ì b\_fm[][]fh fuf[][]fhfLfffXfg fvf[]fgfRf<,ì%o°,Ä,î[]AlientA ,ç ServerB ,Ö,ì-¼'O[]Æ%oï—v<[][,ÍŽ,"s,µ,Ü,· (f^fCfÉfAfEfg,É,æ,è)[]B,±,è,î[]AServerB ,afŠf,[]fg fTfufjfbfg[]ä,É"z'u,³,è,Ä, ,è[]AlientA ,lfuf[][]fhfLfffXfg —v<[][,É%ož"š,µ,É,ç, ,ç,Ä,·[]B,±,è,ð%ðCE^,.,é,½,ß,É[]A'ä'Ö,ì-¼'O%ðCE^,î•û-@,ä'ñ<Ý,³,è,Ä,ç ,Ü,·[]BWindows NT ,î[]AfRf"fsf...[]f^-¼,Æ IP fAfhfCfX,lf}fbfsf"fo—p,ÉCEÀ'è,³,è,½fLfffbfVf... ,ð•ÜŽ[][,µ,Ä,ç,Ü,·[]B,±,lfLfffbfVf...,î[]AfVfXfef€<N" @Žž,É[]%oŠú%o»,³,è,Ü,·[]BfRf"fsf...[]f^,Ä-¼'O,ð %oðCE^,.,é•K—v,ä<N,±,é,Æ[]AWindows NT ,ì,Ü, ,±,lfLfffbfVf...,ð'²,×[]AfLfffbfVf..."à,ÉŠY"—,.,é-¼'O,ä,É,ç ,Æ[]Afuf[][]fhfLfffXfg-¼'O%ðCE^,ðŽg,ç,Ü,·[]B,±,è,É,àŽ,"s,.,é,Æ[]ALMHOSTS ftj@fCf<,žg,í,è,Ü,·[]B,± ,î[]ÄCEä,î•û-@,É,àŽ,"s,µ,½[]è[]#,î[]A-¼'O,ì%oðCE^,Ä,«, ,[]AfGf%o[] f[]fbfZ[]fW,ä•Ž!,³,è,Ü,·[]B

,±,ì,æ,æ,É-¼'O%ðCE^,î•û[]j,ì, ,ç,° ,Ä[]ALMHOSTS ftj@fCf<,É'½[] ,lf}fbfsf"fo,ð<L'ü,µ,Ä, ,± ,Æ,ä,Ä,«[]A,Ü,Æ,ñ,ÇŽg,í,è,É,tfLfffbfVf...,ð^ÜŽ[][,.,é,½,ß,É'ä—e—É,lfXf^fefBfbfN f[]f,Š,ðŠ,,è"—,Ä,é•K— v,ä, ,è,Ü,¹,ñ[]B-¼'OfLfffbfVf...,É,î[]ALMHOSTS ftj@fCf<,ì #PRE fL[]f[][]fh,ä•t,ç ,½fGf"fgfŠ,¾, ,ä[]AfVfXfef€<N" @Žž,É, ,ç, ,ç,ßf[][]fh,³,è,Ü,·[]B,½,Æ,î,î[]ALMHOSTS ftj@fCf<,ÍŽÝ,ì,æ,æ ,É,É,è,Ü,·[]B

102.54.94.91	accounting	#accounting server
102.54.94.94	payroll	#payroll server
102.54.94.97	stockquote	#PRE #stock quote server
102.54.94.102	printqueue	#print server in Bldg 10

,±,ì—á,Ä,î[]Astockquote ,Æ,ç,æ-¼'O,lfT[]fo[][,É #PRE fL[]f[][]fh,ä•t,ç,Ä,ç,é,ì,Ä[]A,± ,lfT[]fo[] fGf"fgfŠ,ä[]A-¼'OfLfffbfVf...,É, ,ç, ,ç,ßf[][]fh,³,è,Ü,·[]BLMHOSTS ftj@fCf<,lfGf"fgfŠ,î[]AMicrosoft TCP/IP ,ðŽÄ[]s,.,é Windows NT Workstation fRf"fsf...[]f^[]AWindows NT Server fRf"fsf...[]f^[]A,Ü,½,î LAN Manager fT[]fo[][,ð\.,±,Æ,ä,Ä,«,Ü,·[]BLMHOSTS ftj@fCf<"à,ÄfVf %o[]fbfgftfH[]f€,ìŽí—p,ì^á,ç,ð<æ•É,.,é•K—v,ì, ,è,Ü,¹,ñ[]B

'[] : Windows NT f^fo #PRE ,É,æ,è[]ALAN Manager 2.x LMHOSTS ftj@fCf<,Æ,ì %o^ÈCEÝŠ<[][,ð•Ü,Ä,±,Æ,ä,Ä,«[]AWindows NT ,É[]\_ "î[]< ,ä•t%oÄ,³,è,Ü,·[]BLAN Manager ,ì %o°,Ä,î[]AfVf[]f[]fv•¶Žš (#) ,lfRf[]"fg,ð\.,µ,Ü, ,ç,ç[]A,±,è^È[]-,ì•¶Žš,ì,.,x,Ä-³Ž<,³,è,Ü,·[]B^è•û[]A#PRE ,ì Windows NT ,Ä,ì—LCEø,Éf^fo,Ä,·[]B

[]ä,ì—á,Ä,î[]Aaccounting[]Apayroll[]A, ,æ,ñ printqueue ,Æ,ç,æ-¼'O,lfT[]fo[][,ì-¼'O %oðCE^,î[]AfLfffbfVf... fGf"fgfŠ,î[]Æ[]#,äŽ,"s,µ[]Afuf[][]fhfLfffXfg fvf[]fgfRf<,Ä,àfT[]fo[][,ìCEÝø,ÉŽ,"s,µ,½CEä,Ä,ì,ÝŽÄ[]s,³,è,Ü,·[]B, ,ç, ,ç,ßf[][]fh,³,è,Ä,ç,É, ,ç,Ä,½fGf"fgfŠ,ä %oðCE^,³,è,é,Æ[]A,±,lfGf"fgfŠ,lf}fbfsf"fo,ä[]AÄŽg—p,ì,½,ß,É^è'èŠúŠÖfLfffbfVf...,É•ÜŽ[][,³,è,Ü,·[]B



Windows NT ,Á,íA-¼'OfLfffbfVf...,É, ,ç, ©, ¶,ßf[]fh,Á,«,éGf“fgfŠ,ì”,íAffffHf<fg,Á,í 100 ĄĀ,Ā,·B,±  
,ì\$ĄĀ,íA#PRE ,ª•t,ç,Ä,ç,éLfffbfVf...,³,è,È, ©,Á,½fGf“fgfŠ,¾,¯,É“K—p,³,è,Û,·B100  
ĄĀ,ð',,í,éGf“fgfŠ,ðŽw'è,µ,½èè,íAĀ%o,ì 100 ĄĀ,ì #PRE

•t,«fGf“fgfŠ,¾,¯,ª, ,ç, ©, ¶,ßf[]fh,³,è,Û,·B,»,è^È~,ìfGf“fgfŠ,í<N“ @Žž,É,í-³Ž<,³,è,Û,·ªA“ @“í  
%oðĄĀ^,ªŽ,“s,µ,½ĄĀ,ĀfVfXfef€,ª LMHOSTS ftj@fCf<,ð%oðí,·,é,Ā,«%oðĄĀ^,³,è,Û,·B

,Û,½Ā**Anbtstat -R** fRf}f“fh,ðŽg—p,·,è,íA-¼'OfLfffbfVf...,ðĀĀ€”ð,·,é,±,Ā,ª,Ā,«,Û,·B,±,ìfRf}f“fh,íA-  
¼'OfLfffbfVf...,ð<ó,É,µ,Ā, ©,çĀf[]fh,µĀLMHOSTS ftj@fCf<,ðĀĀ“x“Ç,ÝŽæ,èA#PRE

fL[]f[]fh•t,«fGf“fgfŠ,ð'}“ü,µ,Û,·B**nbtstat -R** fRf}f“fh,ðŽg—p,·,é,ĀA“ü—  
í,ÉĄĀ,è,ì, ,éGf“fgfŠ,âfuf[]fhfLffXfg%oðĄĀ^,É—Ą÷,µ,½,½,ß,ÉfLfffbfVf...,É'}“ü,³,è,½-¼'O,È,ÇA, ,ç, ©,  
¶,ßf[]fh,³,è,Ä,ç,éGf“fgfŠ,ðŽæ,èœ, ©ĄĄ³,·,é,±,Ā,ª,Ā,«,Û,·B

#DOM ,ðŽg,Á,ÄfhfCf" fRf"fgfCf" ,ðŽw'è, ,é

LMHOSTS ,aA,à^è"É"l,ÉŽg,i,è,é,ì,íAftf@fCf< fT[fxfX,Æ^óüfT[fxfX,ì,½,ß,ÉfŠf,[]fg  
fT[fo[ ,l^É'u,ð'è,ß,é,½,ß,Ä,·B,µ,©,µ Windows NT ,Ä,íALMHOSTS ,ðf<[fefBf"fo,³,è,½ŠÄ«« ,Ä TCP/IP  
,ðŽÄs,·,éfhfCf" fRf"fgfCf" ,ìCEÿð,É,àŽg,µ,±,Æ,ä,Ä,« ,Ü,·BWindows NT fhfCf" fRf"fgfCf"  
,íAft[[]fU[] fAfjJfE"fg fZfLf...fŠfefB ff[f^fx[]fX,ð·ÜŽç,µA,Ü,½,» ,ì,Ü,© ,lfhfbfgf[]fNŠÖ" AfT[fxfX,ðŠÇ—  
·,µ,Ü,·B'áK-í,È Windows NT fhfCf" ,íA·i[] ,ì IP fTfufhfbfg,É,Ü,½,²,é,±,Æ,à , ,é,ì,ÄAfc[]f[] ,éfhfCf"  
fRf"fgfCf" ,ðCEÿ,ç,É·²—£,³,¹,½,èAfhfCf" fRf"fgfCf" ,© ,çfhfCf" "à,ì,Ü,© ,lfRf"fsf...[]f^ ,ð·²—£  
,³,¹,½,è,·,é,±,Æ,à , ,è,ì,Ü,·B

#DOM fL[]f[]fh,ð LMHOSTS ftf@fCf<"à,ÄŽg—p,·,è,íAWindows NT Workstation fRf"fsf...  
[]f^[]A,Ü,½,íALAN Manager fT[fo[ , ,ç Windows NT fhfCf" fRf"fgfCf" ,ðæ·É,·,é,±  
,Æ,²,Ä,« ,Ü,·B#DOM f^fo,ðŽg—p,·,é,É,íALMHOSTS "à,ì-¼'O,Æ IP fAfhfCfX,lf}fbfsf"fo,ìCEä,ÉA#DOM  
fL[]f[]fh[]Afrf[]A, ,æ,ÑfhfCf" fRf"fgfCf" ,äŽQ%Á,µ,Ä,ç,éfhfCf" ,ð<L"ü,µ,Ü,·BŽÿ,É—  
á,ðŽ,ì,µ,Ü,·B

102.54.94.97 treydc #DOM:treycorp #The treycorp domain controller

' : •p"É,ÉfAfNfzfx,³,è,éfhfCf" fRf"fgfCf" ,íA#DOM f^fo,ìCEä,É #PRE fL[]f[]fh,ð<L"ü,µ,Ü,·  
(LAN Manager fT[fo[ ,à,±,ì LMHOSTS ftf@fCf<,àŽg,µ,è,íA,íA,·,²d—v,Ä,·)B

#DOM fL[]f[]fh,ðŽg,Á,ÄfhfCf" fRf"fgfCf" ,ðŽw'è, ,é,ÆA"ÁŽéfCf" f^[]f[]fbfg fOf<[]fv-¼fLfffbfVf...  
,ÉfGf"fgfS,²Ç%Á,³,è,Ü,·B,±,lfLfffbfVf...,íA[]f[]f[]f< fhfCf" fRf"fgfCf" ,É'í,·,é—  
v<,²Afc" f^[]f[]fbfgf[]fN,É"z·z,³,è,é,ì,ð\$CEÀ,·,é,½,ß,ÉŽg,i,è,Ü,·Bf[]Of" —v<,É,Ç,lfhCf"  
fRf"fgfCf" fAfNfefBfrfefB,²<N,±,é,ÆA,±,ì—v<,í"ÁŽè,ÉfCf" f^[]f[]fbfg fOf<[]fv-¼[]ä,É'—  
,ç,è,Ü,·Bf[]f[]f< IP fuf[]f[]fhLfffxfg—l^æ"à,Ä,íA,±,ì—v<,í 1 %ñ,¾,~—,ç,èA,ç,·,è,© ,lf[]f[]f< fhfCf"  
fRf"fgfCf" ,ÉŽæ,èä,°,ç,è,Ü,·B,µ,© ,µA#DOM ,ðŽg,Á,Ä LMHOSTS ftf@fCf<"à,ÉfhfCf" fRf"fgfCf"  
% ,ðŽw'è,·,é,ÆAMicrosoft TCP/IP ,lfŠf,[]fg fTfufhfbfg[]ä,É"É'u,·,éfhfCf" fRf"fgfCf" ,É,àff[]f^Of%œ  
,ð—p,ç,Ä—v<,ð"l—,µ,Ü,·B

,±,ì,æ,µ,ÉfhfCf" fRf"fgfCf" fAfNfefBfrfefB,ì—á,É,íAfhfCf" fRf"fgfCf" ppf<X (fAfjJfE"fg  
ff[]f^fx[]fX,ì"Šú%» ,ÉŽg—p)[]Afc[]Of" F[]Afc[]X[]fh·íX[]Af}fXf^ fuf%œfU^è—,ì"Šú  
%»[]A, ,æ,Ñ,» ,ì,Ü,© ,lfhCf" ŠÇ—,ÉŠÖ,·,éfAfNfefBfrfefB,², ,è,Ü,·B

·i[] ,lfTfufhfbfg,É,Ü,½,²,éfhfCf" ,É'í,µ,Ä,íALMHOSTS ftf@fCf<,Ä #DOM ,ðŽg,µ,±,Æ,É,æ,èAfhfCf" ,ìd  
—v,Éf[]f[]f[]f,ðf}fbfv,·,é,±,Æ,²,Ä,« ,Ü,·BŽÿ,ÉA,±,lf}fbfsf"fo,É,Ä,ç,Ä,lfKfCfhf%œCf" ,ð,ç,·,Ä,©Ž,ì,µ,Ü,·B



, ,éfhfCf" ,lf[]f[]fo[ ,Ä, ,é Windows NT fRf"fsf...[]f^[]ä,ìŠef[]f[]f< LMHOSTS ftf@fCf<,É,íAfc[]f[]fg  
fTfufhfbfg[]ä,É"É'u,·,èA,±,lfhCf" "à,ì'SfhfCf" fRf"fgfCf" ,É'í,·,é #DOM fGf"fgfS,ð<L"ü,·,é·K—  
v,², ,è,Ü,·B,±,è,É,æ,èAfc[]Of" F[]Afc[]X[]fh·íX[]AZQÆ,É,Ç,²f[]f[]f< fhfCf" ,Ä,·,x,Ä³[]í,É"—  
,« ,Ü,·B,±,ì #DOM fGf"fgfS,íAWindows NT fVfXfef€,ð Windows fhfbfgf[]fN,lfCf" f^[]f[]fbfgf[]fN,ÉŽQ  
%Á,³,¹,è,ì,ÉA'áCEA·K—v,ÉfGf"fgfS,Ä,·B



fobfNfAfbfv fhfCf" fRf"fgfCf" ,Æ,µ,Ä<@"\,Ä,« ,é,·,x,Ä,lfT[]fo[[]ä,lf[]f[]f< LMHOSTS  
ftf@fCf<,É,íAfc[]f[]fS fhfCf" fRf"fgfCf" ,ì-¼'O,Æ IP  
fAfhfCfX,lf}fbfsf"foA, ,æ,Ñ,Ü,© ,ì,·,x,Ä,lfobfNfAfbfv fhfCf" fRf"fgfCf" ,lf}fbfsf"fo,ð<L"ü,·,é·K—  
v,², ,è,Ü,·B,±,è,É,æ,èAfc[]fo[ ,ðfhfCf" fRf"fgfCf" ,  
,Æ,µ,Ä,ì'n^É,ð,Š,³,¹,Ä,èAfhfCf" ,lf[]f[]fo[ ,ÉfT[]fxfX,ð,·,x,Ä'ñ<ÿ,·,é<@"\,É%œç,µ,Ü,¹,ñB



fhfCf" ŠÖ,ÉM—ŠŠÖEW,²"¶ÿ,·,éè,íAfc[]f[]f< LMHOSTS ftf@fCf<,ÉA[]M—Š,³,è,éµ  
,ì,·,x,Ä,lfhCf" ,ì'SfhfCf" fRf"fgfCf" ,ð<L"ü,µ,Ä, ,·K—v,², ,è,Ü,·B



Ž<·²,lf[]f[]f< fhfCf" ,© ,çŽQÆ,µ,½,çfhfCf" ,², ,éè,íAfc[]f[]f< LMHOSTS ftf@fCf<,É,Æ,afŠf,[]fg fhfCf" "à,lfv  
%œCf}fS fhfCf" fRf"fgfCf" ,ì-¼,Æ,» ,ì IP fAfhfCfX,lf}fbfsf"fo,ðAfc[]f[]f< LMHOSTS  
ftf@fCf<,É<L"ü,µ,Ä, ,·K—v,², ,è,Ü,·B,Ü,½Afc[]f[]fS fhfCf" fRf"fgfCf" ,Ö,ì,Š,²Afc[]f[]fg

fhf[]fCf", ,đŽQ[]Æ, ,é<@"\,đ-W, °, È, ç, æ, x, É[]AfofbfNfAfbfv fhf[]fCf" fRf"fgf[][]f%o, à<L"ü, μ, Ä, ", •K—  
v, <sup>a</sup>, , è, Ü, :[]B

fhf[]fCf", ,ì[]", <sup>a</sup> 20 ,É-ž, ½, È, ç[]-<K-í, ©, ç'+<K-í, ìf[]fbfgf[][]fN, Ä, í[]A<x'É, ì LMHOSTS ftf@fCf<, <sup>a</sup> 1  
, Ä'[]Y, , , è, î[]A'É[]í[]Afcf" f^[]f[]fbfgf[][]fNä, ì'Sf[][]fNfXfe[]fVf#f", , , æ, Ñ'SfT[]f[]o[][], ì—v<[], đ-ž, ½, , , ±  
, Æ, <sup>a</sup>, Ä, «, , Ü, , []B, ±, è, đŽÀÆ», , , é, É, í[]AWindows NT •; []»fT[]f[]rfX, đfVfXfef€, ÄŽg, Á, Ä[]Afof[][]fof< LMHOSTS  
, ì"~Šúf[][]f[]f< fRfs[][], đ•ÜŽç, , , é, ©[]A[]W'tŠÇ—[], <sup>3</sup>, è, ½ LMHOSTS ftf@fCf<, đŽg, x•K—v, <sup>a</sup>, , è, Ü, : ([]W'tŠÇ=  
[], <sup>3</sup>, è, ½ LMHOSTS ftf@fCf<, đŽg, x, đŽQ[]Æ)[]B



,ÆA#INCLUDE •¶,Í-³Ž<,³,ê,Û,·B

,±,lfufbfN fCf“fNf<[fh,íAfOf[fof< LMHOSTS ftf@fCf<,ªă,ì 3 ,Â,ìêŠ,ì,ç  
,,ê,©,©,ç“üžè,Â,«A,Ù,©,lfT[fo[ ,ªŽg,í,ê,È,çê¶,É-CE±,μ,Û,·B,ç,,ê,lfT[fo[,à—  
p,Â,«,È,çê¶A,Û,½,í%½,ç,©,ì—R,Â LMHOSTS ftf@fCf<,©fpfX,ª³,μ,,È,çê¶,íAfufbfN  
fCf“fNf<[fh,ÉŽ,“s,μ,½,±,Æ,đŽ!,fCxf“fg,ì<L~^,ªfCxf“fg ffo,É’Ç%Á,³,ê,Û,·B

## FTP fT[fO[f T[fRfX,É,Á,č,Ä

Microsoft FTP fT[fO[f T[fRfX,đŽg,æ,ÆATCP/IP fv[fO[fRf<,Æ Windows NT fRf“fsf...[f^,íAFTP (File Transfer Protocol; ftj@fCf<“]’—fv[fO[fRf<) ,đTf]O[fO,·,éŠf,[]fg fRf“fsf...

[f^,Æ,ìŠÔ,Á‘ŠCEY,Éftj@fCf<,đ“]’—,Á,«,Ü,·BFTP fT[fO[f T[fRfX,íAWindows NT **ftp** fNf%ofCfAf“fg fRf}f“fh,đ,·,x,ÄTf]O[fO,μ,Ä,č,Ü,·BMicrosoft fo[]fWf#f“,Á,Í,È,č FTP fNf%ofCfAf“fg,É,íAMicrosoft FTP fT[fO[f T[fRfX,Á,ÍTf]O[fO,μ,È,čfRf}f“fh,đŽ,Á,à,ì,à, ,è,Ü,·BFTP fT[fO[f T[fRfX,íAf}f<f`fXfæfbfh,ì Win32 fT[fRfX,Æ,μ,ÄŽÁ‘·,³,è,Ä,“ ,èARFC 959 ,“ ,æ,Ñ 1123 ,É‘è<` ,³,è,Ä,č,é—vCE,É€<’,μ,Ä,č,Ü,·BRFC ,íAIETF (Internet Engineering Task Force) ,ìCEöŽ@[]<Æ·¶’ ,Á,·B

FTP fT[fO[f T[fRfX,íAWindows NT ,ìZfLf...fŠfefB f,ff<,Æ“[]ž,³,è,Ä,č,Ü,·BFTP fT[fO[f T[fRfX,ÉÚ± ,·,éft[]fU[] ,íAWindows NT ft[]fU[] fAfjEf“fg,ÉŠì,Ä,č,Ä“F[]Ø,³,èAf[]fU[] fv[]ftj@fCf<,ÉŠì,Ä,č ,ÄfAfNfZfX,đs,č,Ü,·B,μ,½,³,Ä,ÄAFTP ,©,ç—~—p%oÁ“\ ,Éftj@fCf<,“ ,æ,ÑffBfæfNfjgŠ,đ·ÚCèì,Á,« ,é,æ,æAFTP fT[fO[f T[fRfX,í NTFS fp[]fefBfVf#f“,É‘g,Ýž,þ,± ,Æ,đ,“Š©,ß,μ,Ü,·B

ŽŸ,ì€—Ú,É,Á,č,Äà—¾,μ,Ü,·B



[FTP fT\[fO\[f T\[fRfX,đ‘g,Ýž,þ](#)



[FTP fT\[fO\[f T\[fRfX,đ\[\]—,·,é](#)



[FTP fT\[fO\[f fZfLf...fŠfefB,đ\[\]—,·,é](#)



[FTP fT\[fO\[f T\[fRfX,đŠC—\[\] ,·,é](#)



[FTP fT\[fO\[f T\[fRfX,ìÚx,È\[\]—fpf%of\[\]f^](#)

Æx[] : FTP fT[fO[f fv[fO[fRf<,íAf[]fU[] fpfXf[]fh,đff[]f^,ì^Á[]t %o»,đs,í, ,ÉAf[]fbfgf[]fN,É“n,·<@“\,É^È‘¶,μ,Ä,č,Ü,·Bf[]fbfgf[]fN fAfj %ofCfU,đ“đ,ì,½ft[]fU[] ,íA,Ü,© ,ìft[]fU[] ,ìŠf,[]fg fAfjEf“fg fpfXf[]fh,đ“üžè,Á,« ,é%oÁ“\ []<,³ ,è,Ü,·BfZfLf...fŠfefB<@“\ ,ì,È,čf[]fbfgf[]fN,Éf[]Of[]f“ ,·,é,Æ,« ,ÉŽg,æpfXf[]fh,Æ““ ,¶pfXf[]fh,đAWindows NT ,ìf[]Of[]f“ ,ÉŽg,ì,È,č,æ,æ,É,μ,Ä,¾,³,čBWindows NT[]A,“ ,æ,Ñ LAN Manager f[]fbfgf[]fN,Ážg— p,³ ,è,é[]fOf[]f“ ,ì,½,ß,ìAf[]fEf“fg[]·ñ,íAf[]fbfgf[]fN,É’—,ç,è,é‘O,É,Á,È,É^Á[]t%o»,³ ,è,Ü,·B

## FTP fT[f]o[f] fT[f]rfX,đ'g,Ýž,þ

FTP fT[f]o[f] fT[f]rfX,íA[æ,Éà-¾,μ,½fZfLf...fŠfefB[ä,İšëĀ[«,ì,½,ßAŽ©“®“l,É'g,Ýž,Ü,è,é,±,Æ,í,è,Ü,ñBŽŸ,ìžè[#,Á,íA•K—v,ÈfffofCfX,“,æ,ŇfffofCfX fhf %ofCfo,í,·,x,Ä'g,Ýž,Ýí,Ÿ,Á,è,à,ì,Æ,μ,Ä[à-¾,μ,Ä,ç,Ü,·B

FTP fT[f]o[f] fT[f]rfX,đ'g,Ýž,ñ,Á[—,·,é,É,íA[ff]f< fRf“fsf...[f^,ì Administrators fof<[fv,ìf“fo[Æ,μ,ÄfOfif“,μ,È,è,í,È,è,Ü,ñB

## FTP fT[f]o[f] fT[f]rfX,đ'g,Ýž,þ,É,í

1. fRf“fgf[f< fpfif<,ì [fifbfgf[fN] ,đf\_fuf<fNfŠfbfN,μ,Ü,·B
2. [fifbfgf[fN,ìÝ'è) f\_fCfAfO f{fbfNfX,ÁA[fvtfgfEfffA,ì'Ç%Á) f{f^f“,đfNfŠfbfN,μ,ÄA[fifbfgf[fN fvtfgfEfffA,ì'Ç%Á) f\_fCfAfO f{fbfNfX,đ•\ž,ì,μ,Ü,·B
3. [fifbfgf[fN fvtfgfEfffA) ^è—,©,çA[TCPIP fvf[fgfRf<,“,æ,ŇŠÖ~AfRf“f[ff“fg) ,đ'í'đ,μA[±[s] f{f^f“,đfNfŠfbfN,μ,Ü,·B[Windows NT TCP/IP 'g,Ýž,Ýfifvfj#] f\_fCfAfO f{fbfNfX,ÁA[FTP fT[f]o[f] fT[f]rfX) f^fffbfN f{fbfNfX,đfif“,É,μA[±[s] f{f^f“,đfNfŠfbfN,μ,Ü,·B
4. FTP ,ìZfLf...fŠfefB[ä,ì-à'è,É,Á,ç,ÄAft[fU[É,é^Ó,đ'£,·Cex[f]fbfZ[fW,ä•\ž,ì,³,è,Ü,·B[í,ç) f{f^f“,đfNfŠfbfN,μ,ÄAFTP fT[f]o[f] fT[f]rfX,ì'g,Ýž,Ý,đ'±,·,Ü,·B

Windows NT "z•zftf@fCf<,Ö,ìftf< fpfX,ì“ü—í,đ<[ß,éf\_fCfAfO f{fbfNfX,ä•\ž,ì,³,è,Ü,·B“K[Ø,ÈfpfX,đ“ü—í,μA[±[s] f{f^f“,đfNfŠfbfN,μ,Ü,·B

5. fRf“fsf...[f^,É•K—v,Èftf@fCf<,đfRfs[μ,ì,è,é,ÆA[FTP fT[f]rfX) f\_fCfAfO f{fbfNfX,ä•\ž,ì,³,è,Ü,·B

6. FTP fT[f]o[f] fT[f]rfX,đ[—,·,é,É[à-¾,·,éŽè[#,É[),Á,Ä[—,đ'±,·,Ü,·BFTP fT[f]o[f] fT[f]rfX,đ“[®[,³,¹,é,½,ß,É,íA[—[<Æ,đ[s,π•K—v,ä,è,Ü,·B

' : NTFS (Windows NT File System; Windows NT ftf@fCf< fvXfef€) ,đŽg—p,μ,Ä,ç,È,çfffBfXfN fp[fefBfVf#] ,É'í,μ,Ä,íA[Rf“fgf[f< fpfif<,ì [FTP fT[f]o[f] ,đŽg—p,μ,ÄAŠ'È'P,È“Ç,Ýžæ,è,Æ',«ž,Ý,ìZfLf...fŠfefB,đ“K—p,·,é,±,Æ,ä,Ä,«,Ü,·B

**FTP ft[f]fo[f] ft[f]rfX,đ[ ]-.,,é**

FTP ft[f]fo[f] ft[f]rfX f\ftfgfEjFfA,đfRf“fsf...[f^,É'g,Ýž,ň,¼Ā,í[ ]-.,đ[ ]s,κ•K—v,ª, ,è,Û,·[ ]B

**FTP ft[f]fo[f] ft[f]rfX,đ[ ]-.,Û,½,í[ ]Ā[ ]-.,,é,É,í**

1. FTP ft[f]fo[f] ft[f]rfX f\ftfgfEjFfA,đfRf“fsf...[f^,É'g,Ýž,ň,¼Ā,í[ ]-.,đ[ ]s,κ•K—v,ª, ,è,Û,·[ ]B  
f{fbfNfX,ªž©“@“l,É•ž!,³,è,Û,·[ ]B

,Û,½,í[ ]AFTP ft[f]fo[f] ft[f]rfX,í[ ]Ā[ ]-.,đ[ ]s,κ•K—v,ª, ,è,Û,·[ ]B  
,đf\_fuf<fNšfbfN,μ,Û,·[ ]B l'g,Ýž,Û,è,Ā,č,é f\fbfNfX,í[ ]Ā[ ]-.,đ[ ]s,κ•K—v,ª, ,è,Û,·[ ]B  
,đ'í'đ,μ[ ]A[ ]-.,đ[ ]s,κ•K—v,ª, ,è,Û,·[ ]B

2. [FTP ft[f]rfX] f\_fCfAf[ ]fo f{fbfNfX,É[ ]ĀžŸ,ì,æ,κ,É f\fvfVf#“ª•ž!,³,è,Û,·[ ]B [ ]Ā'á[ ]Ú'±[ ]”] [ ]A[fAfCfhf< f^fCf€fAfEfg] [ ]A, ,æ,Ń [fz[ ]f€ fffBfCfNfgš] ,É,í[ ]AfffHf<fg'l,ªž!,³,è,Ā,č,Û,·[ ]B,± ,è,ç,ì'l,đ,».,ì,Û,Ûžg,κ,±,Æ,à[ ]A•K—v,É%ž,¶,Ā•í[ ]X,·,é,±,Æ,à,Ā,«.,Û,·[ ]B

**[ ]Ā'á[ ]Ú'±[ ]”]**

fVfXfefe,É“~žž,É[ ]Ú'±%Ā“\,É FTP ft[f]fo[f] [ ]Ā'á[ ]Ú'±,đžw'è,μ,Û,·[ ]B fffHf<fg'l,í 20 ,Ā[ ]A[ ]Ā'á'l,í 50 ,Ā,·[ ]B0 ,đžw'è,·,é,Æ[ ]A[ ]Ā'á'l,ížw'è,³,è,Û,¹,ň (“~žž,É[ ]Ú'±%Ā“\,É ft[f]fo[f] [ ]Ā'á[ ]Ú'±, ,É,è,Û,·) [ ]B,±,ì[ ]€-Ú,Éžw'è,μ,½[ ]”,ì ft[f]fo[f] [ ]Ā'á[ ]Ú'± FTP ft[f]fo[f] [ ]Ā'á[ ]Ú'±,É“~žž,É f\fofif“ ,μ,Ā,č ,é,Æ,«[ ]A,».,è^É[ ]~ ,É[ ]Ú'±,đžž,Ÿ,é ft[f]fo[f] [ ]Ā'á[ ]Ú'±,É,í[ ]AšC—žž,ª'è< ,μ,½ f\fbfZ[ ]fW,ª•\ ž!,³,è,Û,· [ ]B fffXf^f€ f\fbfZ[ ]fW,đ'è< ,·,é•ú-@,É,Ā,č,Ā,í [ ]AFTP ft[f]fo[f] ft[f]rfX,ì[ ]Ú'±x,É [ ]-fpf %f [ ]f^,đžQ[ ]Æ,μ,Ā,¾,³,č [ ]B

**[fAfCfhf< f^fCf€fAfEfg]**

fAfNfefBfu,Ā,È,č ft[f]fo[f] [ ]Ā'á[ ]Ú'±,μ,Ā,č ,ç,è,éžžšŌ,đ•ª'P^É,Āžw'è,μ,Û,· [ ]B fffHf<fg'l,í 10 •ª,Ā,· [ ]B [ ]Ā'á'l,í 60 •ª,Ā,· [ ]B0 ,đžw'è,·,é,Æ[ ]A ft[f]fo[f] [ ]Ā'á[ ]Ú'±,ªž©“@“l,É[ ]Ø'f,³,è,é,±,Æ,í , ,è,Û,¹,ň [ ]B

**[fz[ ]f€ fffBfCfNfgš]**

ft[f]fo[f] [ ]Ā'á[ ]Ú'±,šúfffBfCfNfgš,đžw'è,μ,Û,· [ ]B

**[“½-¼[ ]Ú'±,đ<-%Ā,·,é]**

**anonymous** ,Æ,č,xf ft[f]fo[f] [ ]Ā'á[ ]Ú'±,đžg—p,μ,Ā FTP ft[f]fo[f] [ ]Ā'á[ ]Ú'±,Ā,«.,Û,· [ ]B fpfXf [ ]fh,í•K— v, ,è,Û,¹,ň,ª[ ]A fpfXf [ ]fh,ì'á,í,è,É ft[f]fo[f] [ ]Ā'á[ ]Ú'±, fAfHfCfX,ì“ü—í,đ<[ ]B,é f\fbfZ[ ]fW,ª•\ ž!,³,è,Û,· [ ]B fffHf<fg,Ā,í [ ]A“½-¼[ ]Ú'±,í<-,³,è,Ā,č,Û,¹,ň [ ]B FTP ft[f]fo[f] [ ]Ā'á[ ]Ú'±,í [ ]A **anonymous** ,Æ,č,κ- ¼'0,ì Windows NT ft[f]fo[f] [ ]Ā'á[ ]Ú'±, fAfjEj“fg,ížg—p,Ā,«.,È,č,±,Æ,É' [ ]^Ó,μ,Ā,¾,³,č [ ]B ft[f]fo[f] [ ]Ā'á[ ]Ú'± **anonymous** ,í [ ]A“½-¼ f\fofif“<@“\—p,É [ ]AFTP ft[f]fo[f] [ ]Ā'á[ ]Ú'±,É—\-ň,³,è,Ā,č,Û,· [ ]B ft[f]fo[f] [ ]Ā'á[ ]Ú'± **anonymous** ,đžg,Ā,Ā f\fofif“ ,·,é ft[f]fo[f] [ ]Ā'á[ ]Ú'±,É,í [ ]A“½-¼ f\fofif“—p,É FTP ft[f]fo[f] [ ]Ā'á[ ]Ú'± [ ]-.,³,è,½ fAfNfZfXCE ,ª—^ ,ì,ç,è,Û,· [ ]B

**[ft[f]fo[f] [ ]Ā'á[ ]Ú'±]**

**anonymous** ,đžg,Ā,Ā f\fofif“ ,μ,½ FTP ft[f]fo[f] [ ]Ā'á[ ]Ú'±, f\fofif“ [ ]Ā'á[ ]Ú'±, fAfjEj“fg,đžg— p, ,é,©,đžw'è,μ,Û,· [ ]B“½-¼ FTP ft[f]fo[f] [ ]Ā'á[ ]Ú'±, fAfNfZfXCE ,í [ ]A,±,±,Āžw'è,μ,½ f\fofif“ ft[f]fo[f] [ ]Ā'á[ ]Ú'± fAfjEj“fg, fAfNfZfXCE ,Æ“ ,¶,É,È,è,Û,· [ ]B fffHf<fg,í [ ]A•W [ ]€,ì Guest fVfXfefe fAfjEj“fg,Ā,· [ ]B

**[fpfXf [ ]fh]**

[ft[f]fo[f] [ ]Ā'á[ ]Ú'±] f{fbfNfX,Āžw'è,³,è,½ ft[f]fo[f] [ ]Ā'á[ ]Ú'±, fAfjEj“fg—p,É fpfXf [ ]fh,đžw'è,μ,Û,· [ ]B



[“½-¼Ú±,ì,Ý,ð<-‰Â,·,é]

ft[fU[-¼ anonymous ,¾, ¯,²fAfNfZfX,ð<-‰Â,³,è,Ü,·BFTP fpfXf[fh,Í^Ä+‰»³,è,Ä,ç,È,ç  
,ì,ÄAf[fU[«»è,¼,è,ìft[fU[-¼,ÆfpfXf[fh,ðŽg—p,μ,ÄfOfIf“,·,é,ì,ð”ð,¯,½,çê±,íA,±  
,ìfVfVf“,í-ð,É—š,¿,Ü,·B,½,¾,μAf[fU[,Í^S^öA“½-¼fAfJfEf“fg,Ä`è`³,è,½“¯,¶fAfNfZfXCE ,ðŽ  
,Ä,±,Æ,É,È,è,Ü,·BfftfHf<fg,Á,íA,±,ìfVfVf“,ìft,É,È,Ä,Ä,ç,Ü,·BWindows NT  
ft[fU[ fAfJfEf“fg,ðŽg,Á,ÄAf[fU[.²Ú±,·,×,«,Á,È,çê±,íA,±,ìfVfVf“,ðf“,É,μ,Ä,¾,¾,çB

3. [OK] f{f^f“,ðfNfŠfbfN,μ,Ä [FTP ft[frfX] f\_fCfAfO f{fbfNfX,ð•Ä,¶A[flfbfgfN,ìÝ`è] f\_fCfAfO f{fbfNfX,É-ß,è,Ü,·B

4. FTP ft[fo[ ft[frfX,ìŠî-{"I,È'g,Ýž,Ý,¨,æ,Ñ\-,ðŠ®-¹,·,é,É,íA[OK] f{f^f“,ðfNfŠfbfN,μ,Ü,·B

•ìX“à—e,ð—LCEø,É,·,é,É,íAfrf“fsf...[f^,ðÄ<N“® ,μ,È,¯,è,Í,È,ç,È,ç,±,Æ,ð'm,ç,¹,éfbfZ[fW,²\  
Ž,³,è,Ü,·B,½,¾,μAfrf“fsf...[f^,ðÄ<N“® ,·,é•K—v,Í, ,è,Ü,¹,ñB‰,ß,Ä FTP  
ft[fo[,ð'g,Ýž,þê±,Ä, ,è,íAfrf“fgf[f< fpf<,ð-¹,μAÄ“x<N“® ,·,é,ÆAfrf“fgf[f< fpf<,É [FTP  
ft[fo[[] fAfCfRf“,²\Ž,³,è,Ü,·BFTP ft[fo[ ft[frfX,ðÄ\  
\-,μ,½,¾,¯,Á, ,è,íA,»],ft[frfX,ðÄŠ],·,é,¾,¯,Á•ìX“à—e,²—LCEø,É,È,è,Ü,·B

' : FTP ft[fo[ ft[frfX,ð‰,ß,Ä'g,Ýž,þ,Æ,«,íAFTP ft[fo[ fZfL...fŠfefB,ð\-,·,é,Äà-  
¾,·,éžê±,É],Á,ÄAfrf“fsf...[f^ã,ìf{fŠ...[f€,ÉfAfNfZfX,·,éft[fU[,ÉÍ,·,éZfL...fŠfefB,ì\  
\-,àŠ®-¹,·,é•K—v,², ,è,Ü,·B

**FTP fT[fO[f ZfLf...fŠfefB,đ\Ń,·,é**

**FTP fT[fO[f ZfLf...fŠfefB,đ\Ń,·,é,É,í**

1. FTP fT[fO[f,ì'g,ÝŃž,Ý,đŠ@—<sup>1</sup>,μ,½CEă,ĀAfrf“fgf[f< fpfj<,đ<N“@,μA[FTP fT[fO[f],đf\_fuf<fNfŠfbfN,μ,Ü,·BWindows NT Server ,ìft[fU[f,íAFT[fO[f f}f!fWff,ì [FTP] fffj...[,đŽg—p,·,é,±,Æ,à,Ā,«,Ü,·B[FTP fT[fU[f fZfbfVfj“] f\_fCfAfO f{fbfNfX,â\Ž,³,é,Ü,·B

2. [fZfLf...fŠfefB] f{f^f“,đfNfŠfbfN,μ,Ü,·B[FTP fT[fO[f fZfLf...fŠfefB] f\_fCfAfO f{fbfNfX,â\Ž,³,é,Ü,·B

3. [fp[fefBfVfj“] f{fbfNfX,ĀA fZfLf...fŠfefB,đŃ'è,μ,½,tfhf %ofCfu•ŃŽš,đ'ì'đ,μ,Ü,·BŽŸ,ÉA'ì'đ,μ,½fp[fefBfVfj“,Ā•K—v,ÈfZfLf...fŠfefB,É %ož,Ń,ĀA[“Ç,ÝŽæ,è,đ<-‰Ā] f fFfbfN f{fbfNfX,Ü,½,í [Ń',«Ńž,Ý,đ<-‰Ā] f fFfbfN f{fbfNfX (,Ü,½,í,»,ì —¼•ù) ,đfj“,É,μ,Ü,·B

Šefp[fefBfVfj“,É'í,μ,ĀA,±,ìŽèŃž,đCE],è•Ô,μ,Ü,·B

,±,é,ç,ìfAfNfZfXCE ,ìŃ'è,íAFAT (ftf@fCf< fAfP[fVfj“ fe[fuf<) fp[fefBfVfj“, ,æ,Ń HPFS (fnfC fpftfH[f]f“fX ftf@fCf< fVfXfef€) fp[fefBfVfj“Ńă,ì,·,x,Ā,ìftf@fCf<,ÉŃì—p,μ,Ü,·BNTFS fp[fefBfVfj“Ńă,Ā,íA,±,ì<@“\,đŽg,Ā,ĀA“Ç,ÝŽæ,èCE ,Ü,½,íŃ',«Ńž,ÝCE (,Ü,½,í,»,ì—¼•ù) ,đfp[fefBfVfj““S'ì,ĀŽæ,èœ,,±,Æ,â,Ā,«,Ü,·B









4. fp[fefBfVfj“,ìfAfNfZfX,ÉŠÖ,·,éfZfLf...fŠfefB,ìŃ'è,đŠ@—<sup>1</sup>,μ,½,çA[OK] f{f^f“,đfNfŠfbfN,μ,Ü,·B

•ìX“à—e,ì'¼,ž,É—LCEø,É,È,è,Ü,·B,±,é,Ā FTP fT[fO[f fT[frfX,đŠ]Žn,·,é€“ö,â@,ç,Ü,μ,½B

## FTP fT[fO[fT[fRfX,đŠÇ—,.,é

ŕ%Šú,ì'g,Ýŕž,Ý,Š—<sup>1</sup>,μ,½Āä,íAfrf“fsf...[f^,“N”@,.,é,½,Ń,ÉAFTP  
fT[fO[fT[fRfX,ÍŽ©“@“l,ÉfofbfNfOf%ofEf“fh,ĀŠjŽn,<sup>3</sup>,è,Ü,·BWindows NT frf“fsf...[f^Ā,Ā FTP  
fT[fO[fT[fRfX,ŽÀŕs,<sup>3</sup>,è,Ā,ç,éŠŌ,ÉAfŠf,ŕfg frf“fsf...[f^,í FTP  
fZfbfVfŕf“,đŠjŽn,Ā,«,Ü,·B,½,¾,μAfŠf,ŕfg frf“fsf...[f^,“,æ,Ń Windows NT frf“fsf...[f^,ì—¼•û,Ā  
TCP/IP fvŕfgfRf<,ŽÀŕs,<sup>3</sup>,è,Ā,ç,È,̄,è,î,È,è,Ü,<sup>1</sup>,ŕŕB

fŠf,ŕfg fT[fUŕ,íAFTP fT[fO[fŕ,ìAŕfEf“fg,âAFTP fT[fO[fŕ,ìfhŕfCf“,Ü,½,íM—Š,<sup>3</sup>,è,Ā,ç,éfhŕfCf“  
(Windows NT Server ,ì,Ý) ,ìAŕfEf“fg,đŽg,Ā,Ā FTP fT[fO[fŕ,Éŕŕ'±,.,é,±,Æ,<sup>a</sup>,Ā,«,Ü,·B,Ü,½A“½-  
¼fŕfOŕf“,đ<-%Ā,.,é,æ,ŕ,É FTP fT[fO[fŕ,ŕfX,<sup>a</sup>ŕŕ,<sup>3</sup>,è,Ā,ç,éêŕŕ,íA**anonymous**  
fAŕfEf“fg,đŽg,Ā,Āŕŕ'±,.,é,±,Æ,à,Ā,«,Ü,·B

-  [FTP fT\[fO\[fT\[fRfX,đŠjŽn,Ü,½,ì'âž~,.,é](#)
-  [frf}f“fh fvŕf“fvfg,Ā FTP frf}f“fh,đŽg—p,.,é](#)
-  [fT\[fUŕ,đŠÇ—,.,é](#)
-  [FTP fT\[fO\[fŕ,ÆfT\[fUŕ, fAfNfZfX,đŕŠĀä,.,é](#)
-  [fffBfĀfNfŕfŠ,ÉfRfŕf“fg,đ•t,̄,.,é](#)
-  [fffBfĀfNfŕfŠ^è——ĀŽ@,đ•ìŕX,.,é](#)
-  [<N”@fŕfbfZŕ\[fW,Æŕŕ—<sup>1</sup>fŕfbfZŕ\[fW,đŕfXf^f}fCfY,.,é](#)
-  [FTP ŕŕ'±,ìfŕfO,đŽûŕW,.,é](#)



**fRf}f“fh fvf□f“fvfg,Å FTP fRf}f“fh,ðŽg—p,·,é**

FTP fT□[fxfX,ð'g,Ýž,þ,Æ□Afrf}f“fh fvf□f“fvfg,ÅŽg—p,Å,«,é **ftp** fRf}f“fh  
fZfbfg,ªŽ©“@“l,É'g,Ýž,Ü,ê,Ü,·□B,±,ê,ç,ìfrf}f“fh,ì,Ü,Æ,ß,É,Å,ç,Ä,í□A□ufRf}f“fh fŠftf@fÇf“fX□v,ì **ftp**  
ì□€—Ú,ðŽQ□Æ,μ,Ä,,¾,¾,ç□B

**ftp fRf}f“fh,ìfwf<fv,ð•\Žì,·,é,É,í**

1. fvf□fOf%of€ f}f□[fWff fOf<□[fv,Å□A[Windows NT fwf<fv] fAfCfRf“ ,ðf\_fuf<fNfŠfbfN,μ,Ü,·□B
2. [Windows NT ,ìfwf<fv] f\_fCfAf□fO,Å□A[frf}f“fh fŠftf@fÇf“fX] ,ðf\_fuf<fNfŠfbfN,μ,Ü,·□B
3. [frf}f“fh] fEfBf“fhfE,Å□A[ftp fRf}f“fh] ,ðfNfŠfbfN,μ,Ü,·□B
4. [frf}f“fh fŠftf@fÇf“fX] fEfBf“fhfE,Å **ftp** fRf}f“fh-¾,ðfNfŠfbfN,·,é,Æ□AŠefRf}f“fh,ì□à-¾,Æ□A□\  
•¶,·,æ,Ñfpf%of□□[f^,ì'è<` ,ð•\Žì,¾,è,Ü,·□B

ft[]fU[],đŠÇ—[],·,é

FTP ft[]fo[],ÉÚ'±,μ,Ä,ç,éft[]fU[],đŠÇ—[],μAFTP ft[]fo[][ä,ìŠef{fŠf...[]f€,ìfZfLf...  
fŠfefB,đŸ'è,·,é,É,íAfrf"fgf[]f< fpflf<,ì [FTP ft[]fo[]] ,đŽg,ç,Ü,·BWindows NT Server frf"fsf...  
[]f^[]ä,Ä,ìŠÇ—[],ª•Ö—~,È,æ,π,ÉAft[]fo[] f}f[]fwff,ì [FTP] f[]ff...[],ì [FTP ft[]frfX]  
frf}f"fh,đ'ì,ñ,Ä,àAfrf"fgf[]f< fpflf<,ìè[]±,Æ"—,¶f\_cfAft[]fo f{fbfNfX,ª•\Žì,ª,è,Ü,·B

FTP ft[]fo[],đŠÇ—[],·,é,É,íAAdministrators foj<[]fv,ìf[]"fo[][,Æ,μ,Äf[]Ofif",μ,È,~,é,î,È,è,Ü,¹,ñB

[FTP ft[]fU[] fZfbfVf#f"] f\_cfAft[]fo f{fbfNfX,ì [Ú'±ft[]fU[]] f{fbfNfX,ÉAÚ'±,μ,Ä,ç,éft[]fU[],ì-  
¼'O[]AfvfXfef€,ì IP fAfhfCEfX[]A, ",æ,ÑÚ'±CEp'±ŽžŠÖ,ª•\Žì,ª,è,Ü,·Bft[]fU[][-¼,ª anonymous  
,đŽg,Á,Äf[]Ofif",μ,Ä,ç,éft[]fU[],É,Ä,ç,Ä,íAft[]Ofif",μ,½,Æ,«,ÉfpfXf[]fh,Æ,μ,Ä"ü—í,μ,½ft[]fU[][-¼,ª•  
Žì,ª,è,Ü,·Bft[]fU[][-¼,Éf[]f< fzfXfg-¼,ªŠÜ,Ü,è,Ä,ç,éè[]±,í (ernesta@trey-research.com ,ì,æ,π  
,É)Aft[]fU[][-¼ (ernesta) ,¾,~,ª•\Žì,ª,è,Ü,·B"½-¼Ú'±ft[]fU[],ìft[]fU[] fAfcfrf",É,í<^â•, (?),ª•t,ç  
,Ä,ç,Ü,·BWindows NT fZfLf...fŠfefB,É,æ,Á,Ä" F[]Ø,ª,è,Ä,ç,éft[]fU[],ìfAfcfrf",É,íA<^â•, ,ì•t,«,Ü,¹,ñB

FTP ft[]fo[],Ä,íA[]ø'f] f{f^f",đŽg—p,μ,ÄAft[]fU[],đ 1 [],,ÄA,Ü,½,í'S^øø'f,·,é,±  
,Æ,ª,Ä,«,Ü,·B[]ø'f,ª,è,éft[]fU[],ÉCEx[]í,ª•\Žì,ª,è,Ü,¹,ñB

FTP ft[]fo[],íAft[]fU[],ªÚ'±,·,é,Æft[]fU[][-¼,đ•\Žì,μ,Ü,·,ªAft[]fU[],ªÚ'±  
,đøø'f,μ,½,èÚ'±ŠúŠÖ,ªCEo%oß,μ,Ä,à•\Žì,đX[]V,μ,Ü,¹,ñB[]A[]V,ì[]•ñ,É[]X[]V]  
f{f^f",đfNfŠfbfN,·,é,Æ[]A•\Žì,ª[]X[]V,ª,è[]ACE»[]ÝÚ'±'t,ìft[]fU[],¾,~,ª•\Žì,ª,è,Ü,·B

[fZfLf...fŠfefB] f{f^f",đfNfŠfbfN,·,é,Æ[]A[FTP ft[]fo[] fZfLf...fŠfefB] f\_cfAft[]fo f{fbfNfX,ª•\  
Žì,ª,è,Ü,·BFTP ft[]fo[] fZfLf...fŠfefB,đ[]\[]-,·,é,Ä[]à-¾,·,é,æ,π,É[]A,±,ìf\_cfAft[]fo f{fbfNfX,Ä,íAFTP  
ft[]fo[][ä,ìŠef[]f[]fBfVf#f",É'í,·,é"Ç,ÝŽæ,èfAfNfZfXCE ,",æ,Ñ",«ž,ÝfAfNfZfXCE ,đŸ'è,Ä,«,Ü,·BFTP  
ft[]fU[],ÉfAfNfZfX,ª,¹,½,çŠef[]f[]fBfVf#f",²,Æ,É[]AfAfNfZfXCE ,đŸ'è,·,é•K—v,ª, ,è,Ü,·Bfp[]f[]fBfVf#f"  
fpf%of[]f^,đŸ'è,μ,È,ç,Æ[]A,Ç,ìft[]fU[],àftf@fCf<,ÉfAfNfZfX,·,é,±  
,Æ,í,Ä,«,Ü,¹,ñBfp[]f[]fBfVf#f",ª[]ANTFS ,È,Ç,ì^À'S,Éftf@fCf< fvfxfef€,đŽg—p,μ,Ä,ç,éè[]±,íAftf@fCf<  
fvfxfef€,ì[]s[]EÀ,à",«,Ü,·B

ft[]fU[],ª Windows NT fAfffEf"fg,đŽg,Á,Äf[]Ofif",·,éè[]±,íAFTP ft[]fo[] fp[]f[]fBfVf#f",ìfZfLf...fŠfefB,É  
%oÁ,ì,Ä[]A,»,ìfAfffEf"fg,ìfAfNfZfXCE EÀ,à",«,Ü,·B

## FTP fT[fO[f,Æft[fU[f fAfNfZfX,ð[sCEä,·,é

fifbfgf[fNŠÇ—žÒ,íAFTP fT[fO[f\N-•i",ì,æ,ì,ç,,Á,©,ð[sCEä,·,é,±,Æ,ª,Å,«,·B,½,Æ,ì,îA,±, ìží,ì·i",É [A'âU'±"] ,ª, ,è,Ü,·B,±,ì·i",íAfRf"fgf[f< fpf|f<,ì [fifbfgf[fN] ,ðžg,Á,ÄA0 ,©,ç 50 ,Ü,Å,ì"í'í,ÅY'è,·,é,±,Æ,ª,Å,«,Ü,·B1 ,©,ç 50 ,Ü,Å,ì'í,ðY'è,·,é,ÆA·Ä—ñ,µ,Ä ("~Žž,É) Šm—š,Å,«,é FTP fZfbfVfj",ì",íŽw'è,µ,½'l,É[sCEÀ,³,è,Ü,·B0 ,ðžw'è,·,é,ÆAfVfXfef€,ªf[f,š,ðžg,ç%È,½,·,Ü,ÅAFTP fT[fO[f,É'í,µ,ÄŠm—š,Å,«,éU'±,ì",ÉäCEÀ,í,È,,È,è,Ü,·B

A'â·Ä—ñU'±",É'B,µ,½,Æ,«·žì,³,è,éjXf^f€ fbfZ[fW,ðžw'è,·,é,± ,Æ,ª,Å,«,Ü,·BfbfZ[fW,ðžw'è,·,é,É,íAfCfWfXfgfš,ì **MaxClientsMessage** ,ÉV,µ,çfbfZ[fW,ð"ü— í,µ,Ü,·B,±,è,É,Å,ç,Ä,íAFTP fT[fO[f fT[fX.ìÚx.È\→fpf%ff[f^,ðžQÆ,µ,Ä,,¾,¾,çB

**ffBfCfNfgfŠ,ÉfRf“fg,đ•t,̄,é**

FTP ft□[fU□[.l,½,β,É□Aft□[fo□[□ã,ì“Á’è,ìffBfCfNfgfŠ,ì“à—e,đ’m,ç,¹,½,ç□é□‡,í□Aft□[fU□[.É•\  
Ž,³,é,é□î•ñ,ìfRf□“fg (annotation) ,đ•t,̄,éffBfCfNfgfŠ,É□A~FTPSVC~.CKM ,Æ,ç,‡-  
¼’O,ìftf@fCf<,đ□□□,μ,Û,·□B’É□í□A,±,ìftf@fCf<,í□AfffBfCfNfgfŠ,đ^ê—,μ,Ä,à•Ž,³,é,È,ç,æ,‡,É□A  
%B,μftf@fCf<,É,μ,Û,·□B%B,μ’@□«,É,·,é,É,í□Aftf@fCf< f}f□[fWff,đŽg—p,·,é,©□Afrf}f“fh  
fvf□“fvfg,Ä□Afrf}f“fh **attrib +h ~ftpsvc~.ckm** ,đ“ü—í,μ,Û,·□B

ffBfCfNfgfŠ,ìfRf□“fg,ì•Ž!,í□Ackm ,Æ,ç,‡’g,Ý□ž,Ý,ì□AftfCfG“Á—L,ìfRf}f“fh,đŽg,Á,Ä□AŠeFTP  
ft□[fU□[.²,Æ,Éfif“ ,Æfift,đ□Ø,è’Ö,ì,é,±,Æ,ª,Ä,«,Û,·□B’ã”¼,ì FTP fNf%ofCfAf“fgŽÀ’• (Windows NT FTP fNf  
%ofCfAf“fg,đŠÜ,þ) ,Ä,í□Afrf}f“fh fvf□“fvfg,É **quote site ckm** ,ì,æ,‡,ÉfRf}f“fh,đ“ü—  
í,μ,Äfif“ ,Æfift,đ□Ø,è’Ö,ì,Û,·□B

fCfWfXfgfŠ“à,ì **AnnotateDirectories** ,É’l,đ□Ý’è,·,é,Æ□AfffBfCfNfgfŠ  
fRf□“fg,ìffftfHf<fg“@□ì,đ□Ý’è,Ä,«,Û,·□B,±,é,É,Ä,ç,Ä,í□AFTP ft□[fo□[ ft□[frfX,ì□Ú□x,È□□□→fpf  
%of□□[f^,đŽQ□Æ,μ,Ä,,¾,³,ç□B



ffffBfCEfNfgfŠ^ê——CE`Ž®,đ•iX,.,é

FTP fNf%ofCfAf“fg f\ftfgfEfFfA,ì‘†,É,íAfffBfCEfNfgfŠ^ê——í•ň,ìCE`Ž®,ÉŠì,Ä,ç,Ä%¼‘è,đ—  
§,Ä,é,à,ì,à, ,è,Ü,·BWindows NT FTP fT[f]o[f],íAUNIX fVfXfef€,É—pŽ—,μ,½ffffBfCEfNfgfŠ^ê——,ª•K—  
v,ÈfNf%ofCfAf“fg f\ftfgfEfFfA,É, ,é‘ö“x\_“î,É‘í%ž,μ,Ü,·Bft[f]U[f],íAfffBfCEfNfgfŠ^ê——  
CE`Ž®,đAfrf}f“fh **dirstyle** ,đŽg,Á,Ä MS-DOS fXf^fCf< (ffffHf<fg) ,Æ UNIX fXf^fCf<,ìŠÔ,Ä∅,è‘Ö,ì,é,±  
,Æ,ª,Ä,«,Ü,·B“å”¼,ì FTP fNf%ofCfAf“fgŽÀ’• (Windows NT FTP fNf%ofCfAf“fg,đŠÜ,p)  
,Ä,íAft[f]U[f],íRf}f“fh fvf“fvfg,É **quote site dirstyle** ,Æ,ç,Ä,½Rf}f“fh,đ“ü—í,μ,Ä^ê——  
CE`Ž®,đ∅,è‘Ö,ì,Ü,·B

fCEfWfXfgfŠ“à,ì **MsDosDirOutput** ,É‘ì,đY‘è,.,é,ÆAfffBfCEfNfgfŠ^ê——CE`Ž®,ìffffHf<fg  
fXf^fCf<,đY‘è,.,é,±,Æ,ª,Ä,«,Ü,·B,±,è,É,Ä,ç,Ä,íAFTP fT[f]o[f] fT[f]rX,ìÚx,È∅-fpf  
%f[f^,đŽQÆ,μ,Ä,,¾,¾,¾,çB

<N" @fbfZ[fW,ÆI—<sup>1</sup>fbfZ[fW,ðjXf^f}fCY,·,é

fCfWfXfgfŠ"à,ì **GreetingMessage** ,",æ,Ñ **ExitMessage** ,ì'ì,ð'Y'è,·,é,ÆA<N" @fbfZ[fW,·,æ,ÑI—  
<sup>1</sup>fbfZ[fW,ðjXf^f}fCY,·,é,±,Æ,<sup>a</sup>,Å,«,Ü,·B,±,è,É,Â,ç,Ä,íAFTP fT[fo[fT[frfX.ìÚx,É\—fpf  
%f[f, ðŽQÆ,μ,Ä,,<sup>3</sup>/<sub>4</sub>,<sup>3</sup>,çBfftfHf<fg,Å,íA,±  
,è,ç,ì'l,ìGf"fgfŠ,ìfCfWfXfgfŠ,É,íŠÜ,Ü,è,Ü,<sup>1</sup>,ñ,ì,ÅAfbfZ[fW feLfxfg,ðjXf^f}fCY,·,é,É,í,±  
,è,ç,ì'l,ìGf"fgfŠ,ð'Ç%Å,·,é•K—v,<sup>a</sup>, ,è,Ü,·B

<N" @fbfZ[fW,·,æ,ÑI—<sup>1</sup>fbfZ[fW,íAFTP fT[fo[,ÉÚ'±,μ,<sup>1</sup>/<sub>2</sub>,Æ,«,âAFTP  
fT[fo[, ©,çØ'f,μ,<sup>1</sup>/<sub>2</sub>,Æ,«ft[fU[,É'—M,<sup>3</sup>,è,Ü,·BjXf^f}fCY  
fbfZ[fW,ðì—,·,é,Æ,«A•i"□s,É"n,éfZ[fW,ð'Ç%Å,·,é,±,Æ,à,Å,«,Ü,·B

**FTP Ú±,lfO,žŮW,·,é**

fCfWfXfgfŠ“à,ì **LogAnonymous** , ,æ,Ñ **LogNonAnonymous** ,ì'l,đÝè,·,é,ÆAÚ±,³,ê,½ FTP  
fZfbfVfjf“ ,lfO,đAfvfXfef€ fCxf“fg fO,ÉŽŮW,·,é,±,Æ,ª,Ā,«,Ü,·B,±,é,É,Ā,č,Ā,ÍAFTP  
fT[fO[fT[fX,ìÚx,ÈN-fpf%ff[f, žQÆ,μ,Ā,,¾,¾,čBfftfHf<fg,Ā,ÍA,±  
,é,ç,ì'l,lfGf“fgfŠ,lfCfWfXfgfŠ,É,ÍŠÜ,Ü,é,Ā,č,Ü,¹,ñ,ì,ĀA“íÚ±fO,žŮW,·,é,É,Í,±,é,ç,ì'l,lfGf“fgfŠ,đ'Ç  
%oĀ,·,é•K—v,ª, ,è,Ü,·B

FTP fT[fO[f,ÉÚ±,μ,Ā,č,é“½-¼ft[fU[f, ,æ,Ñ”ñ“½-¼ft[fU[f,É'í,μ,ĀAfcxf“fg fO  
fGf“fgfŠ,đì-,·,é,©,Ç,κ,©,žw'è,·,é,±,Æ,ª,Ā,«,Ü,·Bfcxf“fg frf...[fA,žg,κ,ÆAfvfXfef€ fCxf“fg  
fO“à,lfGf“fgfŠ,đ·Žì,·,é,±,Æ,ª,Ā,«,Ü,·B

## FTP fT[fO[f T[fRfX,ìÚx,È\~fPf%o[f^

,±,±,Á,íAFTP fT[fO[f T[fRfX,ì" @ì,É%e<ç,·,é\~fPf%o[f^,ì,±,ìAfCfWfXfgfŠ  
fGffBf^,ðŽg,Á,Ä,μ,©C³,Á,«,É,ç,à,ì,É,Á,ç,Äà-¾,μ,Ü,·BfPf%o[f^,ì,δC³,μ,½CEäAOC³"à—e,ð—  
LCEø,É,·,é,É,íAFTP fT[fO[f T[fRfX,ðÄŠ)Žn,·,é•K—v,ª, ,è,Ü,·B

CEx: fCfWfXfgfŠ fGffBf^,ðŽg,Á,ÄfCfWfXfgfŠ,É•s³,É•ìX,ð%Á,ì,½è#AWindows NT  
,í¹,ð,ð"í,é,©AZg—p•s"\,É,É,Á,Ä,μ,Ü,±,Æ,ª, ,è,Ü,·BfRf"fgf[f<fpfj<,É,Ç,ìŠÇ—  
fC[f<,ðŽg,ì,é,Æ,«,ì,ç,Á,Ä,àAfCfWfXfgfŠ fGffBf^,Á,í,É,,»,é,ç,ìŠÇ—fC[f<,ðŽg,Á,Ä\  
—,ì•ìX,ðs,Á,Ä,¾,¾,çBfCfWfXfgfŠ fGffBf^,ð—p,ç,Á'ì,ð•ìX,μ,Ä,ç,é,Æ,«,É"ü—  
ì,ðŠÔ^á,ì,Ä,àAfCfWfXfgfŠ fGffBf^,ì^Ó—ìä,ìfGf%o[f,ðŽ•É,Á,«,É,ç,ì,ÄACEx,ì,ì\Ž!,¾,è,Ü,¹,ñB

## fCfWfXfgfŠ fGffBf^,ðŽg—p,μ,Ä FTP fT[fO[f T[fRfX~-,ð•ìX,·,é,É,í

1. fTf@fCf< f}f[fWff,Ü,½,ìfvf[fOf%o[f f}f[fWff,ì REGEDT32.EXE ,ð<N" @,·,é,©AfRf}f"fh  
fvf"fvfg,É **start regedt32** ,Æ"ü—í,μAEnter fL[f,ð%ÿ,μ,Ü,·B  
  
fCfWfXfgfŠ fGffBf^,ìfEfB"fhfE,ª\Ž!,¾,è,½,çAF1 fL[f,ð%ÿ,¹,ìfCfWfXfgfŠ fGffBf^,Á,ììX•ù-  
@,ðŽ!,·fvf<fv,ª\Ž!,¾,è,Ü,·B

2. fCfWfXfgfŠ fGffBf^,ÁA[f[f< f}fvf"ä,ì HKEY\_LOCAL\_MACHINE] ,Æ,ç  
,±f^fCfGf<,ìfEfB"fhfE,ðNfŠfbfN,μAZÿ,ìTfufL[f,É'B,·,é,Ü,Á SYSTEM  
fTfufcfS[f,ìfAfCfRf" ,ðf\_fuf<fNfŠfbfN,μ,Ä,ç,«,Ü,·B  
..SYSTEMCurrentControlSetServicesftpsvcParameters  
  
,±,±,Áà-¾,·,éPf%o[f^,íA,·,x,Ä,±,ìfCfWfXfgfŠ fTfufL[f,ì%º,É"z'u,¾,è,Ä,ç,Ü,·B

Žÿ,ÉAFTP fT[fO[f T[fRfX fPf%o[f^,ì,±,ìAfCfWfXfgfŠ fGffBf^,Á,ì,ÿfGf"fgfŠ,ð'Ç  
%Á,μ,½,è'ì,ð•ìX,Á,«,éPf%o[f^,ì'fGf"fgfŠ,É,Á,ç,Äà-¾,μ,Ü,·B,±  
,é,ç,ì'fGf"fgfŠ,íAfffHf<fg,Á,ìfCfWfXfgfŠ,É•\  
Ž!,¾,è,Ü,¹,ñ,ì,ÄAfffHf<fg'ì,ð•ìX,μ,½,çè#ìAfGf"fgfŠ,ð'Ç%Á,·,é•K—v,ª, ,è,Ü,·B

## AnnotateDirectories

```
f[f^e^ = REG_DWORD  
"íí = 0 ,Ü,½,í 1  
fffHf<fg = 0 (<U[]ffBfCfNfgfŠ fRf"fg,ìfjft)  
,±,ì'fGf"fgfŠ,íAV<KÜ'±ft[fU[f,É'í,·,éffBfCfNfgfŠ  
fRf"fg,ìfffHf<fg,ì" @ì,ð'è<,μ,Ü,·BffBfCfNfgfŠà-¾,íAFTP[f[]ä,ìffBfCfNfgfŠ,ì"à—e,ðAFTP  
ft[fU[f,É'm,ç,¹,é,à,ì,Ä,·BffBfCfNfgfŠà-¾,íA~FTPSVC~.CKM ,Æ,ç,±-  
¼'0,ìftf@fCf<,É•Ü'¶,¾,è,Ü,·B,±,ìftf@fCf<,íA'Éí,ì%B,μftf@fCf<,Á,·B,±,ì'ì,ð 1  
,Éÿ'è,·,é,ÆAfffBfCfNfgfŠ fRf"fg,ìfjft",É,É,è,Ü,·B
```

## ExitMessage

```
f[f^e^ = REG_SZ  
"íí = •¶Žš—ñ  
fffHf<fg = "Goodbye."  
,±,ì'fGf"fgfŠ,íAquit fRf}f"fh,ðŽóM,μ,¾,ç FTP fNf%o[fCfAf"fg,É'—M,¾,è,éftfCf"flft  
f[fBfZ[fW,ð'è<,μ,Ü,·B
```

## GreetingMessage

```

ff[f^e^ = REG_MULTI_SZ
"íí = •qžš—ñ
fftfHf<fg = ,È,μ ("Á•Ê,È<N"®f[]bfZ[]fW,í,È,ç)
,±,ì'lfgf"fgfš,í[]A[]V<KfNf%ofCfAf"fg,ìfAfJfEf"fg,³—LCEø%»»,³,è,½CEä,±,è,ç,ìfNf%ofCfAf"fg,É'—
[]M,³,è,é[]fbfZ[]fW,ð'è<',μ,Ü,·[]BInternet []ä,Ä,ì<K-ñ,É[],ç[]AfNf%ofCfAf"fg,³"½-
¼,Äf[]Ofif",μ,Äf}fCfifX (-) ,Äžn,Ü,é ID ,ðžw'è,μ,½[]è[]#[]A,±,ì<N"®f[]bfZ[]fW,í'—[]M,³,è,Ü,¹,ñ[]B

```

### LogAnonymous

```

ff[f^e^ = REG_DWORD
"íí = 0 ,Ü,½,í 1
fftfHf<fg = 0 (<U[][]-CE±,μ,½"½-¼f[]Ofif",ìf[]fO,ížú[]W,μ,È,ç)
,±,ì'lfgf"fgfš,í[]A"½-¼f[]Ofif",ìfvfXfef€ fCxf"fg f[]fO,Ö,ìf[]fOžú[]W,ð—LCEø,Ü,½,í-³CEø,É,μ,Ü,·[]B

```

### LogNonAnonymous

```

ff[f^e^ = REG_DWORD
"íí = 0 ,Ü,½,í 1
fftfHf<fg = 0 (<U[][]-CE±,μ,½"½-¼,Ä,È,çf[]Ofif",ìf[]fO,ížú[]W,μ,È,ç)
,±,ì'lfgf"fgfš,í[]AfVfXfef€ fCxf"fg f[]fO,Ö,ì"½-¼,Ä,È,çf[]Ofif",ìf[]fOžú[]W,ð—LCEø,Ü,½,í-
³CEø,É,μ,Ü,·[]B

```

### MaxClientsMessage

```

ff[f^e^ = REG_SZ
"íí = •qžš—ñ
fftfHf<fg = "Maximum clients reached, service unavailable."
,±,ì'lfgf"fgfš,í[]A[]Á'áfNf%ofCfAf"fg",É'B,μ,½,è,»,è,ð',,½[]è[]#,É FTP fNf%ofCfAf"fg,É'—
[]M,³,è,é[]fbfZ[]fW,ðžw'è,μ,Ü,·[]B,±,ìf[]fbfZ[]fW,í[]ACE»Ý[]AfT[]fo[][,í[]Á'â[]ú'±",ðft[]f[]fX,μ,Ä,ç
,é,ì,Ä'Ç%oAfNf%ofCfAf"fg,ð<'Ú,μ,Ä,ç,é,±,Æ,ðž,μ,Ü,· ( []Á'â[]ú'±",í[]A[FTP fT[]f[]fX] f_fCfAf[]fO
f{fbfNfX,Ü,½,ìf[]f[]fXf[]f[]fš,ì MaxConnections fgf"fgfš,Äžw'è,μ,Ü,·)[]B

```

### MsdosDirOutput

```

ff[f^e^ = REG_DWORD
"íí = 0 ,Ü,½,í 1
fftfHf<fg = 1 ( [][]fffbf[]f[]f[]fš^è—,í MS-DOS ,ìCE`ž®,ì,æ,x,É•ž!,³,è,é)
,±,ì'lfgf"fgfš,í[]Afffbf[]f[]f[]fš"®[],Æ,μ,Ä list frf}f"fh,ì[]o—íCE`ž®,ð[]AMS-DOS ,ì dir frf}f"fh,Ü,½,í UNIX
,ì ls frf}f"fh,ì,ç,ç,ì[]o—íCE`ž®,Éž—,¹,é,©,ðžw'è,μ,Ü,·[]B,±,ì'l,í[]Apwd frf}f"fh,Ä'—,ç,è,épfX"à,ìfXf
%ofbfVf...,Æ%~<L[]t,Æ,ì[]Ø,è'Ö,ì,à[]$CEä,μ,Ü,·[]B
,±,ì'l,ð 1 ,É[]Ý'è,·,é,Æ[]Afffbf[]f[]f[]fš^è—CE`ž®,í MS-DOS ,ì^è—CE`ž®,Éž—
,½,à,ì,É,è[]Afffbf[]f[]f[]fš<L[]t,í%~<L[]t (\) ,É,È,è,Ü,·[]B0 ,É[]Ý'è,·,é,Æ[]Afffbf[]f[]f[]fš^è—CE`ž®,í
UNIX ,ì^è—CE`ž®,Éž—,Ä[]Afffbf[]f[]f[]fš<L[]t,ìfXf%ofbfVf...<L[]t (/) ,É,È,è,Ü,·[]B

```

žÿ,ì 2 ,Ä,ìfpf%of[]f^,í[]AFTP fT[]fo[][,ìš^"®[]ó<μ,ìf[]fO,ð[]\$CEä,μ,Ü,·[]B

### LogFileAccess

```

ff[f^e^ = REG_DWORD
"íí = 0[]`2
fftfHf<fg = 0
FTP fT[]fo[][ ftf[]f[]f< fAfNfZfX,ìf[]fO,ì"®[],ð[]Ý'è,μ,Ü,·[]B,±,ìfGf"fgfš,É,í[]AZÿ,ì 3 ,Ä,ì'l,ì,x,ç[]A1

```

,Á,ðŸ'è,μ,Û,·□B

0 = ftf@fCf< fAfNfZfX,ìf□fO,ð□s,í,È,† (ffftfHf<fg)□B

1 = ftf@fCf< fAfNfZfX,ìf□fO,ð FTPSVC.LOG ,É<L~^,·,é□B

2 = ftf@fCf< fAfNfZfX,ìf□fO,ð FTyymmdd.LOG ,É<L~^,·,é□Byy ,É,ÍCE»□Ÿ,ì□¼—ï”N□Amm  
,É,ÍCE»□Ÿ,ìCEŽ□A,»,μ,Ä dd ,É,ÍCE»□Ÿ,ì“ú•t,¯,ª“ü,è,Û,·□B□V,μ,†f□fO ftf@fCf<,í□A•K—v,É  
%ož,¶,ÄŠj,©,ê,Û,·□B

**LogFileDirectory**

ff□[f^CE^ = REG\_SZ

ffftfHf<fg = %SystemRoot%\SYSTEM32

f□fO ftf@fCf<,ìfffBfCEfNfgfŠ,ðŽw'è,μ,Û,·□Bf□fO ftf@fCf<,ÍfvfXfef€ fp□[fefBfvf†“,©,ç□Ø,è—£,·,±  
,Æ,ª,Ä,«,Û,·□B

ŽŸ,ìfCEfWfXfgfŠ fpf%of□□[f^,í□Aflfbfgf□□[fN,ì□Ÿ'è] f\_fCfAf□fO f{fbfNfX,Ä FTP f□fO□[ f□f[frfX,ð□\  
□→,·,é,Æ,«,É—~—p,Ä,«,éflfvfVf†“,ðŽg,Ä,ÄŸ'è,Ä,«,Û,·□B

**AllowAnonymous**

**AnonymousOnly**

**AnonymousUsername**

**ConnectionTimeout**

**HomeDirectory**

**MaxConnections**

ŽŸ,ìfCEfWfXfgfŠ fpf%of□□[f^,í□Afrf“fgf□□[f< fpflf<,Ä [FTP f□fO□[□[ ,ð<N“@,μ□A[fZfLf...fŠfefB]  
f{f^f“,ðfNfŠfbfN,μ,¼,Æ,«—~—p,Ä,«,éflfvfVf†“,ðŽg,Ä,ÄŸ'è,Ä,«,Û,·□B

**ReadAccessMask**

**WriteAccessMask**

fCEfWfXfgfŠ fGfffBf^,Ä,±,è,ç,ìfpf%of□□[f^,É“ü—í,Ä,«,é'l,ì”í'í,í□A,±,ì□í,ìŠÖ~A,·,éf\_fCfAf□fO f{fbfNfX,Ä□à-  
¾,μ,¼,à,ì,Æ“¯,¶,Ä,·□B,±,è,ç,ì'l,ì□Ÿ'è,É,í□A[FTP f□fO□[□[ f□f[frfX] f\_fCfAf□fO f{fbfNfX,¾,¯,ðŽg—p,μ,Ä,-  
,¾,¾,ç□B

## TCP/IP fT[fX,Ä,lpftfH[f]}f“fX f,fjf^,lžg—p

,±,±,Ä,íAfpftfH[f]}f“fX f,fjf^,ÉOf%oft%»Ä,«,éfpftfH[f]}fX fjfEf“f^,É,Ä,ç,Äà-¾,µ,Ü,·B,±,é,ç,lfjEf“f^,É,æ,èAIP fvffgfRf<AFTP fT[fo[ fT[fX fgf%ftfBfbfN[A,“,æ,Ń WINS fT[fo[,lpftfH[f]}f“fX,đ’çÖ,·,é,±,Æ,ª,Ä,«,Ü,·B

d—v : fpftfH[f]}f“fX f,fjf^,Ä TCP/IP fpftfH[f]}fX fjfEf“f^,đŽg,æ,É,íASNMP fT[fX,đ’g,Ýž,þ•K—v,ª, ,è,Ü,·B

 [TCP/IP,ÄfpftfH\[f\]}f“fX f,fjf^,đŽg,æ](#)

 [TCP/IP fpftfH\[f\]}f“fX,đŠÄŽ<,·,é](#)

 [FTP fT\[fo\[ fgf%ftfBfbfN fpftfH\[f\]}f“fX,đŠÄŽ<,·,é](#)

 [WINS fT\[fo\[ fpftfH\[f\]}f“fX,đŠÄŽ<,·,é](#)

**TCP/IP ,ÁfpftfH[f]f“fX f,fjf^ ,ðŽg,»**

**TCP/IP ,ÁfpftfH[f]f“fX f,fjf^ ,ðŽg,»É,Í**

1. fv[Of%œf€ f}f[OfWff,ì [ŠÇ—[fc[f<] fOf<[fv,ÁAfpftfH[f]f“fX f,fjf^ ,ðf\_fuf<fNfŠfbfN,μ,Û,·B
2. [•Ò[W] fffj...[,ì [fOf%œft,É'Ç%Á] fRf}f“fh,ð'l,Ñ,Û,·B
3. [fOf%œft,É'Ç%Á] f\_fCfAf[Of f{fbfNfX,Á [fRf“fsf...[f^] ^è—,©,çŠĂŽ<.,éfRf“fsf... [f^,ð'l'ð,μ,Û,·B
4. [fufWfFfNfg] ^è—,©,çŠĂŽ<.,é TCP/IP ŠÖ~Afvf[fZfX,ð'l'ð,μ,Û,·BFTP Server[AICMP[AIP[ANetwork Interface[ATCP[AUDP[A,Û,½,Í WINS Server ,ì,ç,.,é,©,ð'l'ð,μ,Û,·B
5. [fjEf“f^] ^è—,©,çŠefvf[fZfX,É'Í,μ,ĂŠĂŽ<.,éfjEf“f^ ,ð'l'ð,μ[A['Ç%Á] f{f^f“ ,ðfNfŠfbfN,μ,Û,·BŠefjEf“f^ ,ìÚx,É,Á,ç,Ă,Í[A[à-¾] f{f^f“ ,ðfNfŠfbfN,μ,Ăà-¾,ð•\ Ž!,μ,Û,·B
6. fOf%œft,É,μ,½,çfjEf“f^ ,ð,·,×,Ă'l'ð,μ,ì,½,ç[A[Š®—¹] f{f^f“ ,ðfNfŠfbfN,μ,Û,·B

fpftfH[f]f“fX f,fjf^ ,ìŽg,ç•ú,É,Á,ç,ĂÚ,μ,,Í[AwWindows NT fvXfef€ fKfCfh[x,ìufpftfH[f]f“fX f,fjf^v,ìÍ,ðŽQ[Æ,μ,Ă,,¾,³,çB







R, ĹŽóMfppPfbfg, Ĺ" B

**Packets Received/Second**

f}fbfgfN fCf" f^ [ftfFfCfXă, ĹŽóM, ., éfpfPfbfg, Ĺ"ă—|

**Packets Sent Non-Unicast/Second**

□, ^Ê'w, Ĺvf□fgfRf<, a—v<□, ., é□A" ņftfjLfffXfg (, Ĺ, Ü, è□Aftfuflfbfg fuf□□[fhfLfffXfg, Ü, ½, Ĺftfuflfbfg f}f<f`fLfffXfg) fAfhfĈfX, Ö, ĹpfPfbfg'—□M"ă—|□B"pŠü, ³, ê, ½, ©'— □M, ³, ê, È, ©, Ĺ, ½fpfPfbfg, àŠÜ, Ü, ê, Ü, .□B

**Packets Sent Unicast/Second**

□, ^Ê'w, Ĺvf□fgfRf<, a—v<□, ., é□Aftfuflfbfg ftfjLfffXfg fAfhfĈfX, Ö, ĹpfPfbfg'—□M"ă—|□B"pŠü, ³, ê, ½, ©'— □M, ³, ê, È, ©, Ĺ, ½fpfPfbfg, Ĺ'—□M"ă—|, àŠÜ, Ü, ê, Ü, .□B

**Packets Sent/Second**

f}fbfgfN fCf" f^ [ftfFfCfXă, Ĺ'—□M, μ, ½fpfPfbfg, Ĺ"ă—|

**Packets/Second**

f}fbfgfN fCf" f^ [ftfFfCfXă, Ĺ'—ŽóM, μ, ½fpfPfbfg, Ĺ"ă—|







**Received Source Quench**

ŽóM,μ,½ ICMP Source Quench ffbfZ[fW,ì”

**Received Time Exceeded**

ŽóM,μ,½ ICMP ŽžŠÔ’ %ßfbfZ[fW,ì”

**Received Timestamp Reply/Second**

ŽóM,μ,½ ICMP f^fCf€fXf^f“fv%ž”šfbfZ[fW,ì”ä—!

**Received Timestamp/Second**

ŽóM,μ,½ ICMP f^fCf€fXf^f“fv (—v<□) ffbfZ[fW,ì”ä—!

**Sent Address Mask**

‘—M,μ,½ ICMP fAfhf€fX f}fXfN—v<□fbfZ[fW,ì”

**Sent Address Mask Reply**

‘—M,μ,½ ICMP fAfhf€fX f}fXfN%ž”šfbfZ[fW,ì”

**Sent Destination Unreachable**

‘—M,μ,½ ICMP ‘—M□æ“ž’B•s”\fbfZ[fW,ì”

**Sent Echo Reply/Second**

‘—M,μ,½ ICMP fGfR□[%ž”šfbfZ[fW,ì”ä—!

**Sent Echo/Second**

‘—M,μ,½ ICMP fGfR□[ ffbfZ[fW,ì”ä—!

**Sent Parameter Problem**

‘—M,μ,½ ICMP fpf%□□f^□áŠQfbfZ[fW,ì”

**Sent Redirect/Second**

‘—M,μ,½ ICMP fŠ\_fCf€fNfg ffbfZ[fW,ì”ä—!

**Sent Source Quench**

‘—M,μ,½ ICMP Source Quench ffbfZ[fW,ì”

**Sent Time Exceeded**

‘—M,μ,½ ICMP ŽžŠÔ’ %ßfbfZ[fW,ì”

**Sent Timestamp Reply/Second**

‘—M,μ,½ ICMP f^fCf€fXf^f“fv%ž”šfbfZ[fW,ì”ä—!

**Sent Timestamp/Second**

‘—M,μ,½ ICMP f^fCf€fXf^f“fv (—v<□) ffbfZ[fW,ì”ä—!

## TCP f p f t f H [ f ] f " f X f j f E f " f ^

TCP f l f u f W f f N f g f ^ f C f v , É , Í □ A T C P ( T r a n s m i s s i o n C o n t r o l P r o t o c o l ; " ` ' — □ § C E ä f v f □ f g f R f < ) , ð Ž g — p , μ , Ä , † , é " Á ' è , ì f G f " f e f B f e f B , a □ A T C P f z f O f □ f " f g , ð ' — Ž ó □ M , , é " ä — ì , ð Ž ì , . f j f E f " f ^ , a Š Ů , Ů , è , Ů , . □ B , Ů , ½ □ A % o Ä " \ , È Š e T C P □ Ů ' ± □ ó ' Ö , Å , Ì T C P □ Ů ' ± , ì □ " , à Ž ì , μ , Ů , . □ B

### Connection Failures

TCP □ Ů ' ± , a □ A S Y N - S E N T □ ó ' Ö , Ů , ½ , Í S Y N - R C V D □ ó ' Ö , © , † C L O S E D □ ó ' Ö , É ' ¼ □ Ů ' J ^ Ů , μ , ½ % o ñ □ " , Æ □ A S Y N - R C V D □ ó ' Ö , © , † L I S T E N □ ó ' Ö , É ' ¼ □ Ů ' J ^ Ů , μ , ½ % o ñ □ " , Ì □ † C E v

### Connections Active

TCP □ Ů ' ± , a □ A C L O S E D □ ó ' Ö , © , † S Y N - S E N T □ ó ' Ö , É ' ¼ □ Ů ' J ^ Ů , μ , ½ % o ñ □ "

### Connections Established

Æ » □ Ý , ì □ ó ' Ö , a E S T A B L I S H E D , Ů , ½ , Í C L O S E - W A I T , Å , , é T C P □ Ů ' ± , ì □ "

### Connections Passive

TCP □ Ů ' ± , a □ A L I S T E N □ ó ' Ö , © , † S Y N - R C V D □ ó ' Ö , É ' ¼ □ Ů ' J ^ Ů , μ , ½ % o ñ □ "

### Connections Reset

TCP □ Ů ' ± , a □ A E S T A B L I S H E D □ ó ' Ö , Ů , ½ , Í C L O S E - W A I T □ ó ' Ö , © , † C L O S E D □ ó ' Ö , É ' ¼ □ Ů ' J ^ Ů , μ , ½ % o ñ □ "

### Segments Received/Second

Ž ó □ M , μ , ½ f z f O f □ f " f g , ì " ä — ì □ B Ž ó □ M , É f G f % o □ [ , a , , Á , ½ f z f O f □ f " f g , à Š Ů , Ů , è , Ů , . □ B , ± , ì f j f E f " f ^ , Í □ A C E » □ Ý Š m — š , μ , Ä , † , é □ Ů ' ± □ ä , Å Ž ó □ M , μ , ½ f z f O f □ f " f g , ð Š Ů , Ý , Ů , . □ B

### Segments Retransmitted/Second

□ Ä ' — □ M , ³ , è , ½ f z f O f □ f " f g , ì " ä — ì □ B , Ä , Ů , è □ A ^ È ' O , É ' — □ M , ³ , è , ½ f o f C f g , ð 1 , Ä , Ů , ½ , Í • ; □ " Š Ů , ñ , Å , † , é f z f O f □ f " f g , ì ' — □ M " ä — ì , Å , . □ B

### Segments Sent/Second

' — □ M , ³ , è , ½ f z f O f □ f " f g , ì " ä — ì □ B , ± , ì f j f E f " f ^ , Í □ A C E » □ Ý , ì □ Ů ' ± □ ä , ì f z f O f □ f " f g , ð Š Ů , Ý , Ů , . , a □ A □ Ä ' — □ M f o f C f g , μ , © Š Ů , ñ , Å , † , È , † f z f O f □ f " f g , Í Š Ů , Ý , Ů , ¹ , ñ □ B

### Segments/Second

TCP f v f □ f g f R f < , ð Ž g , Á , Ä ' — Ž ó □ M , ³ , è , ½ T C P f z f O f □ f " f g , ì " ä — ì



## UDP f jfufWfFfNfg f^fCfv,É,Í AUDP (User Datagram Protocol; f t [ f U [ f f [ f ^ f O f % o f € f v f [ f g f R f < ) , ð Ž g —

p, μ, Å, ç, é “Á” è, ì f G f “ f e f B f e f B, a [ AUDP f f [ f ^ f O f % o f € , ð ‘ — Ž ó [ M, , é ” ä —  
! , ð Ž ! , · f j f E f “ f ^ , a Š Ü, Ü, ê, Û, · [ B, Ü, ½ [ AUDP f v f [ f g f R f < , ì Š e Ž í, ì f G f % o [ f j f E f “ f g, ð Ž ! , · f j f E f “ f ^ , à Š Ü, Ü, ê, Û, · [ B

## Datagrams No Port/Second

‘ — [ M [ a e f [ [ f g, É f A f v f Š f P [ [ v f f “ , a, È, ç UDP f f [ f ^ f O f % o f € , ð Ž ó [ M, μ, ½ ” ä — !

## Datagrams Received Errors

‘ — [ M [ a e f [ [ f g, É f A f v f Š f P [ [ v f f “ , a, È, ç, Æ, ç, x ^ È Š O, ì — [ — R, Å ” z [ M • s ” \, ì UDP f f [ f ^ f O f % o f € , ð Ž ó [ M, μ, ½ [ ”

## Datagrams Received/Second

UDP f t [ f U [ , Ö UDP f f [ f ^ f O f % o f € , a ” z [ M, ³, ê, ½ ” ä — !

## Datagrams Sent/Second

f G f “ f e f B f e f B, © , ç ‘ — [ M, ³, ê, ½ UDP f f [ f ^ f O f % o f € , ì ” ä — !

## Datagrams/Second

f G f “ f e f B f e f B, Å ‘ — Ž ó [ M, ³, ê, ½ UDP f f [ f ^ f O f % o f € , ì ” ä — !



FTP fT[fO[,"É"~Žž,ÉÚ'±%oÂ"\,È"ñ"½-¼ft[fU[,ìÅ'â"

**Total Anonymous Users**

FTP fT[fO[,ÉÚ'±,μ,½"½-¼ft[fU[,ì—Ýv

**Total NonAnonymous Users**

FTP fT[fO[,ÉÚ'±,μ,½"ñ"½-¼ft[fU[,ì—Ýv

### WINS fT[f]o[f] fpftfH[f]f“fX,đŠĂŽ<.,,é

WINS fT[f]o[f] [đ'g,Ýž,þ,Æ,«,ÉjJfE“f^,àž©“@“l,É'g,Ýž,Ü,è,é,½,β AfpftfH[f]f“fX  
f.fjf^,đžg,Ă,Ă AWINS fT[f]o[f] fT[f]rfX,lfpftfH[f]f“fX,đ•Ž!,.,é,±,Æ,ª,Ă,«,Ü,· B

### WINS fT[f]o[f] fT[f]rfX,ÉCEĀ—L,ìjJfE“f^,đ•Ž!,.,é,É,Í



[fpftfH[f]f“fX f.fjf^] fEfBf“fhfE,ì [flfufWfFfNfg] ^ê—,©,ç [WINS Server] ,đ'l'đ,μ,Ü,· B^È  
%o,Ā à-¾,.,é ASĂŽ<,μ,½,č “ CEvî•ň,ìjJfE“f^,đ'l'đ,μ,Ü,· B

### Failed Queries/Second

1 • b“-,½,è,ìž,“s,μ,½ AE%oi,ì' B

### Failed Releases/Second

1 • b“-,½,è,ìž,“s,μ,½ %ođ•ú,ì' B

### Group Conflicts/Second

WINS fT[f]o[f] [,žó,žæ,Á,½ fOf<[fv“o~^,ì,α,ž Af[f]f^fx[fX“à,]fCEFR[fh,Æ<£þ,μ,½,à,ì,]”ä—!

### Group Registrations/Second

WINS fT[f]o[f] [,žó M,μ,½ fOf<[fv“o~^,]”ä—!

### Group Renewals/Second

WINS fT[f]o[f] [,žó M,μ,½ fOf<[fv X V,]”ä—!

### Queries/Second

1 • b“-,½,è,ì AE%oi,ì' B B,±,é,Í AWINS fT[f]o[f] [,žó M,μ,½ AE%oi,ì”ä—!,Ā,· B

### Releases/Second

1 • b“-,½,è,ì %ođ•ú,ì' B B,±,é,Í AWINS fT[f]o[f] [,žó M,μ,½ %ođ•ú,]”ä—!,Ā,· B

### Successful Queries/Second

1 • b“-,½,è,ì CE÷,μ,½ AE%oi,ì' B

### Successful Releases/Second

1 • b“-,½,è,ì CE÷,μ,½ %ođ•ú,ì' B

### Total Number of Conflicts/Second

[Unique Conflicts/Second] ,Æ [Group Conflicts/Second] ,ìþ CEv B,±,é,Í AWINS fT[f]o[f] [,Ā”-  
þ,μ,½ <£þ,ì' ”ä—!,Ā,· B

### Total Number of Registrations/Second

[Unique Registrations/Second] ,Æ [Group Registrations/Second] ,ìþ CEv B,±,é,Í AWINS  
fT[f]o[f] [,žó M,μ,½ “o~^,]”ä—!,Ā,· B

### Total Number of Renewals/Second

[Unique Renewals/Second] ,Æ [Group Renewals/Second] X V,ìþ CEv B,±,é,Í AWINS  
fT[f]o[f] [,žó M,μ,½ X V,]”ä—!,Ā,· B

### Unique Conflicts/Second

WINS fT[f]o[["ŽóM,μ,½^ê^Ó,"o~^,Æ["<Š·,ì,ì,ϣ,¿Aff[f^fx[fX"à,}fCFR[fh,Æ<£[‡,μ,½,à,ì,"ä—  
!B

**Unique Registrations/Second**

WINS fT[f]o[["ŽóM,μ,½^ê^Ó,"o~^,"ä—!

**Unique Renewals/Second**

WINS fT[f]o[["ŽóM,μ,½^ê^Ó[X[V,"ä—!

## TCP/IP ^óü,É,Ä,ç,Ä

□,È,,Æ,à 1 'ä,ì Windows NT fRf"fsf...□[f^,É TCP/IP ^óü (TCP/IP printing) ,a'g,Ý□ž,Ü,ê,Ä,ç  
,ê,ì□Aft□[fU□[,í□AMicrosoft flfbfgf□□[fN□ä,ì,ç,ìfRf"fsf...□[f^,©,ç,Ä,à'¼□Ú□Ú'±,³,ê,½ TCP/IP  
fvfŠf"f^,â□AUNIX fRf"fsf...□[f^,É" —□"l,É□Ú'±,³,ê,½fvfŠf"f^,É^óü,.,é,±,Æ,ª,Ä,«,Ü,·□B,Ü,½□AUNIX  
fRf"fsf...□[f^,©,ç Windows NT fRf"fsf...□[f^,É^óü,.,é,±,Æ,à,Ä,«,Ü,·□B

Microsoft TCP/IP ^óü,í□ARFC (Request for Comments) 1179 ,É□€<',μ,Ä,ç,Ü,·□B

^È%º,ì□€-Ú,Ä,í□AWindows NT fRf"fsf...□[f^,É TCP/IP ,a'g,Ý□ž,Ü,ê,Ä,ç,é□é□#,É TCP/IP  
fvfŠf"f^,ð□ì□-,.,é•û-@,É,Ä,ç,Ä□à-¾,μ,Ü,·□B



[TCP/IP ^óü,ìŠT—v](#)



[TCP/IP ^óü,ì,½,ß Windows NT,ðfZfbfgfAfbfv,.,é](#)



[TCP/IP ^óü,ì,½,ß,ÉfvfŠf"f^,ð□ì□-,.,é](#)



[UNIX fNf%ºfCfAf"fg,©,ç Windows NT ,É^óü,.,é](#)

fvfŠf"f^,Ä,ì□ì<Æ,ì□Ú□×,É,Ä,ç,Ä,í□A□wWindows NT fvfxfef€ fkfCfh□x,ì□u'æ 6 □í□@fvfŠf"fg  
f}fì□[fWff□v,ðžQ□Æ,μ,Ä,¾,³,ç□B

## TCP/IP 600, IST-v

• ; " , i ž í - p , i f R f " f s f . . . [ f ^ , a f i f y f C E [ f e f B f " f o f v f X f e f e , © , ç [ \ [ - , ³ , è , Ä , ç , é Windows NT f C f " f ^ [ f l f b f g f [ f N , Ä , í A M i c r o s o f t T C P / I P , ð - ~ - p , µ , Ä A U N I X f R f " f s f . . . [ f ^ C E o - R , Ä [ Ú ' ± , ³ , è , Ä , ç , é f v f Š f " f ^ , â A ( ' g , Ý ž , Ý f l f b f g f [ f N f A f \_ f v f ^ f [ f h , Ü , ½ , í f v f Š f A f < / f p f % o f C E f < f C [ f T f l f b f g f v f Š f " f g f T [ f o [ [ C E o - R , Ä ) f l f b f g f [ f N , É ' ¼ [ Ú [ Ú ' ± , ³ , è , ½ f v f Š f " f ^ , É Š È ' P , É [ o - í , , é , ± , Æ , a , Ä , « , Ü , . [ B

, ± , i ž í , i f C f " f ^ [ f l f b f g f [ f N , Ä , í A W i n d o w s N T W o r k s t a t i o n , , æ , Ñ W i n d o w s N T S e r v e r f R f " f s f . . . [ f ^ , É % o Ä , , i , Ä A M S - D O S , Ä L A N M a n a g e r f l f b f g f [ f N f v f t f g f E f f A , ð Ž Ä [ s , , é f R f " f s f . . . [ f ^ , a Š Ü , Ü , è , é [ é [ ± , à , , è , Ü , . [ B

M i c r o s o f t T C P / I P ^ 6 0 0 , ð - ~ - p , , é , É , í [ A T C P / I P f v f Š f " f ^ , ð ' è < , , é 1 ' à , i W i n d o w s N T f R f " f s f . . . [ f ^ , É [ A T C P / I P , ð ' g , Ý ž , ß , í , æ , ç , ¾ , - , Ä , . [ B f C f " f ^ [ f l f b f g f [ f N [ ä , i f R f " f s f . . . [ f ^ , í , , x , Ä A W i n d o w s N T T C P / I P f v f Š f " f g f T [ f o [ [ , Æ < x - L , µ , Ä , ç , é % ½ , ç , © , í f v f [ f g f R f < , ð Ž g , Ä , Ä [ A , ± , è , ç , í f v f Š f " f ^ , É ^ 6 0 0 , , é , ± , Æ , a , Ä , « , Ü , . [ B , Ü , © , í f N f % o f C f A f " f g f R f " f s f . . . [ f ^ , É , í T C P / I P , ð ' g , Ý ž , p • K - v , í , , è , Ü , ¹ , ñ [ B , Ä , Ü , è [ A W i n d o w s N T f v f Š f " f g f T [ f o [ [ , Æ , µ , Ä < @ \ , , é f R f " f s f . . . [ f ^ , í [ A T C P / I P f v f Š f " f ^ , É ^ 6 0 0 , , é % o Ä " \ [ « , a , , é f N f % o f C f A f " f g , Ä Ž g , í , è , Ä , ç , é , , x , Ä , í f v f [ f g f R f < , ð - p , ç , Ä [ \ [ - , µ , Ä , , , • K - v , a , , è , Ü , . [ B

T C P / I P ^ 6 0 0 , ð ' g , Ý ž , ñ , Ä , ç , é W i n d o w s N T f R f " f s f . . . [ f ^ , í A U N I X f v f Š f " f ^ , Ü , ½ , í ' ¼ [ Ú [ Ú ' ± , ³ , è , ½ f v f Š f " f ^ , É ' ¼ [ Ú ^ 6 0 0 , , é , ± , Æ , a , Ä , « [ A " Ž Ž , É , Ü , © , í f l f b f g f [ f N f T [ f U [ [ , í f Q [ [ f g f E f f C , Æ , µ , Ä < @ \ , , é , ± , Æ , a , Ä , « , Ü , . [ B

Ž Ÿ , i M i c r o s o f t f l f b f g f [ f N , í [ \ [ - - á , Ä , í [ A , , x , Ä , i f R f " f s f . . . [ f ^ , í f l f b f g f [ f N [ ä , i \ \ N T \ P 1 , Æ \ \ N T \ P 2 , Æ , ç , x - ¼ ' O , í f v f Š f " f ^ , É [ Ú ' ± , , é , ± , Æ , a , Ä , « , Ü , . [ B 1 , Ä , í A ' ¼ [ Ú [ Ú ' ± , ³ , è , ½ f v f Š f " f ^ , Ä , , è [ A , à , x 1 , Ä , í U N I X f R f " f s f . . . [ f ^ , É [ Ú ' ± , ³ , è , ½ f v f Š f " f ^ , Ä , . [ B , ± , è , ç 2 , Ä , i T C P / I P f v f Š f " f ^ , í A M i c r o s o f t T C P / I P , æ ' g , Ý ž , Ü , è , ½ W i n d o w s N T f R f " f s f . . . [ f ^ , É , æ , è [ \ [ - , ³ , è , Ü , µ , ½ [ B , ± , í - á , Ä , í [ A T C P / I P , ð Ž g - p , , é W i n d o w s N T f R f " f s f . . . [ f ^ , í - ¼ ' O , í n t , Ä , . [ B f v f Š f " f ^ , í - ¼ ' O , í [ A , » , è , ¼ , è p 1 , , æ , Ñ p 2 , Ä , . [ B

M i c r o s o f t T C P / I P , ð Ž g , Ä , ½ T C P / I P f v f Š f " f ^ , Ü , ½ , í U N I X f v f Š f " f ^ , Ö , í ^ 6 0 0

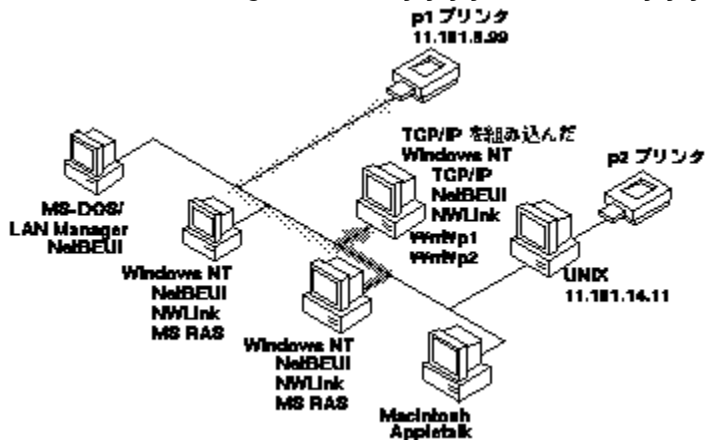

f R f } f " f h f v f [ " f v f g , Ä l p r [ Ú ' ± f T [ f e f B f Š f e f B , ð Ž g , x , ± , Æ , É , æ , è [ A L P D f T [ f o [ [ , ð Ž Ä [ s , µ , Ä , ç , é f z f X f g , É f t f [ C f < , ð ^ 6 0 0 , , é , ± , Æ , a , Ä , « , Ü , . [ B , Ü , ½ [ A l p g [ f " f f T [ f e f B f Š f e f B , É , æ , è [ A L P D f T [ f o [ [ , ð Ž Ä [ s , µ , Ä , ç , é f z f X f g [ ä , í ^ 6 0 0 , Ò , ç [ s - ñ , í [ ó ' Ö , ð Š m " F , , é , ± , Æ , à , Ä , « , Ü , . [ B

**TCP/IP ^óü, ð, ½, B Windows NT , ðfZfbfgfAfbfv, , é**

Microsoft TCP/IP , Æ TCP/IP ^óüúTf| [fg, á'g, Ýž, Ü, è, ½ Windows NT fRf"fsf... [f^, Å, , è, ÍA, ç, , è, Ì  
Windows NT fRf"fsf... [f^, Å, à TCP/IP fvfŠf" f^, ðì, , , é, ±, Æ, á, Å, «, Ü, , B

**TCP/IP ^óü, ð, ½, B, É Windows NT fRf"fsf... [f^, ðì, , , é, É, Í**

1. fRf"fgf [f< fpf<, Å [flfbfgf [fN] , ðf\_fuf<fNfŠfbfN, µ, Ü, , B [flfbfgf [fN, ÌÝ'è] f\_fCfAfO f {fbfNfX, á\ Ž, , è, ½, ç [flfbfgfE fFfA, Ì'Ç%Á] f {f^f" , ðfNfŠfbfN, µ, Å [flfbfgf [fN flfbfgfE fFfA, Ì'Ç%Á] f\_fCfAfO f {fbfNfX, ð•Ž, µ, Ü, ,

2. [flfbfgf [fN flfbfgfE fFfA] ^è—, ©, ç [TCP/IP fvf [fgfRf<, , æ, ÑŠÖ~ AfRf" f [flf"fg] , ð'ì'ð, µ [±s] f {f^f" , ðfNfŠfbfN, µ, Ü, , B

3. [Windows NT TCP/IP 'g, Ýž, ÝflfvfVf#"] f\_fCfAfO f {fbfNfX, Å [TCP/IP flfbfgf [fN ^óüúTf| [fg] f^ fFfbfN f {fbfNfX, ðflf" , É, µ, Ü, , B

Microsoft TCP/IP , á, Ü, ¾fRf"fsf... [f^, É'g, Ýž, Ü, è, Å, ç, È, çèè, ÍA, » , Ì, Ü, ©, Ì•K—v, Èf^ fFfbfN f {fbfNfX, ðflf" , É, µ, Ü, , B

4. [±s] f {f^f" , ðfNfŠfbfN, µ, Ü, , B Windows NT fZfbfgfAfbfv, ÍA Windows NT Server "z•zftf@fCf<, Ö, Ìftf< fpfX, ð, ½, , , È, é [fbfZ [fW, ð•Ž, µ, Ü, , B "KØ, ÈfpfX, ð"ü—, µ [±s] f {f^f" , ðfNfŠfbfN, µ, Ü, ,

•K—v, Èftf@fCf<, á, , x, Äfn [fh fffBfXfN, ÉfRfs [ , , è, Ü, , B

5. [Windows NT TCP/IP 'g, Ýž, ÝflfvfVf#"] f\_fCfAfO f {fbfNfX, Å [DHCP Ž©" @ì, ð—LCEø, É, , é] f^ fFfbfN f {fbfNfX, ðflf" , É, µ, Å, ç, È, çèè, ÍA TCP/IP , Ìžè" @ì, Ìžèè, ð, , x, ÄŽÀs, , é•K—v, á, , è, Ü, , B

TCP/IP , Ìì, , á, µ, ½æä, É [flfbfgf [fN, ÌÝ'è] f\_fCfAfO f {fbfNfX, á"Ä" x•Ž, , è, ½, ç [—] f {f^f" , ðfNfŠfbfN, µ, Ü, , B •ÌX" à—e, ÍA fRf"fsf... [f^, ð"Ä<N" @ , , é, Æ—LCEø, É, È, è, Ü, , B

, ±, è, ÅA, ±, Ì Windows NT fRf"fsf... [f^è, É TCP/IP fvfŠf" f^, ðì, , , é, ±, Æ, á, Å, «, Ü, , B

ŠÖ~A€—Ú

TCP/IP , ðì, , , é

Microsoft TCP/IP , Æ SNMP , Ì'g, Ýž, Ý, Æì



## TCP/IP ^óü,ì,½,ß,Évfšf“f^,ðìí-,·,é

TCP/IP fvfšf“f^,í□Afvfšf“fg f}f□[fWff,ðžg,ç□AWindows NT

flfbfgf□□[fN,Åžg,í,é,éfvfšf“f^,ðìí-,·,é,ì,Æ““,¶•ù-@,Åìí-,·,é,±,Æ,ª,Å,«,Ü,·□BTCP/IP

fvfšf“f^,ðìí-,·,é,É,í□AZÿ,ì,æ,æ,Èî•ñ,ª•K-v,Å,·□B



fvfšf“f^,ª□Ú±,³,é,Ä,ç,ézfxf,ì IP Ž•Éžq□BDNS -¼,© IP fAfhfçfx,ì,ç,·,é,©,Å,·□B¼□Ú□Ú±,³,é,½fvfšf“f^,í□AÆž©,ì IP Ž•Éžq,ðž□,Å,Ä,ç,Ü,·□BUNIX fRf“fsf...□[f^,É□Ú±,³,é,Ä,ç,éfvfšf“f^,ì□è□±,í□Afrf“fsf...□[f^,ì IP Ž•Éžq,ª•K-v,Å,·□B

‘□ : HP JetDirect f□[fh,ðžg-p,·,é¼□Ú□Ú±,³,é,½fvfšf“f^,í□ATCP/IP ^óü,ì LPD ,ðftfj

□[fg,·,éj□[fh,ðž□,Å,Ä,ç,È,·,é,ì,È,è,Ü,¹,ñ□B



fzxfxfg□ã,Åž•É,³,é,éfvfšf“f^-¼□B

TCP/IP fvfšf“f^,ðìí-,·,éRf“fsf...□[f^,É,í□ATCP/IP ,ð,·,ç,©,¶,ß’g,Ýž,ñ,Å,“,«□A[TCP/IP ^óü]

flfvfVfj““,ðžg,Å,Ä□□-,ð□s,Å,Ä,“,•K-v,ª,·,è,Ü,·□B

## TCP/IP fvfšf“f^,ðìí-,·,é,É,í

- fvfšf“fg f}f□[fWff,Å□A[fvfšf“f^] f□fj...□[,ì [fvfšf“f^,ì□□-] fRf}f“fh,ð’ì,Ñ,Ü,·□B
- [fvfšf“f^,ì□□-] f\_fCfAf□fO f{fbfNfX,ì [fvfšf“f^-¼] f{fbfNfX,É□Afvfšf“f^-¼,ð“ü-í,µ,Ü,· (“¼šp,Å 32 •¶žš,Ü,Å)□B,±,ìfvfšf“f^-¼,í□Afvfšf“f^ fEfBf“fhfE,ìf^fCgfç fo□[,É•žì,³,é,Ü,·□B,±,ìfvfšf“f^,ª Windows NT ft□[fU□[,ìšÖ,Å<æ-L,³,é,é□è□±,í□Afvfšf“f^,Ö,ì□Ú±žž,É,±,ìfvfšf“f^-¼,ª•žì,³,é,Ü,·□B
- [fhf%ofCfo] ^è—,©,ç“K□Ø,Èfhf%ofCfo,ð’ì’ð,µ□A,±,ìfvfšf“f^,É,Ä,ç,Äflfbfgf□□[fN ft□[fU□[,É’É’m,·,é•¶žš-ñ,ð □[à-¼] f{fbfNfX,É“ü-í,µ,Ü,·□B,±,ì)•¶žš-ñ“ü-í,í□è—ª%Å“\,Å,·□B
- [^óü□æ] ^è—,©,ç [,»,ì¼], ð’ì’ð,µ,Ü,·□B
- [^óü□æ] f\_fCfAf□fO f{fbfNfX,Å□A[LPR Port] ,ð’ì’ð,µ□A[OK] f{f^f“,ðfNfšfbfN,µ,Ü,·□B
- [LPR çÉš·fvfšf“f^,ì’ç%oÁ] f\_fCfAf□fO f{fbfNfX,ì [LPD ,ð’ñ<ÿ,µ,Ä,ç,ézfxf,ì-¼’O,Ü,½,ìfAfhfçfx] f{fbfNfX,É□A’ç%oÁ,·,éfvfšf“f^,ìzfxf,ì DNS -¼,Ü,½,ì IP fAfhfçfx,ð“ü-í,µ,Ü,·□B  
·,±,ì,É,í□A¼□Ú□Ú±,³,é,½ TCP/IP fvfšf“f^,Ü,½,ìfvfšf“f^,ª□Ú±,³,é,Ä,ç,é UNIX fRf“fsf...□[f^,ì DNS -¼,Ü,½,ì IP fAfhfçfx,ð“ü-í,Å,«,Ü,·□BDNS -¼,É,í□AHOSTS ftf@fCf<“à,Å,»,ìzfxf,É’í,µ,Äžw’è,³,é,Ä,ç,éRf“fsf...□[f^-¼,ð“ü-í,Å,«,Ü,·□B
- LPR ,í□Afvfšf“f^ fvfšf“fefBf“fo ft□[fefBfšfefB (Line Printing utility) ,ð^Ó-i,µ□ALPD ,í□Afvfšf“f^ fvfšf“fefBf“fo ff□[f,· (Line Printing Daemon) ,ð^Ó-i,µ,Ü,·□BUNIX □ã,Å,±,è,ç,ì-v’f,ª,ç,ì,æ,æ ,Éž•É,³,é,é,©,ðžì,µ,Ä,ç,Ü,·□B
- [fRf“fsf...□[f^,ìfvfšf“f^-¼] f{fbfNfX,É□Afvfšf“f^,ªž•É,µ,Ä,ç,éfvfšf“f^-¼,ð“ü-í,µ,Ü,·□Bzfxf,Æ,í□A¼□Ú□Ú±,³,é,½fvfšf“f^ž©’ì,©□AUNIX fRf“fsf...□[f^,Å,·□B  
·,½,Æ,ì,í□A□□-t,ì TCP/IP fvfšf“f^,Æ’šçÉy□-p,·,éfvfšf“fg ft□[fo□[□□-v’f (lpd) ,ðžÀ□s,·,é UNIX fRf“fsf...□[f^,ªflfbfgf□□[fN□ã,É’¶□ÿ,·,é,à,ì,Æ,µ,Ü,·□Blpd ,ª□AUNIX fRf“fsf...□[f^,É□Ú±,³,é,½fvfšf“f^,ì-¼’O,ð Crisp ,Æ,µ,Ä”Fž“,µ,Ä,ç,é□è□±□A,±,ìf{fbfNfX,É“ü-í,·,é-¼’O,ì Crisp ,Å,·□B
- [fvfšf“f^,ì□□-] f\_fCfAf□fO f{fbfNfX,ª□A“x•žì,³,é,Ü,·□B,± ,ìfvfšf“f^,ÉfAfnfzfx,·,é,Ü,©,ìft□[fU□[,ì,½,ß,ìfvfšf“fg ft□[fo□[,Æ,µ,Ä<@“\,·,é Windows NT fRf“fsf... □[f^□ã,Å□Afvfšf“f^,ì<æ-L,ª’è< ,³,é,Ä,ç,é□è□±,í□A[flfbfgf□□[fN□ã,Å<æ-L] f^fffbfN f{fbfNfX,ðfj“,É,µ,Ü,·□B

9. fvfŠf“f^ f}f|[]fWff,í[]AffffHf<fg,Á[]A[<α—L-¼] f{fbfNfX,É MS-DOS fx[]fX,lfRf“fsf...  
 []f^,ÆCEÝŠ·[]«,ª, ,é<α—LŽ‘CE¹-¼,ð[]-μ,Û,·[]B,±,ì-¼‘O,í·Ò[]W,·,é,±  
 ,Æ,ª,Á,«[]Aflfbfgf[][]fNä,Á,±,lfvfŠf“f^,ðŽQ[]Æ,·,é,Æ,«·\Ž!,ª,è,Û,·[]B
10. []Ý‘u[]ê[]Š] f{fbfNfX,É[]AfvfŠf“f^,ì[]Ý‘u[]ê[]Š,ð“ü—í,Á,«,Û,·[]B,±,ì“ü—í,í[]È—ª%oÂ“\  
 ,Á,·[]Bft[]fU[][,í,±,lfvfŠf“f^,É[]Ú‘±,·,é,Æ,«[]A,±,ì[]Ý‘u[]ê[]Š,ì[]·ñ,ðCE©,é,±,Æ,ª,Á,«,Û,·[]B
11. [fvfŠf“f^,ì[]-] f\_fCfAf[]fO f{fbfNfX,ì,Û,©,ì[]-[]-[]·ñ,ð,·,x,ÄŠ®—¹,μ,½CEã[]A[OK]  
 f{f^f“,ðfNfŠfbfN,μ,Û,·[]B[]Ú,μ,,í[]A[]wWindows NT fvXfef€ fKfCfh[]x,ì‘æ 6 []í,ðŽQ[]Æ,μ,Ä,,¾,¾,¾,ç[]B

’[] : **lprmon** ft[]fEfBfŠfefB,ðŽg—p,μ,Ä,ç,é (fvfŠf“f^,ª **lpr** f|[]fG,ðŽg—p,μ,Ä,ç,é)  
 ,Æ,«,í[]A[[]Ú[]×[]Ý‘è] f\_fCfAf[]fO f{fbfNfX,ì [fXfv[]f‘†,ÉfWf#fu,ð^ó[]ü,·,é] flfvfVf#f“,ðŽg,í,È,ç,Á,-  
 ,¾,¾,¾,ç[]B^ó[]üfWf#fu,ªCEø—!“l,É^ó[]ü,μ,Û,¹,ñ[]B

[fvfŠf“f^,ì[]-] f\_fCfAf[]fO f{fbfNfX,ÁŽw‘è,μ,½fvfŠf“f^—¼,í[]AfvfŠf“fg f}f|[]fWff,lfvfŠf“f^  
 fEfBf“fhfE,lf^fCfGf< fo[][,É·\Ž!,ª,è,Û,·[]B,±,ì TCP/IP fvfŠf“f^,É[]Ú‘±,·,éft[]fU[][,í[]A,Û,©,lfvfŠf“f^,Æ“—  
 l,É[]AfvfŠfŠP[]fVf#f“,©,ç,±,lfvfŠf“f^,ð‘ð,μ,Á^ó[]ü,·,é,±,Æ,ª,Á,«,Û,·[]Bft[]fU[][,“æ,ÑŠÇ—  
 []ŽÒ,í[]AfvfŠf“fg f}f|[]fWff,ðŽg,Á,ÁfvfŠf“f^,ìŽg—p,ð·ÛCEì,“æ,ÑŠÄ[],μ[]AfvfŠf“f^,ì[]·ñ,ð·ì[]X,·,é,±  
 ,Æ,ª,Á,«,Û,·[]B

fRf}f“fh fvf[]“fvfg,Á **lpr** []Ú‘±ft[]fEfBfŠfefB,ðŽg,α,±,Æ,É,æ,è[]ALPD fT[]fo[][,ðŽÀ[]s,μ,Ä,ç  
 ,ézfXfg,Éft[]fCf<,ð^ó[]ü,·,é,±,Æ,ª,Á,«,Û,·[]B,Û,½[]Alpq []f’ft[]fEfBfŠfefB,É,æ,è[]ALPD  
 fT[]fo[][,ðŽÀ[]s,μ,Ä,ç,ézfXfg[]ä,ì^ó[]ü‘Ò,¿[]s—ñ,ì[]ó‘Ò,ðŠm”F,·,é,±,Æ,à,Á,«,Û,·[]B

## UNIX fNf%oCfAf“fg, ©, ç Windows NT ,É^óü, ., é

Lpdsvc fT[fxfX, íAUNIX fNf%oCfAf“fg, ì, ½, ß, ìATCP/IP ^óü, ìfT[fo[‘x  
, ìfT[fxfX, Å, ·Bfifbfgf[fNä, ÉAWindows NT fRf“fsf...[f^, ÉÜ’±, ³, ê, ½vfšf“f^, É^óü, μ, ½, ç UNIX fNf  
%oCfAf“fg, á, , éêë, íAUNIX fNf%oCfAf“fg, ©, ç, ì—v<□, ðŽ’ø, Å, «, é, æ, x, ÉA, ±, ìfT[fxfX, ð Windows NT  
fRf“fsf...[f^ä, ÅŽÀs, ., é•K—v, á, , è, Ü, ·BLpdsvc fT[fxfX, íA’P□f, ÈfefLxfXfgE`Ž®, ðŠÜ, ßA, Ç, ì, æ, x  
, É^óüE`Ž®, Å, àfTf[fg, μ, Ü, ·B, Ü, ½A’Ç%oÁ, ì^—□, ðŽÀs, ., é, ±, Æ, í, , è, Ü, ¹, ñ□B

Lpdsvc fT[fxfX, íA^óüfWf#fu, ð Microsoft OS/2 LAN Manager fT[fo[ä, ìfifbfgf[fN<x—L, É, í’—, é, ±  
, Æ, á, Å, «, Ü, ¹, ñ□B

## Windows NT fRf“fsf...[f^ä, Å Lpdsvc fT[fxfX, ðŠŽn, Ü, ½, í’âž~, ., é, É, í



fRf}f“fh fvf“fvfg, ÅAnet start lpdsvc , Ü, ½, í net stop lpdsvc , Æ“ü—í, μAEnter fL[ , ð  
%oÿ, μ, Ü, ·□B  
, , é, ç, íA fRf“fgf□□[f< fpflf<, ì [fT[fxfX] , ðf\_fuf<fNfšfbfN, μ, Ü, ·□BŽÿ, ÉA[fT[fxfX] ^è—, ©, ç  
[Lpdsvc] , ð’í’ð, μA[ŠŽn] f{f^f“ , ðfNfšfbfN, μ, Ü, ·□B

Lpdsvc fT[fxfX, íALprmon fT[fxfX, Æ, í“Æ—š, μ, Å, ç, Ü, ·BLprmon  
fT[fxfX, íAŽ©“®“í, É“®ì, μ, ÅAWindows NT fRf“fsf...[f^ ( , , æ, Ñ, ±, ìfRf“fsf...[f^, ÉfAfNfZfX%oÁ“\, ÈfNf  
%oCfAf“fg, ., x, Ä) , á UNIX fvfXfefe, ÉÜ’±, ³, ê, ½vfšf“f^, É^óü, Å, «, é, æ, x, É, μ, Ü, ·□B

UNIX fRf“fsf...[f^ä, Å, íAlpr ft[feBfšfB, ðŽg, Å, Ä Windows NT , ì^óü’Ò, ùs—ñ, ÈfWf#fu, ð’—, é, ±  
, Æ, á, Å, «, Ü, ·□BUNIX , ì lpr ft[feBfšfB, ìÜ□x, É, Å, ç, Ä, íAUNIX , ì}fjf...fAf<, ðŽQ□Æ, μ, Å, , ¾, ³, ç□B

## TCP/IP `ifconfig` [feBfŠfefB,É,æ,éf%uf<fVf... [feBf“fO

,±,±,Á,í TCP/IP flfbfgf [fN,ì-â'è,ð%ðCE^,; ,é•û-@,ðCE©,Á,¯,é if'fft [feBfŠfefB,ìŽg,ç•û,É,Á,ç,Ä à-¾,µ,Û,· BŽŸ,ì,æ,π,È €-Û,ªŠÛ,Û,è,Ä,ç,Û,· B

 IP `ifconfig` [feBf“fO

 if'fft [feBfŠfefB,ðŽg,π

ft [feBfŠfefB Žg—p•û-@

**arp** f [f]f< fRf“fsf... [f^ [ã,ì ARP (Address Resolution Protocol; fAfhfCEfX %ðCE^ fvf [fgfRf<) fe [fuf<,ð•\ Ž!,µ A C³,Á,«,Û,· B

**hostname** CE» [Ÿ,ìzfXfg,ì-¼' O,ð o—í,µ,Û,· B

**ipconfig** CE» [Ÿ,ì,·,x,Ä,ì TCP/IP flfbfgf [fN [l,ì,ð•Ž!,µ ATP/IP flfbfgf [fN [l,ì,ì,ð X V,Û,½,í%ð•ú,·,é,½,ß,É DHCP fRf}f“fh,ðŽó'ø,µ,Û,· B

**nbtstat** TCP/IP [ã,ì fAfNfefBfu,¯,æ,Ñ-ç^ —,ì NetBIOS flfbfgf [fN“ [CEv [î•ñ,ð'ñ<Ÿ,µ ALMHOS TS flfffbfVf...,ð X V,µ A“o~^— ¼,ÆfXfR [fv ID,ð•Ž!,µ,Û,· B

**netstat** ,·,x,Ä,ì fAfNfefBfu,¯,æ,Ñ-ç^ —,ì TCP/IP [Ú'± ,ì flfbfgf [fN“ [CEv [î•ñ,ð'ñ<Ÿ,µ,Û,· B

**ping** TCP/IP flfbfgf [fN“à,Á TCP/IP fŠf, [fg fVfXfef€,ª— — p,Á,«,é,© A,Û,½,í“K Ø,É<@“\,µ,Ä,ç ,é,©,ç,π,©,ðCE^è,·,é,½,ß,ì'P [ff [ffjfyf€,ð'ñ<Ÿ,µ,Û,· B

## IP `ifconfig` [feBf“fO

fRf“fsf... [f^,É Microsoft TCP/IP ,ð'g,Ÿ [ž,p,Æ,«,É-â'è,ª“ [¶,µ,½ [ê [¶,í AfGf% [ [fbfZ [fW,ìŽwŽ!,É [ ,Á,Ä,,¾,¾,ç B **ping** ft [feBfŠfefB,ðŽg,Á,Ä Af flfbfgf [fN fn [fhfEfFfA,ì-â'è,â [v—,ì CEŸŠ“«,ì-â'è,ð Ø,è•ª,¯ AfŠf, [fg fRf“fsf... [f^ ,Æ,ì• — [l,È [Ú'±,ð CEŸ [ ,·,é,±,Æ,ª,Á,«,Û,· B

fzfXfg,ìzfXfg-¼,Æ IP fAfhfCEfX,ì-¼•û,ð fefXfg,·,é,É,ì A **ping** ft [feBfŠfefB,ðŽg,ç,Û,· B

[•¶,ì [Ú'±,É,Á,ç,Ä,ì AfRf}f“fh fŠftf@fCEf“fX,ì **ping** fRf}f“fh,ðŽ Q [Æ,µ,Ä,,¾,¾,ç BHOSTS ftf@fCf<,ì [Ú'±,É,Á,ç,Ä,ì ALMHOSTS,ì [Ÿ'è,ðŽ Q [Æ,µ,Ä,,¾,¾,ç B

## ping ft [feBfŠfefB,ðŽg,Á,Ä TCP/IP ,ð fefXfg,·,é,É,í

1. fRf“fsf... [f^,ª DHCP ,ðŽg,Á,Ä [v—,¾,è,Á,ç,é [ê [¶,ì A **ipconfig** ,ðŽg,Á,Ä IP fAfhfCEfX,ð“üŽè,µ,Û,· B

2. ping , dŽg, c AfRf}f"fh fvf f"fvfg, Å ping 127.0.0.1 , i, æ, x, É"ü—Í, µ AEnter fL [ , ð %oÿ, µ, Äf< [ fvf ofbfN fAfhfCEfX, ð², x, Ü, · B

fRf"fsf... [f^ , í ; Å, É%ž"š, , é, í, , Å, · B

ping , aCE ©, Å, ©, ç, È, c [ è [ #, âfRf}f"fh, ÌŽÀ [ s, ÈŽ, "s, , é [ è [ #, Í [ AfCxf"fg frf...

[ [ fA, ðŽg, c AfZfbfgfAfbfv, Ü, ½, Í TCP/IP fT [ [ frfX, ©, ç • ñ [ [ , ³, è, Å, ç, é-â'è, ðfCxf"fg f [ fO, Å'T, µ, Ü, · B

3. IP , a³, µ, [ [ - , ³, è, Å, ç, é, ©, Ç, x, ©, ð², x, é, É, Í [ AŽ © • a, }fRf"fsf... [f^ , Ì IP fAfhfCEfX [ A, » , }fRf"fsf...

[ [ f^ , }fftfHf<fg fQ [ [ fgfEfffC [ A, " , æ, ÑfŠf, [ [ fg fzfXfg, ðŽw'è, µ, Å ping , ðŽÀ [ s, µ, Ü, · B

ping , a³ [ í, ÈŽg—p, Å, «, È, c [ è [ #, Í [ AŽÿ, Ì [ ðCE [ , a—ž, ½, ³, è, Å, ç, é, ©, Ç, x, ©, ðŠm" F, µ, Ä, , ¾, ³, c [ B



TCP/IP , Ì'g, Ý [ Ž, Ý, Æ [ [ - , ÌCEä, ÅfRf"fsf... [f^ , ð [ Ä<N" @ , µ, ½ B



f [ [ [ f]f< fRf"fsf... [f^ , Ì IP fAfhfCEfX, a—LCEØ, Å [ A [ TCP/IP , Ì [ [ - ] f\_CfAf [ fO f {fbfNfX, É [ , µ, • \

Ž, Ì, ³, è, é [ B



fftfHf<fg fQ [ [ fgfEfffC , " , æ, ÑfŠf, [ [ fg fzfXfg, Ì IP fAfhfCEfX, a³, µ, c [ B



IP f< [ [ fefBf"fo, a%oÅ" \, Å [ Af< [ [ f^ [ [ [ ŠÖ, }fŠf"fn, a" @ [ Ì%oÅ" \, Å , é [ B

• È, }fTfufjfbfg [ a, Ì Windows NT fRf"fsf... [f^ , É [ Ú'± , , é [ Ú [ Aping , Å, Í [ Ú'±, Å, «, é, a [ Aftf@fCf< f }f [ [ fWff, Ü, ½, Í net use \\server\share , Å, Í [ Ú'±, Å, «, È, c [ è [ #, Í [ AŽÿ, Ì Ž- [ € , É-â'è, a, È, ç, ©, Ç, x , © Šm" F, µ, Ä, , ¾, ³, c [ B



fRf"fsf... [f^ , Å WINS , aŽg—p%oÅ" \ (—LCEØ) , É [ Ý'è, ³, è, Å, ç, é (fjfbfgf [ [ fN, a WINS

fT [ [ fo [ [ , ðŽ [ , Å [ è [ #] [ B



WINS fT [ [ fo [ [ , }fAfhfCEfX, a³, µ, [ AWINS fT [ [ fo [ [ , a< @ " \, µ, Ä, ç, é [ B



[ , µ, çfRf"fsf... [f^ - ¼, ðŽg—p, µ, Ä, ç, é [ B



f^ [ [ fQfbfg fzfXfg, a NetBIOS , ðŽg—p, µ, Ä, ç, é [ BNetBIOS , ðŽg—p, µ, Ä, ç, È, c [ è [ #, Í [ AFTP , Ü, ½, Í Telnet , ðŽg, Å, Å [ Ú'±, µ, È, , è, í, È, è, Ü, ¹, ñ [ B, ±, Ì [ è [ # [ Af^ [ [ fQfbfg fzfXfg, Í [ AFTP fT [ [ fo [ [ ff [ [ f, " , Ü, ½, Í Telnet fT [ [ fo [ [ ff [ [ f, " , Å [ [ - , ³, è, Å, ç, È, , è, í, È, è, Ü, ¹, ñ [ B, Ü, ½ [ Af [ [ fU [ [ , Í [ A, ±, }f^ [ [ fQfbfg fzfXfg, Ó [ Ú'± , , é, ½, ß, í " K [ Ø, ÈfAfNfZfXCE , ðŽ [ , Å, Å, ç, È, , è, í, È, è, Ü, ¹, ñ [ B



f^ [ [ fQfbfg fzfXfg, Æf [ [ [ f]f< fRf"fsf... [f^ , }fXfR [ [ fV ID , a" , ¶, Å , é [ B



Ž © • a, }fVfXfef€, Æf [ [ fQfbfg fVfXfef€, Ì ŠÖ, Èf< [ [ f^ [ [ , a" ¶ [ Ý, , é [ B



fRf"fsf... [f^ - ¼, a%oðCE^ , Å, «, é, æ, x, É [ ALMHOSTS , É [ , µ, çfGf"fgfŠ, a" ü—Í, ³, è, Å, ç, é [ B

IP fAfhfCEfX, Í%ož"š, , é, a fzfXfg-¼, Í%ož"š, µ, È, c [ è [ #, Í [ A-¼' O%oðCE^ , É-â'è, a , è, Ü, · BŽÿ, É [ A-¼' O %oðCE^ , É, " , ç, Å'è"É"Í, ÉCE [ , ç, è, é-â'è" \_ , Æ, » , Í%oðCE^ [ ð, ðŽ [ , µ, Ü, · B

**HOSTS ftf@fCf<, ÉŠÖ~A, , éCEè, è**



HOSTS ftf@fCf<, Ü, ½, Í DNS , É [ A" - , }fzfXfg-¼, ð<L [ Ú, µ, Ä, ç, È, c [ B



HOSTS ftf@fCf<, Ü, ½, }fRf}f"fh"à, }fzfXfg-¼, Ì'Ó, è, ðŠÖ^á, Ì, Å, ç, é, © [ A'á • ¶ Žš, Æ [ - • ¶ Žš, Ì Žg—p, ðŠÖ^á, Ì, Å, ç, é (fzfXfg-¼, È, Í [ A'á • ¶ Žš, Æ [ - • ¶ Žš, Ì<æ • È, a , è, Ü, ·) [ B



HOSTS ftf@fCf<"à, }fzfXfg-¼, É [ A-³CEØ, È IP fAfhfCEfX, ð"ü—Í, µ, Ä, ç, é [ B



HOSTS ftf@fCf< , | • ; [ " , Ì [ s, É [ A" ^ è fzfXfg, }fGf"fgfŠ, ð<L "ü, µ, Ä, ç, é [ B



fRf"fsf... [f^ - ¼, Æ IP fAfhfCEfX, }f}fbfbsf"fo, ð [ AŠÖ^á, Ì, Å (LMHOSTS , Å, Í, È, ) HOSTS ftf@fCf<, É'Ç %oÅ, µ, Ä, ç, é [ B

**LMHOSTS ftf@fCf<, ÉŠÖ~A, , éCEè, è**



LMHOSTS ftf@fCf<, É [ AfŠf, [ [ fg fT [ [ fo [ [ , }fGf"fgfŠ, ð<L [ Ú, µ, Ä, ç, È, c [ B



LMHOSTS ftj@fCf<"à,lfRf"fsf...[f^-¼,ì'Ô,è,đŠÔ^á,!,Ä,ç,é (LMHOSTS -¼,í'â•¶Žš,É•řč,³,ê,é,±  
 ,Æ,É'□^Ó,μ,Ä,,¾,³,φ)□B



LMHOSTS ftj@fCf<"à,lfRf"fsf...[f^-¼,ì IP fAfhfCEfX,ª-³CEø,Å, ,é□B

## ft [fefBfŠfefB,žg,æ

Ú ± ä, ì-à-è " \_ , ðCE © , Á , ¯ , % ðCE ^ , , é , é , í , Aping , É % Á , í , Ä , Anetstat , , æ , Ñ nbtstat , É , Ç , í , ft [fefBfŠfefB,žg,æ,±,Æ,ª,Ä,«,Ü,·B,±,±,Ä,ì-á,íA,·,×,Ä,ì-à-è,ð-Ö-... , , é , à , ì , Ä , í , , è , Ü , ð , ñ , Af fbf g f [fN ä, ì-à-è " \_ , ð " È , « Ž ~ , ß , é , ½ , ß , É A , ± , é , ç , í ft [fefBfŠfefB,ð,Ç,ì,æ,æ,ÉŽg,æ,©,ðŽ,í,µ,Ä,ç,Ü,·B

## ft [fo [ , Ö , ì Ú ± Žž , É Error 53 ,ª" [ , , , é ê ± , í

1. Error 53 , í A " Á ' è , ì Rf " fsf ... [f ^ -¼ , ì -¼ ' O % ðCE ^ ,ªŽ , " s , µ , ½ ê ± , É • Ö ,ª , è , é f Gf % [ f [ fbfz [fW, Ä , · BfRf " fsf ... [f ^ ,ª [f [fj f fuf lfbfg ä , É ^ È ' u , , , é ê ± , í Af ^ [fQfbfg fRf " fsf ... [f ^ -¼ , ì ' Ö , è ,ª [ , µ , Af [fQfbfg fRf " fsf ... [f ^ ,ª TCP/IP , ð Ž Ä s , µ , Ä , ç , é , ± , Æ , ð Š m " F , µ , Ü , · BfRf " fsf ... [f ^ ,ª [f [fj f fuf lfbfg ä , É ^ È ' u , µ , È , ç ê ± , í AfRf " fsf ... [f ^ -¼ , Æ IP fAfhfCEfX, ìf } fbf sf " fO ,ª LMHOSTS ftf@fCf<, Ü, ½, í WINS f [f ^ fX [fX, Ä - - p, Ä, «, é, ±, Æ, ð Š m " F, µ, Ü, · B
2. TCP/IP [ \ - - v ' f ,ª , , × , Ä [ , µ , ' g , Ý ç , Ü , è , Ä , ç , é , Æ Ž v , í , è , é ê ± , í AfŠf , [fg fRf " fsf ... [f ^ , Ä ping , ð Ž g , Ä , Ä TCP/IP f ftf g f E f f A ,ª " @ [ , µ , Ä , ç , é , ± , Æ , ð Š m " F, µ , Ü , · B

## LMHOSTS 'Ç % Á CE ä , É Ú ± Žž Š Ö ,ª" , , È , Ä , ½ ê ± , í



± , ì-à-è , í Af tf @ fCf < , í , í , è , É f Gf " fgf Š ,ª , , é ä , « , ç LMHOSTS ftf@fCf<, Ä < N , ± , é % Á " [ < ,ª , , è , Ü , · Bf } fbf sf " fO , í CE ä , è , É #PRE f ^ fO , ð • t , ¯ , Ä ALMHOSTS , ì f Gf " fgf Š , ð , , ç , © , [ , ß f [f h , , é f Gf " fgf Š , Æ , µ , Ä f } [fN , µ , Ü , · B Ž Ý , É Anbtstat -R fRf } f " fh , ð Ž g , Ä , Ä f [fj f < -¼ f l f f f b f v f ... , ð , , , @ , É X [ V , µ , Ü , · B , Ü , ½ , í Af } fbf sf " fO , ð LMHOSTS ftf@fCf<, ì ' O , ì • ù , É ^ Ú " @ , µ , Ü , · B LMHOSTS ftf@fCf<, í [ Ž Ý % ð í ,ª , è A #PRE fL [f [f [f h , ì , è , ç f Gf " fgf Š ,ª ^ È ' u • t , ¯ , ç , è , Ü , · B , µ , ½ ,ª , Ä , Ä A • p " É , É Ž g , í , è , é f Gf " fgf Š , í Af tf @ fCf < , ì ' O , ì • ù , É < L [ Ü , µ [ A , » , ì #PRE fGf " fgf Š , ð f tf @ fCf < , í , è , ì • ù , É < L [ Ü , µ , Ä , , , æ , æ , É , µ , Ü , · B

## ft [fo [ -¼ Žw ' è Žž , É Ú ± , ì-à-è ,ª" [ , , , é ê ± , í



nbtstat -n fRf } f " fh , ð Ž g , Ä , Ä A , » , í ft [fo [ ,ª f lfbfg f [fN , É " o ~ ^ , µ , Ä , ç , é -¼ ' O , ð Š m " F , µ , Ü , · B , ± , ì fRf } f " fh , í o - í , É , í A , ± , ì fRf " fsf ... [f ^ ,ª " o ~ ^ , µ , Ä , ç , é -¼ ' O ,ª , ç , , Ä , © ^ è - - ,ª , è , Ä , ç , Ü , · B , ± , ì ' t , É A , ± , ì fRf " fsf ... [f ^ , ì -¼ ' O , É Ž - , Ä , ç , é -¼ ' O ,ª " [ Ý , , é , í , , Ä , · B " [ Ý , µ , È , ç ê ± , í Anbtstat , Ä \ Ž , ð ,ª , è , ½ ^ è ' Ö , ì -¼ ' O , ì ' t , ì 1 , Ä , ð Ž Ž , µ , Ä , Ý , Ü , · B nbtstat ft [fefBfŠfefB,žg,æ,Ä,AfLfffbfvf... É " ü , è , ç , è , ½ f Šf , [fg fRf " fsf ... [f ^ , É ' í , , é f Gf " fgf Š , ð \ Ž , ð , , é , ± , Æ , à , Ä , « , Ü , · B fLfffbfvf... É " ü , è , ç , è , Ä , ç , é , ì , í ALMHOSTS " à , ì #PRE fGf " fgf Š , © [ A Ä < ß % ðCE ^ ,ª , è , ½ -¼ ' O , Ä , · B • í [ , ì Šf , [fg fRf " fsf ... [f ^ ,ª , » , í ft [fo [ , É ' í , µ , Ä Ž g - p , µ , Ä , ç , é -¼ ' O ,ª " ^ è , Ä , , è AfŠf , [fg fRf " fsf ... [f ^ ,ª , , é ê ± , í A , » , è , ç , ì fRf " fsf ... [f ^ , ì LMHOSTS ftf@fCf< " à , ì fRf " fsf ... [f ^ , ìf } fbf sf " fO ,ª " , [ , à , ì , Ä , , é , ± , Æ , ð Š m " F , µ , Ä , ,ª , ç , ç [ B

## ^ Žž í fVxfefE, Ö , ì Ú ± , É AIP fAfhfCEfX, ¾ , ¯ ,ª @ " \ , µ AfzfXfg -¼ ,ª @ " \ , µ , È , ç ê ± , í

1. fRf " fgf [f < f p f l f < , ì [f lfbfg f [fN] , ð Ž g , ç [A [TCP/IP , ì [ - ] f , fCf Af [fO f {f b f N f X , Ä [A [DNS] f {f ^ f " , ð f N f Š f b f N , µ , Ü , · B f z f X f g -¼ % ðCE ^ , ì [ - , ð '² , × AfRf " fsf ... [f ^ , É ' í , µ , Ä " K [ Ø , È HOSTS ftf@fCf<, Æ DNS [Ý ' è ,ª [ - ,ª , è , Ä , ç , é , ± , Æ , ð Š m " F, µ, Ü, · B
2. HOSTS ftf@fCf<, ð Ž g , Ä , Ä , ç , é ê ± , í AHOSTS ftf@fCf<, Æ , » , è , ð Ž g - p , µ , Ä , ç , é f AfvfŠfP [fVf# " , Ä AfŠf , [fg fRf " fsf ... [f ^ -¼ , ì ' Ö , è , , æ , Ñ ' ä • [ Žž , Æ [ - • [ Žž ,ª " , [ , É , È , Ä , Ä , ç , é , ± , Æ , ð Š m " F, µ, Ü, · B
3. DNS , ð Ž g , Ä , Ä , ç , é ê ± , í ADNS ft [fo [ , ì IP fAfhfCEfX,ª [ , µ , Ä " K [ Ø , È [ # ~ , É , È , Ä , Ä , ç , é , ± , Æ , ð Š m " F, µ, Ü, · BfŠf , [fg fRf " fsf ... [f ^ , Ä Aping , É f z f X f g -¼ , Æ IP fAfhfCEfX, ì -¼ • ù , ð Ž w ' è , µ , Ä " ü - í , µ , Ä AfzfXfg -¼ ,ª [ , µ , % ðCE ^ ,ª , è , é , © , ç , x , © , ð Š m " F, µ, Ü, · B

## fŠf , [fg fRf " fsf ... [f ^ , Ö , ì TCP/IP Ú ± ,ª [ , µ , " @ [ , µ , È , ç ê ± , í



netstat -a fRf } f " fh , ð Ž g , Ä , Ä Af [fj f fRf " fsf ... [f ^ ä , ì TCP f [fg , Æ UDP f [

□[fg,ì,·,x,Ä,ìŠ“^@□ó<μ,δ•Ž!,μ,Ü,·□B  
□³,μ,¢ TCP □U±,ì□ó'Ò,ì□A'É□í□A'—□M'Ò,ì□s—ñ,ÆŽó□M'Ò,ì□s—ñ“à,ª 0 fofCfg,ì□ó'Ò,ÄŠm—  
š,ª,è,Ü,·□B,Ç,ì,ç,©,ì'Ò,ì□s—ñ“à,Äff□[f^,ªfuf□fbfN,ª,è,Ä,¢,é,©□A□ó'Ò,ª•s<K'¥,É□é□±,ì□A□U±,É—à'è,ª, ,é  
%oÄ“□«ª, ,è,Ü,·□B,±,è,ç,ª“—,Ä,ì,Ü,ç,É, ,è,ì□Aflfbfgf□□[fN'x%o,,,©fAfvfšP□[fVf#“x%o,,,ì%oÄ“□«ª, ,è,Ü,·□B

### FTP fT□[fo□[ fT□[frfX,ª□³,μ,‘g,Ý□ž,Ü,è,Ä,¢,é,©,Ç,¤,©Šm”F,·,é,É,Í



f□□[fjf< fRf“fsf...□[f^□ä,Ä□Afrf}f“fh f%ofCf“,Ä ftp ,É IP f<□[fvf□fbfN fAfhfCefX,ðžw'è,μ,Ä“ü—  
í,μ,Ü,·□B,±,è,ð□s,¤,É,ì□Aftp 127.0.0.1 ,Æ“ü—í,μ□AEnter fL□[,ð%Ý,μ,Ü,·□B  
fT□[fo□[,Æ,ìf□□[fjf<,É□s,ª'í~b□^—□,ì□A,Ü,©,ì Windows NT fNf%ofCfA“fg (, ,æ,Ñ“á”¼,ì UNIX fNf  
%ofCfA“fg) ,Æ□s,ª'í~b□^—□,Æ“~è,Ä,·□B,±  
,ìft□[fefBšFefB,ì□AfffBšFefNfgš□A“fNfzFXCE □A,»,ì,Ü,©,ª□AFTP fT□[fo□[ fT□[frfX,É'í,μ,Ä“K□Ø,É□  
□-,ª,è,Ä,¢,é,©,Ç,¤,©,ðŠm”F,·,é,½,š,Éžg,¤,±,Æ,à,Ä,«„Ü,·□B

### □³,μ,¢ IP fAfhfCefX,ðžw'è,μ,Ä,à□ATelnet ,Ä,Ü,©,ìfRf“fsf...□[f^,ªfofi□[•¶žš,Ä•Ž!,ª,è,é□é□±,Í

1. DNS -¼, ,æ,ÑfzfXfg fe□[fuf<,ª□A□V,ì,à,ì,É□X□V,ª,è,Ä,¢,é,±,Æ,ðŠm”F,μ,Ü,·□B
2. “,¶flfbfgf□□[fN□ä,ì 2 ,Ä,ìfRf“fsf...□[f^,É□AŠÓ^á,ì,Ä“~,¶ IP fAfhfCefX,ðš,,,è“—,Ä,Ä,¢,È,ç,©,Ç,¤, ,©,ðŠm”F,μ,Ü,·□B

f□□[fTfjfbfg,Æ IP fAfhfCefX,ìf}fbfsf“fo,ì□AARP (Address Resolution Protocol; fAfhfCefX  
%oðCE^fvf□fgfRf<) f,fwf...□[f<,ªžÄ□s,μ□AARP ,ì□A□A□%o,Éžó□M, ,é%ož“š,ð□M—  
p,μ,Ü,·□B,»è,Ä□A<U,ìfRf“fsf...□[f^,ì%ož“š,ª□A—U“ì,ìfRf“fsf...□[f^,ì%ož“š,æ,è,à□,•Ö,Ä,Ä,é,±,Æ,ª, ,è  
,Ü,·□B

,±,ìž!,ì—à'è,ì□Ø,è•ª, ,à'ç□Ø,ì□c“i,Ä,·□Barp -g fRf}f“fh,ðžg,Ä,Ä□AARP fLfffbfvf...“à,ìf}fbfsf“fo,ð•\  
Ž!,μ,Ü,·□B—U“ì,ìšš,□[fg fRf“fsf...□[f^,ìfC□[fTfjfbfg fAfhfCefX,ð'm,Ä,Ä,¢,é□é□±,ì□A,±,è,ç 2 ,Ä,ì  
%ož“š,ª“~,¶,©,Ç,¤,©ŠE'P,ÉŠm”F,Ä,«„Ü,·□BfC□[fTfjfbfg fAfhfCefX,ª•ª,©,ç,È,ç□é□±,ì□Aarp -d ,ðžg—  
p,μ,ÄfGf“fgfš,ð□í□œ,μ,Ü,·□Bžž,É□Aping ,É“~,¶fAfhfCefX,ðžw'è,μ (ARP ,ð<□š, ,é)□Aarp -g  
,ðžg,Ä,ÄfLfffbfvf...“à,ìfC□[fTfjfbfg fAfhfCefX,ð,à,ª^è“x'², x,Ü,·□B

—¼•ù,ìfRf“fsf...□[f^,ª“~,¶flfbfgf□□[fN□ä,É'¶□Ý,μ,Ä,¢,é□é□±,ì□A<<Ç□A^Ü,È,é%ož“š,ðžó,~žæ,é  
%oÄ“□«ª, ,è,Ü,·□B—¼•ù,ìfRf“fsf...□[f^,ª“~,¶flfbfgf□□[fN□ä,É'¶□Ý,μ,Ä,¢  
,È,ç□é□±,ì□A<UfzfXfg,©,ç,ìfgf%ofTfBfbfN,ÉftfBf<f^,ð,©, , ,Ä□AfvfXfef€,ì□š—  
LžÖ,Ü,½,ì^É'u,ð“È,«ž~ ,š,é•K—v,ª, ,è,Ü,·□B

### fZfbfgfAfbfv't,É□gffftfHf<fg fQ□[fgfEfFfC,ª□Ý'è,μ,½fCf“f^□[ftfFfCfX,ì,¢ , ,è,É,à'©,μ,Ü,¹,ñ□B□h,Æ,¢,¤f□fbfZ□[fW,ª•\Ž!,ª,è,é□é□±,Í



ffftfHf<fg fQ□[fgfEfFfC,ì IP fAfhfCefX,ìfjfbfgf□□[fN ID •”ª,Æ□Afrf“fsf...□[f^,ì“C^Ó,ìfjfbfgf□□[fN  
fAf\_fvf^,ìfjfbfgf□□[fN ID ,ð“ä, x, Ä□AfffftHf<fg fQ□[fgfEfFfC,ÆfRf“fsf...□[f^,ìfjfbfgf□□[fN fAf\_fvf^,ª“~,¶—  
□fjfbfgf□□[fN□ä,É^É'u,μ,Ä,¢,é,©,Ç,¤,©,ðŠm”F,μ,Ü,·□B  
,½,Æ,ì,ì□Afrf“fsf...□[f^,Éfjfbfgf□□[fN fAf\_fvf^,ª 1 ,Ä'•...ª,è,Ä, ,è□A,±,ìfAf\_fvf^,ì IP fAfhfCefX,ª  
102.54.0.1□Aftfufjfbfg f}fXfN,ª 255.255.0.0 ,É□\□-,ª,è,Ä,¢,é□é□±,ì□AIP fCf“f^□[ftfFfCfX,ìfjfbfgf□□[fN ID  
•”ª,ª 102.54 ,É,ì,Ä□AfffftHf<fg fQ□[fgfEfFfC,ì 102.54.a.b ,ìCE žž,É,É,é•K—v,ª, ,è,Ü,·□B□U□x,É,Ä,¢  
,Ä,ì□AIP fAfhfCefXžw'è,ðžQ□Æ,μ,Ä,,¾,ª,ç□B

### TCP/IP ff□[f^fx□[fx ftf@fCf<,ìfgf%ofuf<fvf...□[fefBf“fo

žž,ì UNIX fXf^fCf<,ìff□[f^fx□[fx ftf@fCf<,ì□AMicrosoft TCP/IP ,ð'g,Ý□ž,p,Æ,«□A\systemroot\SYSTEM32\  
DRIVERS\ETC ,Éšì“[,ª,è,Ü,·□B

### HOSTS

Windows Sockets fAfvfšP□[fVf#“ ,ì,½,š,É□AfvfXfg-¼,©,ç IP fAfhfCefX,Ö,ì%oðCE^ ,ð'ñ<Ý,μ,Ü,·□B

### LMHOSTS



Windows f1fbfgf[][]fN, ð, ½, ß, É[]ANetBIOS -¼, ©, ç IP fAfhfÇfX, Ö, ð%øðCE^, ð'ñ<ÿ, µ, Ü, ·[]B

**NETWORKS**

TCP/IP , ðŠÇ—[], ð, ½, ß, É[]Af1fbfgf[][]fN-¼, ©, çf1fbfgf[][]fN ID , Ö, ð%øðCE^, ð'ñ<ÿ, µ, Ü, ·[]B

**PROTOCOLS**

Windows Sockets fAfvfŠfP[][]fVf#f", ð, ½, ß, É[]Afvf[]fgfRf<-¼, ©, çfvf[]fgfRf< ID , Ö, ð%øðCE^, ð'ñ<ÿ, µ, Ü, ·[]B

**SERVICES**

Windows Sockets fAfvfŠfP[][]fVf#f", ð, ½, ß, É[]AfT[][]fX-¼, ©, çf[][]fg ID , Ö, ð%øðCE^, ð'ñ<ÿ, µ, Ü, ·[]B

f[][]fjfk fRf"fsf...[]f^[]ã, ð, ±, ê, ç, ðftf@fCf<, ðfgf%øfuf<, É'í%øž, ·, é, É, í[]AZÿ, ð[]€-Ú, ðŠm" F, µ, Ü, ·[]B



Šeftf@fCf<"à, ðfGf"fgfŠ, ðCE`Ž®, æ[]AMicrosoft TCP/IP , Æ, ç, Á, µ, å, É'g, Ÿ[]ž, Ü, ê, ½f1fŠfWfjfk fTf"fvf< ftf@fCf<, ðCE`Ž®, Æ"- , ¶, ©, Ç, æ, ©, ðŠm" F, µ, Ü, ·[]B



'Ö, è, Ü, ½, í'å•¶žš[]-•¶žš, ð<æ•É, æ[]³, µ, ç, ©'², x, Ü, ·[]B



-³CEø, È IP fAfhfÇfX, ", æ, ÑŽ- •Éžq, æžg, í, ê, Ä, ç, È, ç, ©'², x, Ü, ·[]B

## Windows NT ,ì MIB flfufWfFfNfg

LAN Manager MIB II for Windows NT ,É,íAWindows NT ,ðŽÀs, ,éRf“fsf...[]f^ ,ðfTf}  
[]fg, ,é,½,ß,É“Á•É,ÉYCEv,³,é,½flfufWfFfNfg,ìW[]+“ì,³ŠÜ,Ü,é,Ä,ç,Ü,·B,±,±,Ä,íAMIB ,ìflfufWfFfNfg,ì^è  
—,ðŽì,μAŠÈ‘P,Èà-¾,ð%Á,ì,Ä,ç,Ü,·BflfyfCE[]fefBf“fO fVfXfef€,ì^á,ç,É,æ,èALAN Manager MIB II  
for Windows NT ,ìflfufWfFfNfg,íALAN Manager MIB II for OS/2 ,ìflfufWfFfNfg,É“ä,x,Ä[]”,³,È,ç,±  
,Æ,É^‘Ó,μ,Ä,,¾,³,çB,±,é,ç,ìflfufWfFfNfg,ì,·,x,ÄAWindows NT Workstation , ,æ,Ñ Windows NT Server  
,É“K—p,³,é,Ü,·B

DHCP , ,æ,Ñ WINS fT[]fo[]l,ì MIB flfufWfFfNfg,à’ñ<ÿ,³,é,Ü,·B

Žÿ,ì,æ,x,È MIB flfufWfFfNfg,É,Ä,ç,Äà-¾,μ,Ü,·B



<æ’ÉfOf<[]fv



fT[]fo[]l fOf<[]fv



f[][]fNfXfef[]fVf#f“ fOf<[]fv



fhf[]Cf“ fOf<[]fv



DHCP flfufWfFfNfg



WINS flfufWfFfNfg

,±,±,Ä,ìà-¾,íA“ÇŽÖ,³flfbfgf[][]fNŠÇ—[]ATCP/IPA, ,æ,Ñ SNMP ,ð—[]%ð,μ,Ä,ç,é,±,ÆA, ,æ,Ñ MIB  
(Management Information Base; ŠÇ—[]î•ñfx[]fX) ,É[] ,’É,μ,Ä,ç,é,±,Æ,ð’O’ñ,Æ,μ,Ä,ç,Ü,·BTCPIP ,Ü,½,í  
Internet MIB II ,ÉŠÖ, ,é’mŽ~ ,³[]\•³,Ä,È,ç,ÆŽv,í,é,éèè# ,íA[]wInternetworking with TCP/IP[]x(Douglas E.  
Comer, Prentice Hall, 1991)[]A[]wThe Simple Book[]x(Marshall T. Rose, Prentice Hall, 1991)  
,É,Ç,ðŽQ[]Æ,μ,Ä,,¾,³,çB

<#’ÉfOf<[]fv

**comVersionMaj {common 1}**

Windows NT f\ftfgfEjFfA,ìžáfšš[]fX fo[]fWf#f””Ô+[]B

**comVersionMin {common 2}**

Windows NT f\ftfgfEjFfA,ìf}fCfi fšš[]fX fo[]fWf#f””Ô+[]B

**comType {common 3}**

,±,ìfvXfjef€,ÁžÀ[]s’t,ì Windows NT f\ftfgfEjFfA,ìží—þ[]B

**comStatStart {common 4}**

1970 "N 1 CEŽ 1 "ú 00:00:01 AM ,©,ç[]A,±,ìfm[]fh[]ă,ì Windows NT  
"[]CEv[]î•ñ,ª[]ÁCEă,É[]Á<ž,³,ê,½žž“\_Ü,Á,ìCEo%oßžžššÔ (•b’P^É)[]BcomStatStart  
f\fuWfFfNfg,í[]AZÿ,ì"[]CEv[]î•ñf\fuWfFfNfg,É“K—p,³,ê,Ü,·[]B

<b>comStatNumNetIOs</b>	<b>svStatErrorOuts</b>	<b>wkstaStatSessStarts</b>
<b>comStatFiNetIOs</b>	<b>svStatPwErrors</b>	<b>wkstaStatSessFails</b>
<b>comStatFcNetIOs</b>	<b>svStatPermErrors</b>	<b>wkstaStatUses</b>
<b>svStatOpens</b>	<b>svStatSysErrors</b>	<b>wkstaStatUseFails</b>
<b>svStatDevOpens</b>	<b>svStatSentBytes</b>	<b>wkstaStatAutoRecs</b>
<b>svStatJobsQueued</b>	<b>svStatRcvdBytes</b>	
<b>svStatSOpens</b>	<b>svStatAvResponse</b>	

**comStatNumNetIOs {common 5}**

,±,ìfm[]fh[]ă,Á"[]¶,μ,½f\fbfgf[][]fN I/O ‘€[]i,ì[]”[]B

**comStatFiNetIOs {common 6}**

,±,ìfm[]fh[]ă,Á"[]s,Éž,“s,μ,½f\fbfgf[][]fN I/O ‘€[]i,ì[]”[]B

**comStatFcNetIOs {common 7}**

,±,ìfm[]fh[]ă,Áš@—¹,Éž,“s,μ,½f\fbfgf[][]fN I/O ‘€[]i,ì[]”[]B

,Ü,©,ì"[]CEv[]î•ñf\fuWfFfNfg,É,Á,ç,Ä,í[]A,»,ê,ç,ª[]š‘@,·,éfOf<[]fv,Á[]à-¾,μ,Ü,·[]B

**fT[fO[fJ**

**svDescription {server 1}**

fT[fO[f[.É.Â.ç.Ä.Lq.µ.½fRf“fgB

**svSvcNumber {server 2}**

fT[fO[f[.É'g.Ýž.Ü.ê.Ä.ç.élfbfqf[fN fT[frfX.ì”B

**svSvcTable {server 3}**

fT[fO[f[.É'g.Ýž.Ü.ê.Ä.ç.élfbfqf[fN fT[frfX.É.Â.ç.Ä.Lq.µ.½fT[frfX fGf“fgfŠ.ì^ê—B

**svSvcEntry {svSvcTable 1}**

fT[fO[f[.É'g.Ýž.Ü.ê.Ä.ç.élfbfqf[fN fT[frfX.ì-¼'O B

**svSvcName {svSvcEntry 1}**

Windows NT flbfqf[fN fT[frfX.ì-¼'O B

**svSvcInstalledState {svSvcEntry 2}**

flbfqf[fN.ì'g.Ýž.Ýó'Ô B

**svSvcOperatingState {svSvcEntry 3}**

flbfqf[fN fT[frfX.ì“@ìó'Ô B

**svSvcCanBeUninstalled {svSvcEntry 4}**

.±.lfGf“fgfŠ.Ăžw'è.µ.½flbfqf[fN fT[frfX.ðíœ.Ă.«.é.©.Ç.κ.©.ðŽ.µ.Ü.· B

**svSvcCanBePaused {svSvcEntry 5}**

.±.lfGf“fgfŠ.Ăžw'è.µ.½flbfqf[fN fT[frfX.ð^êžž'âž~.Ă.«.é.©.Ç.κ.©.ðŽ.µ.Ü.· B

**svStatsOpen {server 4}**

fT[fO[f[ä.ĂŠ.©.é.½ftf@fCf<.ì”B

**svStatDevOpens {server 5}**

fT[fO[f[ä.ĂŠ.©.é.½'ÊMffofCfX.ì”B

**svStatQueuedJobs {server 6}**

fT[fO[f[ä.ĂfXfv[f<.³.é.½^óüfWf#fu.ì”B

**svStatSOpens {server 7}**

fT[fO[f[ä.ĂN“@.³.é.½fZfbfVf#f“.ì”B

**svStatErrorOuts {server 8}**

fT[fO[f[ä.ĂfGf%o[f.³”f.µ.½.½.B.ÉØ'f.³.é.½fZfbfVf#f“.ì”B

**svStatPwErrors {server 9}**

fT[fO[f[ä.Ă”f.µ.½fpfXf[fh^á”½.ì”B

**svStatPermErrors {server 10}**

fT[]fo[][]ã,Å"[]¶,μ,½fAfNfZfXCE ^á"½,ì[]"[]B

**svStatSysErrors {server 11}**

fT[]fo[][]ã,Å"[]¶,μ,½fVfXfef€ fGf%[][],ì[]"[]B

**svStatSentBytes {server 12}**

fT[]fo[][],á'—[]M,μ,½fofCf[]"[]B

**svStatRcvdBytes {server 13}**

fT[]fo[][],žó[]M,μ,½fofCf[]"[]B

**svStatAvResponse {server 14}**

fT[]fo[][],áf[][]fNfXfe[]fVf[]",ì I/O —v<[],ð^—[],.é,½,β,É—v,μ,½ŽžŠŎ,ì•½<İ'ı (f~fŠ•b'P^Ê)  
(,½,Æ,ı,ı[]ANCB ,áfT[]fo[][],É"ž'...,μ,½•½<İžžŠŎ)[]B

**svSecurityMode {server 15}**

fT[]fo[][]ã,ŽÅ[]s't,ıfZfıf...fŠfefB,ıží—b[]B

**svUsers {server 16}**

fT[]fo[][],á"~žž,ÉfTfı[]f[]g,Å,«,éf[]fU[][],ì[]"[]B

**svStatReqBufsNeeded {server 17}**

fT[]fo[][],á'Ç%[]Áfofbftf@,ð—v<[],μ,½%[]ň[]"[]B

**svStatBigBufsNeeded {server 18}**

fNf%[]fCfAf[]fg—v<[],ì^—[]'t,É[]AfT[]fo[][],á'âCE^fofbftf@,ð•K—v,Æ,μ,½,áŠ,,è"—,Ä,ç,ê,Ê,©,Á,½%[]ň[]"[]B

**svSessionNumber {server 19}**

fT[]fo[][]ã,ıfZfbfVf[]",ì[]"[]B

**svSessionTable {server 20}**

fNf%[]fCfAf[]fg,áfT[]fo[][],Æ,ıŠŎ,ÅCE»[]ÝžÅ[]s't,ıfZfbfVf[]",É'ı%ž,ı,éfZfbfVf[]" fGf"fgfŠ,ı^è—[]B

**svSessionEntry {svSessionTable 1}**

fT[]fo[][]ã,ÅCE»[]ÝŠm—š,³,è,Ä,ç,éfZfbfVf[]"[]B

**svSesClientName {svSessionEntry 1}**

fZfbfVf[]",ðŠm—š,μ,½fŠf,[]f[]g fRf"fsf...[]f^,ı-¼'O[]B

**svSesUserName {svSessionEntry 2}**

CE»[]Ý,ıfZfbfVf[]",ÅfAfNfefBfu,ÉfT[]fo[][]ž'CE¹,Ŏ,ì[]Ú'±[]"[]B

**svSesNumConns {svSessionEntry 3}**

CE»[]Ý,ıfZfbfVf[]",ÅfAfNfefBfu,ÉfT[]fo[][]ž'CE¹,Ŏ,ì[]Ú'±[]"[]B

**svSesNumOpens {svSessionEntry 4}**

CE»[]Ý,ıfZfbfVf[]",ÅŠ,©,è,Ä,ç,éf[]f@fCf<[]AfffofCfX[]A,ı,æ,Ñf[]pfCfv,ì[]"[]B

**svSesTime {svSessionEntry 5}**

CE»[]Ý,ıfZfbfVf[]",áŠžn,³,è,Ä,©,ç,ìCEo%[]ßžžŠŎ (•b'P^Ê)[]B

**svSesIdleTime {svSessionEntry 6}**

fZfbfVf#f" ,lfAfCfhf<ŽžŠÖ (•b'P^Ê)□B

**svClientType {svSessionEntry 7}**

fZfbfVf#f" ,đŠm—š,μ,½fNf%oofCfAf"fg,ìŽí—b□B

**svSesState {svSessionEntry 8}**

Ĉ»□Ý,ìfZfbfVf#f" ,ì□ó'Ô (netSessionDel ,đŽg,Á,ĀfAfNfefBfu,ĚfZfbfVf#f" ,ì□ó'Ô,đ deleted ,É□Ý'è,·,é,ĀfAfNf%oofCfAf"fg fZfbfVf#f" ,āí□œ,³,ê,Û,·□BfZfbfVf#f" ,ì□ó'Ô,đ active ,É□Ý'è,·,é,± ,Ā,Í,Ā,«,Û,¹,ñ)□B

**svAutoDisconnects {server 21}**

fAfNfefBfu,Ā,í,È,ç,½,βfT□[fo□[ ,āŽ©“®“l,É□Ø'f,μ,½fZfbfVf#f" ,ì□"□B

**svDisConTime {server 22}**

fAfCfhf< fZfbfVf#f" ,đ□Ø'f,·,é'Ö,ĚfT□[fo□[ ,ā'Ö<@,·,é•b□"□B

**svAuditLogSize {server 23}**

fT□[fo□[ ,ìŠĀ□, f□fO,ì□Ā'āfTfCfY (KB 'P^Ê)□B

**svUserNumber {server 24}**

fT□[fo□[□ā,ĚfAfjfEf"fg,đŽ□,Ā,Ā,ç,éft□[fU□[ ,ì□"□B

**svUserTable {server 25}**

fT□[fo□[□ā,lfAfNfefBfu,Ěft□[fU□[ fAfjfEf"fg,ìfe□[fuf<□B

**svUserEntry {svUserTable 1}**

fT□[fo□[□ā,ìft□[fU□[ fAfjfEf"fg□B

**svUserName {svUserEntry 1}**

ft□[fU□[ fAfjfEf"fg,ì-¼'O□B

**svShareNumber {server 26}**

fT□[fo□[□ā,ì<α—LŽ'Ĉ¹,ì□"□B

**svShareTable {server 27}**

fT□[fo□[□ā,ì<α—LŽ'Ĉ¹,ìfe□[fuf<□B

**svShareEntry {svShareTable 1}**

fT□[fo□[□ā,ì'P^è<α—LŽ'Ĉ¹,É'Í%ž,·,éfe□[fuf<□B

**svShareName {svShareEntry 1}**

<α—LŽ'Ĉ¹,ì-¼'O□B

**svSharePath {svShareEntry 2}**

<α—LŽ'Ĉ¹,ìf□[fjf<-¼□B

**svShareComment {svShareEntry 3}**

<α—LŽ'Ĉ¹,ĚŠÖ~A•t,·,ç,ê,½fRf□f"fg□B

**svPrintQNumber {server 28}**

fT[]fo[]ä,lfvfŠf“f^‘Ò,ž[]s—ñ,ì”[]B

**svPrintQTable {server 29}**

fT[]fo[]ä,lfvfŠf“f^‘Ò,ž[]s—ñ,lf[]fuf<[]B

**svPrintQEntry {svPrintQTable 1}**

fT[]fo[]ä,ì‘P^è,lfvfŠf“f^‘Ò,ž[]s—ñ,É‘í%ž,·,éfe[]fuf< fGf“fgfŠ[]B

**svPrintQName {svPrintQEntry 1}**

fvfŠf“f^‘Ò,ž[]s—ñ,ì-¼‘O[]B

**svPrintQNumJobs {svPrintQEntry 2}**

CE»[]ÝfvfŠf“f^,É“ü,Á,Ä,č,éfWf#fu,ì”[]B

f00[fNfXfe[fVf#f" fOf<[fv

**wkstaStatSessStarts {workstation 1}**

f00[fNfXfe[fVf#f",aŠjŽn,μ,½fZfbfVf#f",ì"0B

**wkstaStatSessFails {workstation 2}**

f00[fNfXfe[fVf#f",aŠ,"s,μ,½fZfbfVf#f",ì"0B

**wkstaStatUses {workstation 3}**

f00[fNfXfe[fVf#f",aŠjŽn,μ,½Ú'±,ì"0B

**wkstaStatUseFails {workstation 4}**

f00[fNfXfe[fVf#f",aŠ,"s,μ,½Ú'±,ì"0B

**wkstaStatAutoRecs {workstation 5}**

%0đ0œ,³,ê0A,»,ìĀěŽ©"®"l,É0ĂŠm—š,³,ê,½fZfbfVf#f",ì"0B

**wkstaErrorLogSize {workstation 6}**

f00[fNfXfe[fVf#f" fGf%0[f0fO,ì0Ă'âfTfCfY (KB 'P^Ê)0B

**wkstaUseNumber {workstation 7}**

,±,ìfufWfFfNfg,í0A,Â,Ë,É 0 ,ì'l,đ•Ô,μ,Ü,·0B



fhfCf" fOf<[fv

domPrimaryDomain {domain 1}

fRf"fsf...[f^,@,·,évf%ofCf}fŠ fhfCf",ì-¼'O□B

## DHCP fIfufWfFfNfg

Šé<Æ,ÍARFC 1155-SMI ,É'è<` ,³,è,Ä,ç,Ü,·BfIfufWfFfNfg f^fCfv,ÍARFC 1212 ,É'è<` ,³,è,Ä,ç,Ü,·B·\  
Ž!•¶Žš—ň,ÍARFC 1213 ,É'è<` ,³,è,Ä,ç,Ü,·B

## DHCP MIB fpf%of[f^

### ParDhcpStartTime {DhcpPar 1}

DHCP fT[fof[<N"®ŽžŠÔB

### ParDhcpTotalNoOfDiscovers {DhcpPar 2}

ŽóM,μ,½"CE©f[fbfZ[fW,ì"B

### ParDhcpTotalNoOfRequests {DhcpPar 3}

ŽóM,μ,½—v<[ ,ì"B

### ParDhcpTotalNoOfReleases {DhcpPar 4}

ŽóM,μ,½%øđ•ú,ì"B

### ParDhcpTotalNoOfOffers {DhcpPar 5}

'—M,μ,½'ň<Ÿ (offer) ,ì"B

### ParDhcpTotalNoOfAcks {DhcpPar 6}

'—M,μ,½Šm"F%ž"š,ì"B

### ParDhcpTotalNoOfNacks {DhcpPar 7}

'—M,μ,½"Û'è,ìŠm"F%ž"š,ì"B

### ParDhcpTotalNoOfDeclines {DhcpPar 8}

ŽóM,μ,½Ž«'p,ì"B

## DHCP fXfR[fv fOf<[fv

### ScopeTable {DhcpScope 1}

fT[fof[ ,ª•ÛŽç,μ,Ä,ç,éfTfufIfbfg,ì^ê—B

### sScopeTableEntry {ScopeTable 1}

fTfufIfbfg,É'î%ž,·,é[sB

### SubnetAdd {sScopeTableEntry 1}

fTfufIfbfg fAfhfÇfXB

### NoAddInUse {sScopeTableEntry 2}

Žg—p,³,è,Ä,ç,éfAfhfÇfX,ì"B

### NoAddFree {sScopeTableEntry 3}

—~—p%Å"\\,È<ó,«fAfhfÇfX,ì"B

### NoPendingOffers {sScopeTableEntry 4}

«»ŸA'ňŸó'Ô,É, ,éAfhfEfX (^ěŽž“l,ÉŽg—p,<sup>3</sup>,ê,Ä,č,éAfhfEfX) ,l“B



**ParWinsTotalNoOfQueries {Par 13}**

Žó, Žæ, Á, ½ AE%oi, ì" B

**ParWinsTotalNoOfRel {Par 14}**

Žó, Žæ, Á, ½ %ođ•ú, ì" B

**ParWinsTotalNoOfSuccRel {Par 15}**

□→CE÷, μ, ½ %ođ•ú, ì" B

**ParWinsTotalNoOfFailRel {Par 16}**

—v<CE³, ìfAfhfCEfX,ª,»,-¼'O, ìfAfhfCEfX,Æ^è'v, μ, È, ç, ½, B, ÉŽ, "s, μ, ½ %ođ•ú, ì" B

**ParWinsTotalNoOfSuccQueries {Par 17}**

□→CE÷, μ, ½ AE%oi, ì" B

**ParWinsTotalNoOfFailQueries {Par 18}**

Ž, "s, μ, ½ AE%oi, ì" B

**ParRefreshInterval {Par 19}**

□', «Š, ìŠÓŠu, ì•b□" (fŠftfCEfbfVf...ŠÓŠu,Æ,àCEÁ,Î,ê,Û,·) B

**ParTombstoneInterval {Par 20}**

"pšüšÓŠu, ì•b□" B

**ParTombstoneTimeout {Par 21}**

"pšüf^fCf€fAfEfg, ì•b□" B

**ParVerifyInterval {Par 22}**

CEŸ□, ŠÓŠu, ì•b□" B

**ParVersCounterStartVal\_LowWord {Par 23}**

WINS <N" @Žž, ìfo□[fWf#f" fJfEf"f^, ì%o^Éf□□[fh (Low Word) B

**ParVersCounterStartVal\_HighWord {Par 24}**

WINS <N" @Žž, ìfo□[fWf#f" fJfEf"f^, ìã^Éf□□[fh (High Word) B

**ParRplOnlyWCnfPnrs {Par 25}**

"ñ□□→f□□[fgfi□[,Æ•;□»,ª,Á,«,é,©,Ç,κ,©,đŽw'è,μ,Û,·□Bf[f□,ÉŸ'è,μ,Ä,ç,é,ì,Á,È,¯,ê,ì□AfCEfWfXfgfŠ,É<L□Ú,³,ê,½f□□[fgfi□[,¾,¯,Æ•;□»,đŽÁ□s,Á,«,Û,·(□X□V'É'm,ì'... □M, ìé□‡,đ□œ,) B

**ParStaticDataInit {Par 26}**

□%oŠú%o», " ,æ, Ñ□Ä□□→, ì,Æ,«□Ä"lff□[f^,đ"Ç,ÝŽæ,é,©,Ç,κ,©,đŽw'è,μ,Û,·□Bf□f%□□□[f^ fOf<□[fv"à, ì MIB •ì□",đ□X□V,·,é,Æ□A□Ä□□→,ª□s,í,ê,Û,·□B

**ParLogFlag {Par 27}**

f□fO,đŽú□W,·,é,©,Ç,κ,©,đŽw'è,μ,Û,·□BffftfHf:fg,Á,í□fO,íŽú□W,³,ê,Û,·□B

**ParLogFileName {Par 28}**

ffo ftf@fCf<,lfpfX,đŽw'è,μ,Û,·□B

### ParBackupDirPath {Par 29}

fofbfNfAfbfv fffBfCefNfgfŠ,lfpfX,đŽw'è,μ,Û,·□B

### ParDoBackupOnTerm {Par30}

WINS ,a□l—<sup>1</sup>Žž,Éff□f^fx□fX,đfofbfNfAfbfv,·,é,©,Ç,κ,©,đŽw'è,μ,Û,·□BŽw'è'l,Í 0 (fofbfNfAfbfv,μ,È,ç) ,Û,½,Í 1 (fofbfNfAfbfv,·,é) ,Á,·□B,±,ì'l,đ 1 ,É□Ý'è,μ,Ä,à□AParBackupDirPath ,à<sup>•1</sup>,<sup>1</sup>Ä□Ý'è,μ,Ä,ç,È,ç ,Æ^Ó-j,ª ,è,Û,<sup>1</sup>ñ□B

### ParMigration {Par 31}

WINS fff□f^fx□fX“à,ì□Ä“lfCefR□fh,đ□A□V<K-¼'O“o~^,Æ□d•j,μ,Ä,ç,éŠÖ,Í“®“lfCefR□fh,Æ,μ,ÄŽæ,è^μ,κ ,©,Ç,κ,©,đŽw'è,μ,Û,·□BŽw'è'l,í□A0 (Žæ,è^μ,í,È,ç) ,Û,½,Í 1 (Žæ,è^μ,κ) ,Á,·□B

### WINS fff□f^ ftf@fCf< fOf<□fV

#### DFDatafilesTable {Datafiles 1}

fCefWfXfgfŠ“à,ì \Datafiles fL□[,ì%º,ÄŽw'è,<sup>3</sup>,è,Ä,ç,éff□f^ ftf@fCf<,ì^è—□B,±,è,ç,ìftf@fCf<,í□AWINS fff□f^fx□fX,đ□Ä“l,É□%Šú%»·,·,é,½,β,ÉŽg,ç,Û,·□B

#### dDFDatafileEntry {DFDatafilesTable 1}

ff□f^ ftf@fCf<-¼fCefR□fh□B

#### dDFDatafileIndex {dDFDatafileEntry 1}

ff□f^ ftf@fCf< fe□fuf<“à,ìfGf“fgfŠ,ÉfCf“fffbfNfX,đ•t,¯,é,½,β,É,ì,ÝŽg,í,è,Û,·□B

#### dDFDatafileName {dDFDatafileEntry 2}

□Ä“l,È□%Šú%»·,ÉŽg,κff□f^ ftf@fCf<,ì-¼'O□B

### WINS fvf< fOf<□fV

#### PullInitTime {Pull 1}

WINS ,ì<N“®Žž,¯,æ,Ñ□Ä□□-Žž,É^ø,«□o,μ (pull) ,đŽÀ□s,·,é,©,Ç,κ,©,đŽw'è,μ,Û,·□Bfvf< fOf<□fV,Û,½,ìfVbfVf... fOf<□fV,ì%½,ç,©,ì MIB •Í□“,đ□Ý'è,·,é,Æ□A□Ä□□-ª□s,í,è,Û,·□B

#### PullCommRetryCount {Pull 2}

fvf<•;□»Žž,É'Ê□M,ÉŽ,“s,μ,½□ê□#,ì□ÄŽŽ□sfJfEf“fg,đŽw'è,μ,Û,·□B,± ,è,í□A,»·,ìfp□fJgfí□[,É'í,μ,ÄŽw'è,<sup>3</sup>,è,½ŠÖŠu,ÄŽÀ□s,<sup>3</sup>,è,é□Á'â□ÄŽŽ□s%ñ□“,Á,·□B,»·,ìCEã□AWINS ,ì□Ý'è,<sup>3</sup>,è,½•;□»ŠÖŠu,ª%β,¯,é,Û,Á'âŽ~·,μ,Ä,©,ç□A□ÄŽŽ□s,đ□s,ç,Û,·□B

#### PullPnrTable {Pull 3}

fvf<•;□»·,đŽÀ□s,·,é•K-v,ª ,éfp□fJgfí□[,ì^è—□B

#### pPullPnrEntry {PullPnrTable 1}

fp□fJgfí□[,É'í%ž,μ,Ä,ç,é□s□B

#### PullPnrAdd {pPullPnrEntry 1}

fŠf,□fJg WINS fp□fJgfí□[,ìfAfhfCefX□B

#### PullPnrSpTime {pPullPnrEntry 2}

fVf<•;i»»,ì<N“ @Žž□□,ðŽw’è,μ,Û,·□B

**PullPnrTimeInterval {pPullPnrEntry 3}**

fVf<•;i»»,ìŽžŠÔŠÔŠu,ðŽw’è,μ,Û,·□B

**PullPnrMemberPrec {pPullPnrEntry 4}**

WINS ,©,ç^ø,«□o,³,ê,½“ÁŽêfOf<□[fv,ìf□f“fo□[,É—^,ì,ç,ê,é—D□æCE □Bf□□[ffj<,É“o~^,³,ê,½“ÁŽêfOf<□[fv  
f□f“fo□[,ì—D□æCE ,í□A^ø,«□o,³,ê,½,·,x,Ä,ì•i□»,æ,è□,,É,è,Û,·□B

**PullPnrNoOfSuccRpls {pPullPnrEntry 5}**

ffjEf“f^,ì<N“ @,Û,½,íſſfZfbfg,ìCEä,É WINS ,Å□—CE÷,μ,½•i□»,ì%ñ□”□B

**PullPnrNoOfCommFails {pPullPnrEntry 6}**

‘É□M□áŠQ,ì,½,ß,É WINS ,ÅŽ,“s,μ,½•i□»,ì%ñ□” (ffjEf“f^,ì<N“ @,Û,½,íſſfZfbfg,ìCEä)□B

**PullPnrVersNoLowWord {pPullPnrEntry 7}**

,±,ì WINS ,³□Š—L,μ,Ä,ç,éfCEfR□[fh“à,ì□Å’âfo□[fWfj“”Ô□†,ì%ñ□”Éf□□[fh (Low Word)□B

**PullPnrVersNoHighWord {pPullPnrEntry 8}**

,±,ì WINS ,³□Š—L,μ,Ä,ç,éfCEfR□[fh“à,ì□Å’âfo□[fWfj“”Ô□†,ì□ã^Éf□□[fh (High word)□B

**WINS fVfbfVf... fOf<□[fv**

**PushInitTime {Push 1}**

<N“ @Žž,ÉfVfbfVf... (,Ä,Û,è□A’É’mf□fbfZ□[fW),ðŽÀ□s,·,é,©,Ç,π,©,ðŽw’è,μ,Û,·□B

**PushRplOnAddChg {Push 2}**

fAfhfCEfX•ì□XŽž,É’É’mf□fbfZ□[fW,ð’—□M,·,é,©,Ç,π,©,ðŽw’è,μ,Û,·□B

**PushPnrTable {Push 3}**

fVfbfVf...•i□»,ð<N“ @,·,é WINS fp□[fgfi□[,ì^è—□B

**pPushPnrEntry {PushPnrTable 1}**

WINS fp□[fgfi□[,É’í%ž,μ,Ä,ç,é□s□B

**PushPnrAdd {pPushPnrEntry 1}**

WINS fp□[fgfi□[,ìfAfhfCEfX□B

**PushPnrUpdateCount {pPushPnrEntry 2}**

fVfbfVf... f□fbfZ□[fW,Æ,É,é□X□V,ì%ñ□”□B

**WINS Cmd fOf<□[fv**

**CmdPullTrigger {Cmd 1}**

,±,ì•i□”,ð□Ý’è,·,é,Æ□AWINS ,í□AIP fAfhfCEfX,ÅŽ~•É,³,ê,éfŠf,□[fg WINS fT□[fo□[,©,ç•i□»,ðfVf<  
fCf“,μ,Û,·□B

**CmdPushTrigger {Cmd 2}**

,±,ì•i□”,ð□Ý’è,·,é,Æ□AWINS ,í□AIP fAfhfCEfX,ÅŽ~•É,³,ê,éfŠf,□[fg WINS  
fT□[fo□[,É’É’mf□fbfZ□[fW,ðfVfbfVf...μ,Û,·□B

**CmdDeleteWins {Cmd 3}**

,±,ì•ï",ðÿ'è,·,é,ÆAWINS fT[fó[.É'®,·,éï•ñ (ff[f^ fCfR[fhAfRf"fefLfXfgî•ñ) ,a,·,×,Äf[fjf< WINS fT[fó[.©,çíœ,³,ê,Û,·B,±,ì•ï",íAŠ—LŽÒ,ÆfAfhfCfX,Æ,lf}fbfsf"fo fe[fuf<,a,ç,Á,í,ç,É<B,ç ,Æ,«,¾,žg—p,μ,Û,·BŠÇ—,μ,Ä,ç,é WINS ,É'®,·,éï•ñ,ð,·,×,Äíœ,·,é,±,Æ,í,Á,«,Û,¹,ñB

**CmdDoScavenging {Cmd 4}**

,±,ì•ï",ðÿ'è,·,é,ÆAWINS ,í'í',ðŽÀ[s,μ,Û,·B

**CmdDoStaticInit {Cmd 5}**

,±,ì•ï",ðÿ'è,·,é,ÆAWINS ,íA•ï",ÉŽw'è,μ,½ftf@fCf<,ðŽg,Á,ÄÄ"l,È%Šú%»,ðŽÀ[s,μ,Û,·B0 ,ðŽw'è,·,é,ÆAWINS ,íAfCfWfXfgfŠ,ÉŽw'è,μ,Ä, ,eftf@fCf<,ðŽg,Á,ÄÄ"l,È%Šú%»,ðŽÀ[s,μ,Û,· (ftf@fCf<-¼,íf[f^ ftf@fCf< fe[fuf<,ðŽg,Á,Ä"Ç,Ý',«,Ä,«,Û,·)B

**CmdNoOfWrkThds {Cmd 6}**

WINS "à,lf[fj[f XfCfbfh,ì",ð"Ç,ÝŽæ,è,Û,·B

**CmdPriorityClass {Cmd 7}**

WINS ,ì—Dæ±^ÉfNf%ofX,arÉí,©,ð^É,©,ð"Ç,ÝŽæ,è,Û,·B

**CmdResetCounters {Cmd 8}**

ffEf" f^,ðšfZfbfg,μ,Û,·B'l,í-³Ž<,³,ê,Û,·B

**CmdDeleteDbRecs {Cmd 9}**

,±,ì•ï",ðÿ'è,·,é,ÆAWINS fT[fó[.É'®,·,éff[f^ fCfR[fh,a,·,×,Äf[fjf< WINS fT[fó[.©,çíœ,³,ê,Û,·Bff[f^ fCfR[fh,¾,·,aríœ,³,ê,Û,·B

**CmdDRPopulateTable {Cmd 10}**

IP fAfhfCfX,arñ<Ý,³,ê,Ä,ç,é WINS fT[fó[.ífCfR[fh,ðŽæ"¾,μ,Û,·B,±,ì•ï",ðÿ'è,·,é,ÆAff[f^ fCfR[fh fe[fuf<,ar¼,ç,Éíœ,³,ê,Û,·B

**CmdDRDataRecordsTable {Cmd 11}**

ff[f^ fCfR[fh,ðŠi"[·,éfe[fuf<BfCfR[fh,í-¼'O,ÄŽ«[±,É•Ä,×'Ö,í,ç,è,Û,·B,± ,ife[fuf<,íA^è'èšúŠÖ,¾,·flfffbVf...,ÉŠi"[³,ê,Û,· (WINS ,lf[fó[fwfbfh,ðE,·,ç,·,½,B)Bfe[fuf<,ðÄíœ,·,é,É,íACmdDRPopulateTable MIB •ï",ðÿ'è,μ,Û,·B

**CmdDRRecordEntry {CmdDRDataRecordsTable 1}**

CmdDRPopulateTable ÿ'èŽž,ÉfAfhfCfX,arŽw'è,³,ê,½ WINS fT[fó[.arŠ—L,μ,Ä,ç,éff[f^ fCfR[fhB

**CmdDRRecordName {cCmdDRRecordEntry 1}**

fCfR[fh"à,í-¼'O B

**CmdDRRecordAddress {cCmdDRRecordEntry 2}**

fCfR[fh,lfAfhfCfX (1 ,Ä,Û,½,í•;")BfCfR[fh,ar}f<fz[f€ fCfR[fh,©AfCf" f^ [flfbfg fOf<[fv,ìœ±,íAfAfhfCfX,íí,É,È,Ä,Ä±ŽÝ•Ö,³,ê,Û,·BŠefyA,íAfí[fí[WINS fT[fó[.Æ,»,è,É'±,- fRj"fsf...[f^,Û,½,ífCf" f^ [flfbfg fOf<[fv f"fo[.lfAfhfCfX,©,çíœ,³,ê,Ä,ç ,Û,·BfCfR[fh,íA•K, flfbfgfN fofCfg±~ ,Ä•Ö,³,ê,Û,·B

**CmdDRRecordType {cCmdDRRecordEntry 3}**

fCfR[fh,íží—pB^èÓ (unique)Af}f<fz[f€A•W€fOf<[fvA,Û,½,ífCf" f^ [flfbfg fOf<[fvB



**CmdDRRecordPersistenceType {cCmdDRRecordEntry 4}**

fCefR[fh,ìŽ±«,ìŽí—pBÄ“l,Ü,½,í“@“lB

**CmdDRRecordState {cCmdDRRecordEntry 5}**

fCefR[fh,ìó’ÔBfAfNfefBfuA%đ•úA,Ü,½,í“pŠüB

**CmdWinsVersNoLowWord {Cmd 12}**

fCefR[fh,ìfo[fWf#“”Ô+ffEf“f^,ì%º^Êf[fh (Low Word)B

**CmdWinsVersNoHighWord {Cmd 13}**

fCefR[fh,ìfo[fWf#“”Ô+ffEf“f^,ìã^Êf[fh (High Word)B

